



Spectra T950V Library

User Guide



Copyright

Copyright © 2018 Spectra Logic Corporation. All rights reserved. This item and the information contained herein are the property of Spectra Logic Corporation.

Notices

Except as expressly stated herein, Spectra Logic Corporation makes its products and associated documentation on an “AS IS” BASIS, WITHOUT WARRANTY OF ANY KIND, EITHER EXPRESSED OR IMPLIED, INCLUDING BUT NOT LIMITED TO THE IMPLIED WARRANTIES OF MERCHANTABILITY OR FITNESS FOR A PARTICULAR PURPOSE, BOTH OF WHICH ARE EXPRESSLY DISCLAIMED. In no event shall Spectra Logic be liable for any loss of profits, loss of business, loss of use or data, interruption of business, or for indirect, special, incidental or consequential damages of any kind, even if Spectra Logic has been advised of the possibility of such damages arising from any defect or error.

Information furnished in this manual is believed to be accurate and reliable. However, no responsibility is assumed by Spectra Logic for its use. Due to continuing research and development, Spectra Logic may revise this publication from time to time without notice, and reserves the right to change any product specification at any time without notice.

Trademarks

BlackPearl, BlueScale, CC, Spectra, SpectraGuard, Spectra Logic, TeraPack, TFinity, TranScale, and Verde are registered trademarks of Spectra Logic Corporation. ArchiveGrade and ArcticBlue are trademarks of Spectra Logic Corporation. All rights reserved worldwide. All other trademarks and registered trademarks are the property of their respective owners.

Part Number

90940154 Revision A

Revision History

Revision	Date	Description
----------	------	-------------

A	February 2018	Initial release.
---	---------------	------------------

- Notes:**
- To make sure you have the most current version of this guide check the Spectra Logic Technical Support portal at support.spectralogic.com/documentation/user-guides/.
 - To make sure you have the release notes for the most current version of the BlueScale software, check the Spectra Logic Technical Support portal at support.spectralogic.com/documentation/release-notes/.
 - You must sign into the portal before viewing Release Notes. The release notes contain updates to the *User Guide* since the last time it was revised.

**End User
License
Agreement****1. READ CAREFULLY**

YOU SHOULD READ THE FOLLOWING TERMS AND CONDITIONS BEFORE ACCEPTING THIS END-USER LICENSE AGREEMENT ("EULA"). THIS EULA IS A LEGAL AGREEMENT BETWEEN YOUR ORGANIZATION, THE END USER, AND SPECTRA LOGIC CORPORATION ("SPECTRA") FOR THE SPECTRA SOFTWARE PRODUCT WHICH INCLUDES COMPUTER SOFTWARE AND MAY INCLUDE ASSOCIATED MEDIA, PRINTED MEDIA, AND "ONLINE" OR ELECTRONIC DOCUMENTATION (COLLECTIVELY, "SOFTWARE PRODUCT"). BY INSTALLING, COPYING, OR OTHERWISE USING THE SOFTWARE PRODUCT, YOU AGREE TO BE BOUND BY THE TERMS OF THIS EULA. IF YOU DO NOT AGREE TO THE TERMS OF THIS EULA, YOU MAY NOT INSTALL, COPY, DOWNLOAD OR USE THE SOFTWARE PRODUCT. YOU AGREE THAT YOUR USE OF THE SOFTWARE ACKNOWLEDGES THAT YOU HAVE READ THIS AGREEMENT, UNDERSTAND IT, AND AGREE TO BE BOUND BY ITS TERMS AND CONDITIONS.

2. OWNERSHIP

It is understood and agreed that Spectra Logic Corporation, a Delaware corporation with offices at 6285 Lookout Road, Boulder, CO 80301 ("Licensor") is the owner of all right, title and interest to the Software Product, regardless of the media or form of the original download, whether by the World Wide Web, disk or otherwise. You, as licensee ("Licensee") through your downloading, installing, copying or use of this product do not acquire any ownership rights to the Software Product.

3. GENERAL

The Software Product is licensed, not sold, to you by Spectra for use only under the terms of this EULA. The Software Product is protected by copyright laws and international copyright treaties, as well as other intellectual property laws and treaties. The rights granted herein are limited to Spectra's and its licensors' intellectual property rights in the Software Product and do not include any other patents or intellectual property rights. The terms of this EULA will govern any software upgrades provided by Spectra that replace and/or supplement the original Software Product, unless such upgrade is accompanied by a separate license in which case the terms of that license will govern.

4. SOFTWARE PRODUCT

The Software Product, as used in this EULA, means, collectively and/or as applicable:

- The Software Product package;
- Any and all contents, components, attachments, software, media, and code with which this Agreement is provided and delivered;
- Any and all images, photographs, art, art work, clip art, fonts or other artistic works (the "Art Work");
- Related explanatory written materials and instructions, and any other possible documentation related thereto ("Documentation"); and
- Upgrades, modified versions, updates, additions and copies of the Software Product (the "Upgrades"), if any, licensed to by Spectra under this EULA.

5. GRANT OF LICENSE AND RESTRICTIONS

- A. Spectra grants you a non-exclusive, non-transferable End-User license right to install the Software Product solely for the purpose for which it was created.
- B. Unless provided otherwise in the Documentation or by prior express written consent of Spectra, you shall not display, modify, reproduce and distribute any Art Work, or portion(s) thereof, included with or relating to the Software Product, if any. Any such authorized display, modification, reproduction and distribution shall be in full accord with this EULA. Under no circumstances will your use, display, modification, reproduction and distribution of the Art Work give you any Intellectual Property or Proprietary Rights of the Art Work. All rights, title, and interest belong solely to Spectra.
- C. Except for the initial loading of the Software Product, you shall not, without Spectra's express written consent:
 - Copy or reproduce the Software Product; or
 - Modify, adapt, or create derivative works based on the Software Product or any accompanying materials.

6. DESCRIPTION OF OTHER RIGHTS AND LIMITATIONS

- A. Spectra will provide you with support services related to the Software Product ("Support"). Such Support will be provided in accordance with the Spectra Master Support Agreement, available for download and viewing on the Spectra Corporate Web site. Use of Support is governed by this EULA and Spectra's Master Support Agreement,
- B. Any supplemental software, code, content, or media provided to you in the course of Support shall be considered part of the Software Product and subject to the terms and conditions of this EULA.
- C. Spectra retains all right, title, and interest in and to the Software Product, and any rights not granted to you herein are reserved by Spectra. You hereby expressly agree not to extract information, reverse engineer, disassemble, decompile, or translate the Software Product, or otherwise attempt to derive the source code of the Software, except to the extent allowed under any applicable law. In the event that such activities are permitted by applicable law, any information you, or your authorized agent, discover shall be promptly disclosed to Spectra and shall be deemed the confidential information of Spectra.
- D. You shall not modify, sublicense, assign, or transfer the Software Product or any rights under this EULA, except as expressly provided in this EULA. Any attempt to other sublicense, assign, or transfer any of the rights, duties, or obligations will be void.
- E. You may permanently transfer all of your rights under this EULA, provided you retain no copies. The other party must agree to accept the terms and conditions of the EULA.

7. ALL RESERVED

All rights not expressly granted herein are reserved by Spectra.

8. TERM

- A.** This License is effective until terminated. Licensee may terminate it at any time by destroying the Software Product with all copies, full or partial, and removing all of its component parties.
- B.** Your rights under this EULA will terminate automatically without notice from Spectra if you fail to comply with any term(s) or condition(s) of this EULA. In such event, no notice shall be required by Spectra to effect such termination.
- C.** Upon termination of this EULA, you shall cease all use of the Software Product and destroy all copies, full or partial, together with all backup copies, modifications, printed or written materials, and merged portions in any form and remove all component parts of the Software Product.

9. INTELLECTUAL PROPERTY RIGHTS

- A.** Spectra shall retain all right, title, and interest in the Software Product and to any modifications or improvements made thereto, and any upgrades, updates or Documentation provided to End User. End User will not obtain any rights in the Software Product, its updates, upgrades, and Documentation, as a result of its responsibilities hereunder.
- B.** End User acknowledges Spectra's exclusive rights in the Software Product and that the Software Product is unique and original to Spectra and that Spectra is owner thereof. Unless otherwise permitted by law, End User shall not, at any time during or after the effective Term of the Agreement, dispute or contest, directly or indirectly, Spectra's exclusive right and title to the Software Product or the validity thereof.

10. U.S. GOVERNMENT END USERS

The Software Product and related documentation are "Commercial Items," as that term is defined at 48 C.F.R. §2.101, consisting of "Commercial Computer Software" and "Commercial Computer Software Documentation," as such terms are used in 48 C.F.R. §12.212 or 48 C.F.R. §§227.7202-1 through 227.7202-4, as applicable. The Commercial Computer Software and Commercial Computer Software Documentation are being licensed to U.S. Government end users (a) only as Commercial Items and (b) with only those rights as are granted to all other End Users pursuant to the terms and conditions herein. Unpublished rights reserved under the copyright laws of the United States.

11. EXPORT LAW ASSURANCES

You may not use or otherwise export or re-export the Software Product except as authorized by United States law and the laws of the jurisdiction in which the Software Product was obtained. In particular, but without limitation, the Software Product may not be exported or re-exported (a) into (or to a nation or resident of) any U.S. embargoed countries or (b) to anyone on the U.S. Treasury Department's list of Specially Designated Nationals or the U.S. Department of Commerce Denied Person's List or Entity List. By installing or using any component of the Software Product, you represent and warrant that you are not located in, under control of, or a national or resident of any such country or on any such list.

12. DISCLAIMER OF WARRANTIES

YOU EXPRESSLY ACKNOWLEDGE AND AGREE THAT USE OF THE SOFTWARE PRODUCT IS AT YOUR SOLE RISK AND THAT THE ENTIRE RISK AS TO SATISFACTORY QUALITY, PERFORMANCE, ACCURACY AND EFFORT IS WITH YOU. TO THE MAXIMUM EXTENT PERMITTED BY APPLICABLE LAW, AND EXCEPT AS MAY BE STATED IN THE SPECTRA MASTER SERVICE AGREEMENT, THE SOFTWARE PRODUCT IS PROVIDED "AS IS," WITH ALL FAULTS AND WITHOUT WARRANTY OF ANY KIND, AND SPECTRA AND SPECTRA'S AFFILIATES (COLLECTIVELY REFERRED TO AS "SPECTRA" FOR THE PURPOSES OF SECTIONS 10 AND 11) HEREBY DISCLAIM ALL WARRANTIES AND CONDITIONS WITH RESPECT TO THE SOFTWARE PRODUCT, EITHER EXPRESS, IMPLIED OR STATUTORY, INCLUDING, BUT NOT LIMITED TO, THE IMPLIED WARRANTIES AND/OR CONDITIONS OF MERCHANTABILITY, OF SATISFACTORY QUALITY, OF FITNESS FOR A PARTICULAR PURPOSE, OF ACCURACY, OF QUIET ENJOYMENT, AND NON-INFRINGEMENT OF THIRD-PARTY RIGHTS. SPECTRA DOES NOT WARRANT AGAINST INTERFERENCE WITH YOUR ENJOYMENT OF THE SOFTWARE PRODUCT THAT THE FUNCTIONS CONTAINED IN THE SOFTWARE PRODUCT WILL MEET YOUR REQUIREMENTS, THAT THE OPERATION OF THE SOFTWARE PRODUCT WILL BE UNINTERRUPTED OR ERROR-FREE, OR THAT DEFECTS IN THE SOFTWARE PRODUCT WILL BE CORRECTED. NO ORAL OR WRITTEN INFORMATION OR ADVICE GIVEN BY SPECTRA OR A SPECTRA AUTHORIZED REPRESENTATIVE SHALL CREATE A WARRANTY. SOME JURISDICTIONS DO NOT ALLOW THE EXCLUSION OF IMPLIED WARRANTIES OR LIMITATION ON APPLICABLE STATUTORY RIGHTS OF A CONSUMER, SO THE ABOVE EXCLUSION AND LIMITATIONS MAY NOT APPLY TO YOU.

13. LIMITATION OF LIABILITY

TO THE MAXIMUM EXTENT PERMITTED BY APPLICABLE LAW, IN NO EVENT SHALL SPECTRA, ITS AFFILIATES OR LICENSEES, BE LIABLE FOR ANY SPECIAL, INCIDENTAL, INDIRECT, OR CONSEQUENTIAL DAMAGES WHATSOEVER (INCLUDING, WITHOUT LIMITATION, DAMAGES FOR LOSS OF BUSINESS PROFITS, BUSINESS INTERRUPTION, LOSS OF BUSINESS INFORMATION, OR ANY OTHER PECUNIARY LOSS) ARISING OUT OF THE USE OF OR INABILITY TO USE THE SOFTWARE PRODUCT OR THE PROVISION OF OR FAILURE TO PROVIDE SUPPORT SERVICES, EVEN IF SPECTRA HAS BEEN ADVISED OF THE POSSIBILITY OF SUCH DAMAGES. IN ANY CASE, SPECTRA'S ENTIRE LIABILITY UNDER ANY PROVISION OF THIS EULA SHALL BE LIMITED TO THE AMOUNT ACTUALLY PAID BY YOU FOR THE SOFTWARE PRODUCT; PROVIDED HOWEVER, IF YOU HAVE ENTERED INTO A MASTER SUPPORT AGREEMENT, SPECTRA'S ENTIRE LIABILITY REGARDING SUPPORT SERVICES SHALL BE GOVERNED BY THE TERMS OF THAT AGREEMENT. BECAUSE SOME STATES AND JURISDICTIONS DO NOT ALLOW THE EXCLUSION OR LIMITATION OF LIABILITY, THE ABOVE LIMITATION MAY NOT APPLY TO YOU.

14. CONTROLLING LAW AND SEVERABILITY

This EULA will be governed by and construed in accordance with the laws of the State of Colorado, as applied to agreements entered into and to be performed entirely within Colorado between Colorado residents. This EULA shall not be governed by the United Nations Convention on Contracts for the International Sale of Goods, the application of which is expressly excluded. If for any reason a court of competent jurisdiction finds any provision, or portion thereof, to be unenforceable, the remainder of this EULA shall continue in full force and effect.

Contacting Spectra Logic

To Obtain General Information

Spectra Logic Website: www.spectralogic.com

United States Headquarters

Spectra Logic Corporation
6285 Lookout Road
Boulder, CO 80301
USA
Phone: 1.800.833.1132 or 1.303.449.6400
International: 1.303.449.6400
Fax: 1.303.939.8844

European Office

Spectra Logic Europe Ltd.
329 Doncastle Road
Bracknell
Berks, RG12 8PE
United Kingdom
Phone: 44 (0) 870.112.2150
Fax: 44 (0) 870.112.2175

Spectra Logic Technical Support

Technical Support Portal: support.spectralogic.com

United States and Canada

Phone:
Toll free US and Canada: 1.800.227.4637
International: 1.303.449.0160

Europe, Middle East, Africa

Phone: 44 (0) 870.112.2185
Deutsch Sprechende Kunden
Phone: 49 (0) 6028.9796.507
Email: spectralogic@stortrec.de

Mexico, Central and South America, Asia, Australia, and New Zealand

Phone: 1.303.449.0160

Spectra Logic Sales

Website: shop.spectralogic.com/

United States and Canada

Phone: 1.800.833.1132 or 1.303.449.6400
Fax: 1.303.939.8844
Email: sales@spectralogic.com

Europe

Phone: 44 (0) 870.112.2150
Fax: 44 (0) 870.112.2175
Email: eurosales@spectralogic.com

To Obtain Documentation

Spectra Logic Website: support.spectralogic.com/documentation

Contents

About This Guide 18

INTENDED AUDIENCE	18
PRODUCT STATUS	18
RELATED INFORMATION	18

Chapter 1 – Library Overview 22

LIBRARY FEATURES	23
BlueScale Software	23
Library Components	27
Interior Components	30
Main and Drive Expansion Frame Rear Components	32
Media Expansion Frames	36
Operator Panel and Touch Screen	37
TeraPack Access Port (TAP)	38
Spectra Library Control Modules (LCM and RCM)	39
Exporting Controllers	42
Tape Drives	44
TERAPACK CARTRIDGE HANDLING	46
LIBRARY EXPANSION AND UPGRADES	47

Chapter 2 – Architecture Overview 48

MEDIA POOLS	49
LIBRARY PARTITIONS	50
Storage Partitions	52
Cleaning Partitions and Auto Drive Clean	53
DRIVE AND MEDIA FRAMES	54
COMPONENT IDENTIFIERS	55
RIM2 Identifiers	57
Drive Identifiers	57
FIBRE CHANNEL CONNECTIVITY	58
Robotic Controller Connectivity	59
Drive Connectivity	64

HIGH-AVAILABILITY CONFIGURATIONS	65
Redundant Connectivity	66
Global Spare Drives	69
Redundant Power Supplies	69
Chapter 3 – Introducing the BlueScale User Interface	70
OVERVIEW OF THE BLUESCALE USER INTERFACE	71
Access Options	71
User Interface Features	73
Library Management	81
USING THE BLUESCALE USER INTERFACE	82
Log Into the User Interface	82
Log Off or Switch Users	86
Enter Information on Screens	87
Chapter 4 – Configuring the Library	89
CONFIGURING LIBRARY USERS	90
Understanding User Groups and Security	90
Add a New User	91
Modify an Existing User	93
Delete an Existing User	93
ACCESSING THE SYSTEM SETUP SCREEN	93
ENABLING BLUESCALE SOFTWARE SUPPORT, OPTIONS, AND UPGRADES	95
Enter Activation Keys	97
Add Options	98
CONFIGURING THE GLOBAL SYSTEM SETTINGS	99
Configure the System Settings	100
Configure Network Settings	104
Configure Mail Users	106
Enable Email for the Auto Configuration Save File	108
Set the Date and Time	110

CONFIGURING OPTIONAL LIBRARY SETTINGS	111
Install a Security Certificate and Authentication Key	112
Configure Routine Maintenance	115
Enable and Configure SNMP	116
Configure Controller Failover	119
Configure Emulation	122
Configure Barcode Reporting	124
Configure a Package Server	129
Modify Auto Download Options	132
Configure Rotation Manager	133
BACKING UP THE LIBRARY CONFIGURATION	135
Use Automatic Backup of the Library Configuration	136
Use Manual Backup of the Library Configuration	136

Chapter 5 – Operating the Library **140**

CONTROLLING THE LIBRARY POWER	141
Power On the Library	141
Power Off the Library	143
MONITORING YOUR LIBRARY	145
Check and Respond to Messages	146
Use Performance Metrics	149
View Robot Utilization Information	152
View Drive Status Information	153
View a Partition's World Wide Name	156
USING A USB DEVICE	157
Continuing Backups While Using a USB Device	157
Connect a USB Device to the Library	158

Chapter 6 – Configuring and Managing Partitions **159**

PARTITION CONFIGURATION OVERVIEW	160
Partition Types and Requirements	160
PREPARING TO CONFIGURE PARTITIONS	165
CREATING A CLEANING PARTITION	166
Define the Initial Cleaning Partition Settings	167
Configure the Chambers for the Partition	168

CREATING A STORAGE PARTITION	169
Define the Initial Storage Partition Settings	169
Select the Robotic Control Path	172
Assign Global Spare Drives	173
Allocate Chambers and Drives	176
Enable and Configure MLM PreScan and PostScan	178
Select the Encryption Mode	181
Configure the Drive Fibre Channel Addressing	183
Specify the Partition Users	184
Configure the Robotic Path Visibility	184
Configure the Port Addressing for the Controllers	185
CONFIRMING AND SAVING THE PARTITION SETTINGS	187
MODIFYING AN EXISTING PARTITION	190
DELETING A PARTITION	194
Delete a Partition	195

Chapter 7 – Importing and Exporting Cartridges 196

PREPARING CARTRIDGES FOR USE	197
Cartridge Guidelines and Requirements	197
Prepare the Cartridges for Use	199
M8 Media	200
IMPORT AND EXPORT OVERVIEW	201
Requirements	201
Restrictions	201
IMPORTING INTO A STORAGE OR CLEANING PARTITION	202
Import Requirements	202
Prepare the Storage Partition or the Cleaning Partition	205
Import the Magazines	206
Prepare the Entry/Exit Pool	209
EXPORTING OR EXCHANGING MAGAZINES AND CARTRIDGES	209
Prepare for the Export or Exchange	210
Export Magazines from a Partition	211
Exchange Magazines or Cartridges in a Partition	212
Export or Exchange Expired Cleaning Cartridges	213
USING THE ADVANCED IMPORT/EXPORT OPTIONS	216
Manually Create a Move Queue	216
Upload a Move Queue	219
Start the Moves	222
UPDATING THE STORAGE MANAGEMENT SOFTWARE INVENTORY	222

Chapter 8 – Using the Cartridge Inventory	223
UNDERSTANDING THE CARTRIDGE INVENTORY	224
VIEWING AND DOWNLOADING THE CARTRIDGE INVENTORY	224
View the Cartridge Inventory for a Location	225
Download the Cartridge Inventory	227
LOCATING A SPECIFIC CARTRIDGE	231
MOVING CARTRIDGES WITHIN A PARTITION	231
Move Cartridges Using the BlueScale Inventory Screen	232
Move Cartridges Using an ASCII Move File	237
 Chapter 9 – Configuring and Using Media Lifecycle Management	 243
BLUESCALE MEDIA LIFECYCLE MANAGEMENT	244
Spectra Certified MLM-Enabled Media	244
Automatic Media Discovery	245
Media Tracking and Reporting	247
MLM PreScan and PostScan	250
Additional MLM Features	251
ENABLING MLM AND CONFIGURING GLOBAL SETTINGS	253
Enable MLM and Configure Settings	253
Configure How Storage Capacity Displays	257
Configure PostScan Blackout Periods	258
USING MEDIA LIFECYCLE MANAGEMENT	260
Add Cartridges to the MLM Database	260
Discover Cartridges Manually	262
Stop the Discovery Process	264
USING PRESCAN	264
USING POSTSCAN	265
Operational Overview	265
Address Requirements for Use	269
Enable PostScan	270
Request a Manual PostScan	270
Pause the PostScan Process	272
USING MLM REPORTING	273
Generate MLM Reports	273
Save an MLM Report	278
Override a Poor Cartridge Health Report	280

MANAGING THE MLM DATABASE	281
Back Up the MLM and DLM Databases	282
Verify the Database Backup File	284
Delete MLM Records From the Database	284
Download the MLM Database for Analysis and Archival	287
Chapter 10 – Using Drive Lifecycle Management	288
BLUESCALE DRIVE LIFECYCLE MANAGEMENT	288
MONITORING DRIVE HEALTH USING DLM	289
Using the Drive Health Icons	291
Viewing and Saving a Detailed Drive Health Report	293
DOWNLOADING THE DLM DATABASE	295
Chapter 11 – Configuring and Using AutoSupport	297
AUTOSUPPORT OVERVIEW	297
CONFIGURING AUTOSUPPORT	300
Configure Mail Recipients	300
Configure AutoSupport Profiles	301
Configure Alarms	305
Configure Log Set Forwarding	307
USING AUTOSUPPORT	308
Create New Support Tickets	308
Update Existing Support Tickets	312
Chapter 12 – Library Troubleshooting	314
TROUBLESHOOTING LIBRARY PROBLEMS	315
TROUBLESHOOTING LIBRARY INITIALIZATION ISSUES	315
TROUBLESHOOTING BLUESCALE USER INTERFACE ISSUES	316
TROUBLESHOOTING MLM ISSUES	319
TROUBLESHOOTING ENCRYPTION ISSUES	320
RESOLVING OPERATIONAL ISSUES	322
USING BLUESCALE HARDWARE HEALTH MONITORING	324
Respond to HHM Notifications	324
View Hardware Health Monitoring (HHM) Data	328
CAPTURING TRACES	330
RESETTING THE LIBRARY	333

RESETTING COMPONENTS	333
Reset the LCM or RCM	334
Reset a RIM	335
Reset the Power Control Module	337
TESTING THE ROBOTICS	337
RESTORING THE LIBRARY CONFIGURATION	340
Restore From an Auto Configuration Save File	341
Restore the Library Configuration Using a Saved Configuration ..	346
Restore the MLM and DLM Databases	348

Chapter 13 – Drive Troubleshooting 350

RESETTING A DRIVE	351
USING A GLOBAL SPARE DRIVE	352
Use the Global Spare Drive	353
Undo the Global Spare Drive	356
RETRIEVING A DRIVE TRACE OR DRIVE DUMP FILE	357
Use the Drive Traces Button	357
Use the IBM Tape Diagnostic Tool (ITDT) to Retrieve a Drive Dump ..	359
Use the BlueScale Retrieve Drive Dump Utility	360
TROUBLESHOOTING DRIVES	362
Identify the Problem	362
Interpret the Detailed Drive Information	365
USING DLM TO TEST A DRIVE	379
Requirements for Using the Wizard	379
Run the DLM Drive Health Verification Wizard	381

Chapter 14 – Maintaining the Library 384

UPDATING, SERVICING, OR MOVING THE LIBRARY	385
RENEWING THE BLUESCALE SOFTWARE SUPPORT KEY	386
UPDATING THE BLUESCALE SOFTWARE AND LIBRARY FIRMWARE	388
Check the Library BlueScale Software Version	389
Check Component Firmware Versions (Optional)	390
Check the Currently Released BlueScale Version	392
Download the BlueScale Package	393
Prepare for the BlueScale Package Update	394
Install the Update Package	395
Manage Update Packages	408
INSTALLING CORD LOCKS	409
CALIBRATING THE TOUCH SCREEN	410

Chapter 15 – Maintaining the Drives	411
CLEANING A DRIVE	412
Determine Whether Cleaning is Required	413
Prepare the Library for Drive Cleaning	414
Determine the Cleaning Method	415
Manually Cleaning a Drive	416
Track Cleaning Cartridge Use	418
UPDATING DRIVE FIRMWARE	419
Prepare for the Update Process	420
Update Using ITDT	423
Update Using Drive Update through Package Update	426
Update Using the Drive Firmware Update Wizard	434
Update Using the Update Drive Firmware Utility	437
UPDATING DRIVE DEVICE DRIVERS	441
ADDING OR REPLACING A DRIVE	442
Add a Drive to the Library	442
Replace a Drive	443
Chapter 16 – Technical Support	444
ACCESSING THE TECHNICAL SUPPORT PORTAL	444
Create an Account	445
Log Into the Portal	447
OPENING A SUPPORT TICKET	447
RETURNS	450
Appendix A – Best Practices	451
MLM BEST PRACTICES	451
Implementation Guidelines	452
Usage Policy Guidelines	452
Disaster Recovery Planning	454
BACK UP AND PROTECT THE LIBRARY METADATA	455
Back Up the Library Metadata	455
Verify and Protect the Metadata Backup	457
USING CARTRIDGES	459
Labeling Cartridges	459
Handling Cartridges	460
Storing Cartridges	461
Using Cartridges in the Library	462
Cartridge Rotation	463

Appendix B – Media & Upgrades **466**

MEDIA AND MEDIA ACCESSORIES	466
Spectra Certified Media	466
Media and Media Accessories	467
How To Order	468
LIBRARY SUPPORT AND UPGRADES	468
Service Contract Extension	468
BlueScale Software Updates	469
Library Upgrades	469
How to Order	472
REPLACEABLE COMPONENTS	472

Appendix C – Specifications **473**

LIBRARY SPECIFICATIONS	474
Data Storage Capacity	474
Size and Weight	477
Service Access Requirements	478
Shipping and Storage Size and Weight	478
Power Specifications	479
Environmental Specifications	482
Shock and Vibration Specifications	484
INTEROPERABILITY AND SOFTWARE COMPATIBILITY	484
INTERFACE SPECIFICATIONS	484
Component Interface Connectors	485
Network Interface Cable Requirements	485
Universal Serial Bus (USB) Support	486
NDMP Support	486
TAPE DRIVE AND MEDIA SPECIFICATIONS	486
LTO Tape Drive Specifications	486
TS11xx Technology Tape Drive Specifications	489
Drive-Based Encryption Highlights	490
Tape Media Specifications	490
Barcode Label Specifications	492

Appendix D – Regulatory & Safety Standards **497**

EU DECLARATION OF CONFORMITY	497
EMISSION STANDARDS	498
FCC NOTICE	498

SAFETY STANDARDS AND COMPLIANCE	498
Laser Warning	499
NEMKO ACCREDITATION	499
ENVIRONMENTAL REGULATIONS	500
Waste of Electronic and Electrical Equipment (WEEE) Directive .	500
Restriction of Hazardous Substances in Electrical and Electronic Equipment (RoHS)	500
Measures for the Administration of the Control of Pollution by Electronic Information Products (China)	501
Recycling Your Library	501
CONFLICT MINERALS POLICY	502

Index**503**

ABOUT THIS GUIDE

This guide describes how to configure, use, maintain, and troubleshoot the Spectra® T950V library.

INTENDED AUDIENCE

This guide is intended for data center administrators and operators who maintain and operate backup systems. The information in this guide assumes a familiarity with SCSI and Fibre Channel command protocols, as well as with network connectivity protocols such as Fibre Channel and Ethernet. It also assumes a knowledge of technical tasks such as configuring operating systems and installing drivers.

PRODUCT STATUS

The Spectra Logic® Technical Support portal provides information about which products are currently supported and which are considered discontinued. To view information about discontinued products, log into the portal (see [Accessing the Technical Support Portal on page 445](#)) and navigate to **Documentation** ❖ **Product Discontinuance Information**.

RELATED INFORMATION

This section contains information about this document and other documents related to the T950V library.

BlueScale User Interface Screens

The BlueScale® interface changes as new features are added or other modifications are made between software revisions. Therefore, the screens on your library may differ from those shown in this document.

Additional Publications

For additional information about the Spectra T950V library and its drives, refer to the publications listed in this section.

Spectra T950V Library

This guide and the following documents related to the T950V library are available as PDF files on the Spectra Logic website at: support.spectralogic.com/documentation.

- The *Spectra T950V Library Quick Reference Guide* provides a quick reference for the user interface and instructions for performing day-to-day library operations such as powering on and off, and preparing, importing, and exporting media.
- The *Spectra T950V Library BlueScale Toolbar Option Map* provides a quick reference for locating the options and commands available through the BlueScale user interface.
- The *Spectra T950V Library Site Preparation Guide* provides information about preparing your site for the installation of the T950V library.
- The *Spectra Tape Libraries Encryption User Guide* provides detailed information about using BlueScale Encryption Standard and Professional Edition, the Spectra SKLM Encryption key management system, and the Spectra KMIP Encryption key management. It also provides useful information about encryption best practices and recycling encrypted media.
- The *Spectra Tape Libraries SCSI Developer's Guide* provides detailed information about the SCSI and Fibre Channel commands used in the library.
- The *Spectra Tape Libraries XML Command Reference* provides detailed information about using the XML interface with the T950V library.
- The *Spectra Tape Libraries Warnings* document provides all of the warnings found in Spectra tape libraries documentation, in English and 27 other languages.

The following document is available after logging into your Support portal account at: support.spectralogic.com.

- The *T950V Library Release Notes and Documentation Updates* provides the most up-to-date information about the T950V library, drives, and media.

LTO Ultrium Tape Drives

The following documents provide information that is applicable to all IBM LTO tape drives.

- *IBM Tape Device Drivers Installation and User's Guide*

Note: This guide also provides information about using the IBM Tape Diagnostic Tool (ITDT) to troubleshoot drive problems.

- *IBM TotalStorage LTO Ultrium Tape Drive: SCSI Reference (LTO-6 and later)*

For drive-specific information, search for the product name (for example, LTO 5) on the documentation page on the IBM website. You can also search the IBM Support Portal at:

<http://www-947.ibm.com/support/entry/portal/Documentation>.

TS11xx Technology Drives

The following documents provide information that is applicable to TS11xx technology drives.

- *IBM System Storage Tape Drive 3592 SCSI Reference*
- *IBM Tape Device Drivers Installation and User's Guide*

Note: This guide also provides information about using the IBM Tape Diagnostic Tool (ITDT) to troubleshoot drive problems.

Spectra SKLM Server

For additional information that can assist you during the installation and configuration of your server, see the following website:

IBM Security Key Lifecycle Manager welcome page.

KMIP

See the documentation specific to your server.

Typographical Conventions

This document uses the following conventions to highlight important information:



WARNING

Read text marked by the “Warning” icon for information you must know to avoid personal injury.



Caution

Read text marked by the “Caution” icon for information you must know to avoid damaging the library, the tape drives, or losing data.



Important

Read text marked by the “Important” icon for information that helps you complete a procedure or avoid extra steps.

Note: Read text marked with “Note” for additional information or suggestions about the current topic.

CHAPTER 1

Library Overview

The Spectra T950V library is a low cost, enterprise-class, highly scalable library. It provides fast, affordable storage that meets the stringent requirements for data integrity, data security, and high reliability in an enterprise environment.

This chapter provides an overview of the T950V library features and components.

Topic	
Library Features	this page
BlueScale Software	page 23
Library Components	page 27
Interior Components	page 30
Main and Drive Expansion Frame Rear Components	page 32
Media Expansion Frames	page 36
Operator Panel and Touch Screen	page 37
TeraPack Access Port (TAP)	page 38
Spectra Library Control Modules (LCM and RCM)	page 39
Exporting Controllers	page 42
Tape Drives	page 44
TeraPack Cartridge Handling	page 46
TeraPack Cartridge Handling	page 46
Library Expansion and Upgrades	page 47
The modular design makes it possible to increase media storage capacity or number of drives in the library to meet storage and performance needs as they evolve within an organization. Additional expansion frames can be added to the basic single-frame T950V library to increase the tape slot and drive capacities. See Drive and Media Frames on page 54 for more information.	page 47

LIBRARY FEATURES

This section provides an overview of the features that make the T950V library a highly versatile enterprise storage solution. The library's unique modular design lets you tailor the library to suit your current data requirements and easily expand it in the future. Keep up with data growth and technology changes by adding storage capacity and incorporating new drive technologies as they become available.

BlueScale Software

The library's BlueScale software lets you set configuration options, view library and drive information and metrics, manage cartridges, and monitor library operations. You can access the BlueScale interface using either of the following methods:

- The BlueScale operator panel interface — via the touch screen on the library's operator panel.
- The BlueScale web interface — via the Remote Library Controller (RLC) using a standard web browser.

See [Chapter 3 – Introducing the BlueScale User Interface](#), beginning on [page 70](#), for detailed information about the features and controls provided by the BlueScale user interface.



Important

Many of the features described in this user guide require your library to be running the most current version of the BlueScale software. Spectra Logic recommends that you keep your library's BlueScale software and component firmware up-to-date at all times. If you are using a previously released BlueScale package, upgrading to the current release is strongly recommended. See [Updating the BlueScale Software and Library Firmware on page 388](#) for detailed information.

The BlueScale software includes the following features (listed in alphabetical order).

Auto Configuration Save

The Auto Configuration Save feature automatically generates a weekly backup file and replaces the previous backup file on the memory card in the LCM. The backup file contains the library configuration and the MLM and DLM databases, as well as the encryption configuration and any BlueScale encryption keys. A backup file is also automatically generated and saved whenever a partition is created or modified. See [Use Automatic Backup of the Library Configuration on page 136](#) for more information.

If desired, the library can email the automatically generated backup file each time it is created. Having an external copy of the backup file is highly recommended as it ensures that you can recover the library configuration, as well as the MLM and DLM databases, in the event of a disaster.

Auto Drive Clean

Auto Drive Clean provides library-based cleaning of drives without user intervention. Automated drive cleaning results in fewer failed tape read/write operations and is the recommended method for cleaning drives.

The Auto Drive Clean feature uses a dedicated cleaning partition for storing cleaning cartridges. The cleaning partition can be shared by multiple storage partitions and is used by the library to automatically clean drives whenever necessary. See [Cleaning Partitions and Auto Drive Clean on page 53](#).

AutoSupport

AutoSupport configures the library to automatically contact configured users with messages when specific events occur. It can also be used to open or update a support ticket and send it to a specified email recipient or to Spectra Logic Technical Support. See [Chapter 11 – Configuring and Using AutoSupport](#), beginning on [page 297](#) for detailed information.

Controller Failover (RIMs)

Controller failover configures two Robotics Interface Modules (RIM2s) as a failover pair. One member of the pair (the primary controller) provides the robotic control path in the partition. The other controller (the secondary) is designated as the spare. In the event that the secondary controller detects an internal problem with the primary controller, it automatically takes over all robotics control operations to provide uninterrupted operation. See [Controller Failover on page 66](#) for more information.

Note: Drives used to provide the robotic control path cannot be configured with controller failover; however, you can select multiple drives as controllers, and export the same changer interface over the drives to provide redundancy, as long as your software can support this.

Diagnostics and Utilities

Diagnostics and utilities are available through the BlueScale interface. Selecting a diagnostic or utility displays additional information, including whether or not it can be run while the library is operating.



Important

In general, the library diagnostics and advanced utilities are only for use under the direction of Spectra Logic Technical Support.

Drive Lifecycle Management

BlueScale Drive Lifecycle Management (DLM) helps you identify drives that are experiencing high error rates or other problems. DLM is automatically enabled when Media Lifecycle Management (MLM) is enabled. See [Chapter 10 – Using Drive Lifecycle Management](#), beginning on [page 288](#) for detailed information.

Encryption Key Management

The Spectra T950V library can encrypt data and manage encryption keys, using BlueScale key management, the Spectra SKLM key management system, or KMIP encryption key management.

Spectra SKLM and KMIP encryption run on a stand alone server and provide centralized encryption key management. BlueScale encryption key management is tightly integrated into the BlueScale environment. Encryption is performed through encryption-enabled drives. See the *Spectra Tape Libraries Encryption User Guide* for detailed information.

EnergyAudit Reporting

The BlueScale EnergyAudit feature lets you display actual power consumption. See [View Power Consumption Statistics on page 151](#) for information.

EtherLib

The BlueScale EtherLib feature reduces the time for some library tasks in multi-frame libraries. After installing Ethernet cables, and a switch, if necessary, tasks such as firmware updates and trace gathering complete much faster.

Global Spare

The Global Spare feature provides a way to remotely replace a failed drive in the library. You simply configure an installed drive as a designated spare for other drives in the library. This drive can then be substituted for a failed drive in any partition that is configured to use the Global Spare drive. When a drive fails, you simply log into the BlueScale web interface from any location, select the Global Spare option for the failed drive, and continue normal operations. You can then physically replace the failed drive at your convenience. See [Assign Global Spare Drives on page 173](#) and [Using a Global Spare Drive on page 352](#) for more information.

Hardware Health Monitoring

BlueScale Hardware Health Monitoring (HHM) tracks maintenance thresholds for key robotic components and notifies you when a maintenance threshold is reached. You can click the maintenance icon on the status bar to send the AutoSupport Log (ASL) file to Spectra Logic Technical Support so they can review the log file and determine if any maintenance tasks are needed. See [Using BlueScale Hardware Health Monitoring on page 324](#) for more information.

Media Lifecycle Management

BlueScale Media Lifecycle Management (MLM) helps you manage your tape media by giving you tools to proactively determine potential media errors before they happen. See [Chapter 6 – Configuring and Managing Partitions](#), beginning on page 159 and [Chapter 9 – Configuring and Using Media Lifecycle Management](#), beginning on page 243 for detailed information about configuring and using the MLM features.

Remote Support

The remote support feature uses a remote web access application, WebEx™, to facilitate remote problem diagnosis. Remote support preserves your organization's site and data security, giving Spectra Logic Technical Support limited access to your library. With WebEx, Technical Support can “drive” the library, taking enough control to gather the data required to speed understanding of the problem. See [Remote Support Icon on page 80](#) for more information.

Shared Library Services (SLS) Partitioning

The library uses Shared Library Services (SLS) virtualization technology to partition the library into virtual libraries. SLS partitioning is an option you can add to the library by purchasing an activation key from Spectra Logic. See [Library Partitions on page 50](#) for detailed information about how partitions function in the library. See [Chapter 6 – Configuring and Managing Partitions](#), beginning on page 159 for detailed information about configuring and using partitions.

Soft Power Control

The Soft Power option disables the front panel power button and instead enables a “soft power” button on the General Status screen of the BlueScale user interface. Enabling the Soft Power option prevents unauthorized users from powering the library off using the front panel power switch. See [Use the Soft Power Feature on page 143](#) for more information.

Thin Provisioning

The Thin Provisioning option allows automatic library partition resizing as a partition requires greater slot count, without reconfiguring the library or host software. Using Thin Provisioning, it is possible for the combined number of storage slots configured in all library partitions to exceed the licensed or physically available number of slots. Empty slots are included in, but inaccessible to, all partitions until you import a TeraPack magazine into one partition. At that time, the library makes the slots accessible to only the partition into which the magazine was imported. You can import additional magazines into any of the thin provisioned partitions until the inventory reaches the licensed or physical capacity.

XML Command Interface

The XML command interface provides a set of commands for use in customer-generated programs used for viewing the library's status, inventory, and configuration information, and performing BlueScale package updates and other operations without using the BlueScale user interface. See the *Spectra Tape Libraries XML Command Reference* for detailed information.

Library Components

The following sections show the locations of and briefly describe the major front panel, internal, and rear panel components of the library's main, drive expansion, and media expansion frames.

Front Panel Components

Figure 1 shows the front components of a multi-frame T950V library. The figures also show the relative locations of the main frame and the expansion frames.

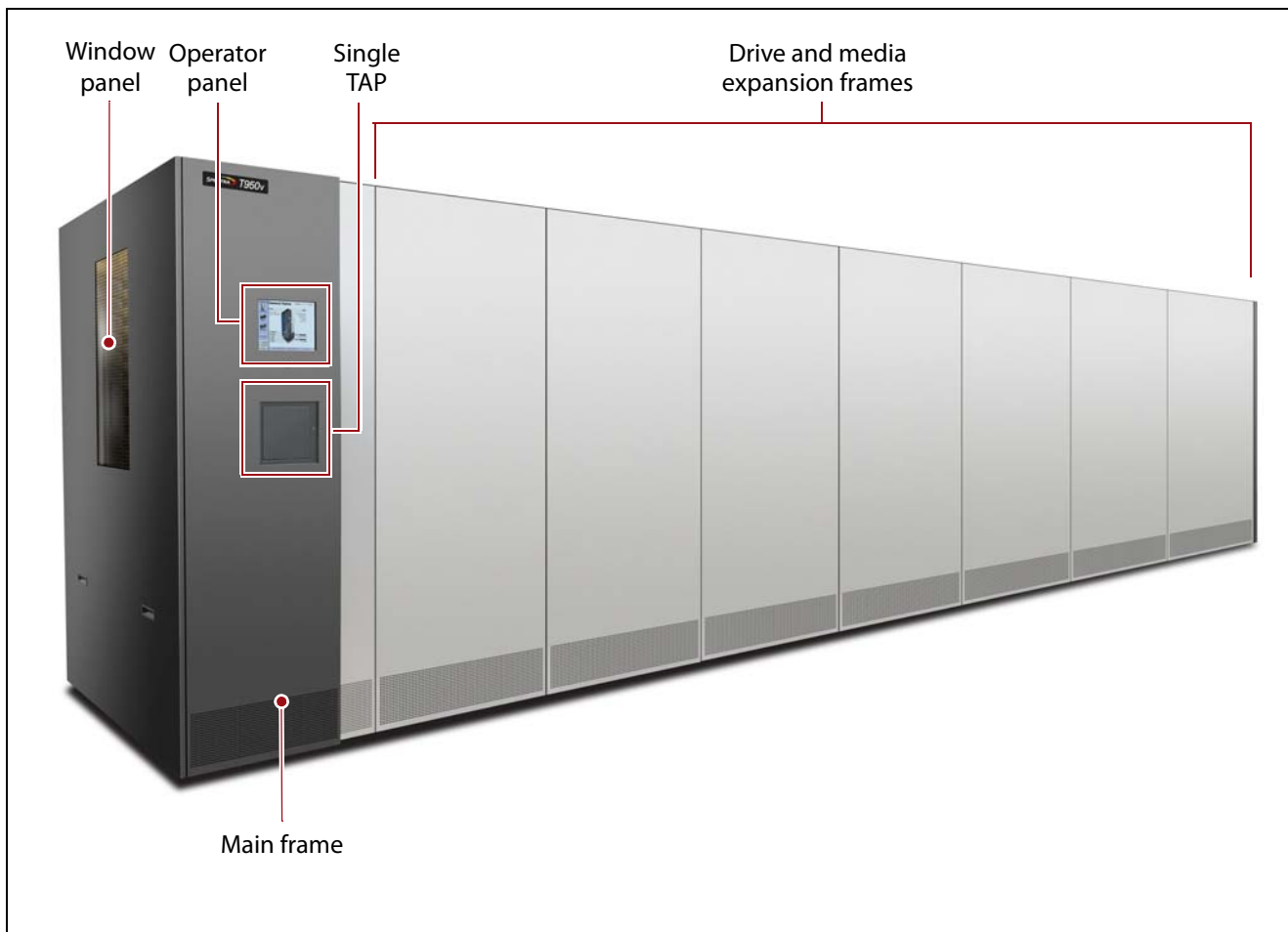

Figure 1 Eight-frame T950V library.

The following table describes each of the components shown in [Figure 1 on page 28](#).

Component	Description
Window Panels	The window panels on the outer side of the right- and left-most frames let you view the inside of the library and provide access to the interior components. The window panels are equipped with safety interlocks that power down the library robotics when removed.
Main Frame	The main frame houses the library control module (LCM), the main robotics control module (RCM), the operator panel, the TeraPack Access Port (TAP), controllers (RIM2s), power supplies, the EtherLib switch (optional), and drives. It also provides cartridge storage.
Operator Panel	The operator panel on the main frame includes a color LCD touch screen and library power button. To learn more, see Operator Panel and Touch Screen on page 37 . A stylus for making selections and typing entries on the touch screen is conveniently stored near the screen.
TeraPack Access Port (TAP)	The TeraPack Access Port (TAP) acts as entry/exit ports that lets you import media into or remove media from the library. To learn more about the TAP, see TeraPack Access Port (TAP) on page 38 .
Expansion Frames	Expansion frames make it possible to increase media storage capacity or the number of drives in the library. See Drive and Media Frames on page 54 for more information.

Interior Components

Figure 2 shows the interior components of the library.

Note: The interior components are shown for reference only. They are not accessible during normal operation.

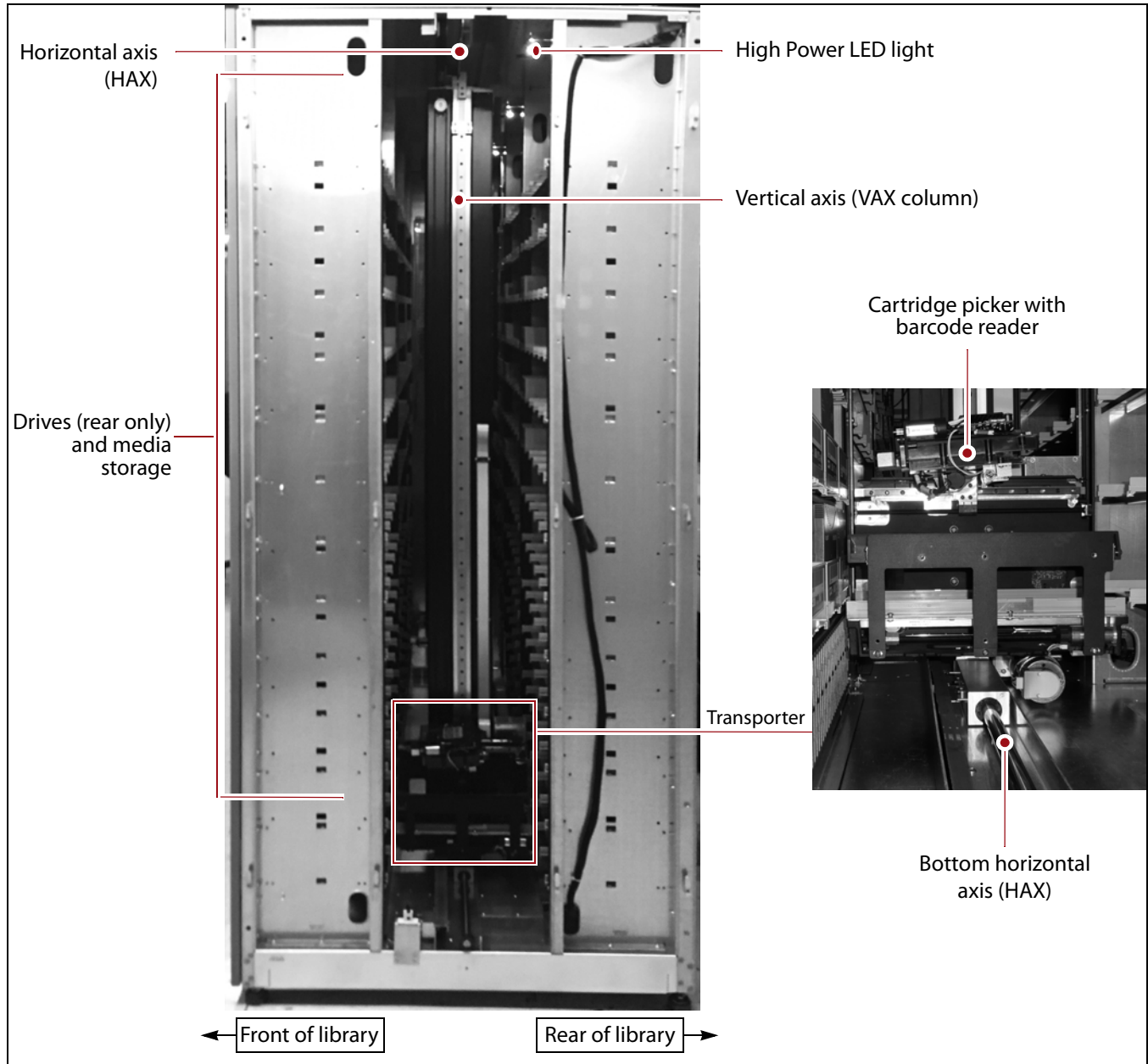

Figure 2 Library interior components.

The following table describes each of the components shown in [Figure 2 on page 30](#).

Component	Description
High Power LED Light	A single high power LED light illuminates the interior of each frame.
Transporter	<p>The transporter and the Vertical Axis (VAX) column make up the robotics used to move a TeraPack magazine from one location to another in the library. The transporter, which is mounted on the VAX column, retrieves the magazine from the source chamber and holds it while the VAX column moves to its destination. The cartridge picker then removes the requested individual cartridge from the magazine and inserts it into a drive. When the drive is finished using the cartridge and ejects it, the cartridge picker retrieves the cartridge and places it in a magazine. The VAX column then moves the transporter to return the magazine to a storage chamber.</p> <p>The VAX column moves along the horizontal axis (HAX) and the transporter moves up and down the VAX column to perform all media movement within the library. The barcode reader mounted on the cartridge picker reads the barcode labels on TeraPack magazines and individual cartridges. The library uses the barcode label information to maintain an inventory of the media currently stored inside the library.</p>
Media Storage	<p>All of the media in the library is stored in TeraPack magazines, each of which contains ten slots for LTO media or nine slots for TS11xx technology media. The magazines are placed on shelves, which are divided into chambers. Each chamber provides storage for one TeraPack magazine.</p> <p>The number of slots in a frame depends on the type and configuration of the frame (see Drive and Media Frames on page 54). All frames have media storage chambers at both the front and the rear of the frame. The maximum media storage capacity of the library depends on the type of media, the number of drives installed, and the number of drive and media expansion frames installed (see Data Storage Capacity on page 475).</p>

Main and Drive Expansion Frame Rear Components

The components on the library's rear panel depend on the type of frame. [Figure 3](#) shows the rear panel components of the library's main frame. Except where noted in the following descriptions, the same components are present in each drive expansion frame.

Note: Any bays that do not contain components must have covers installed to maintain proper air circulation throughout the library and to protect the internal components.

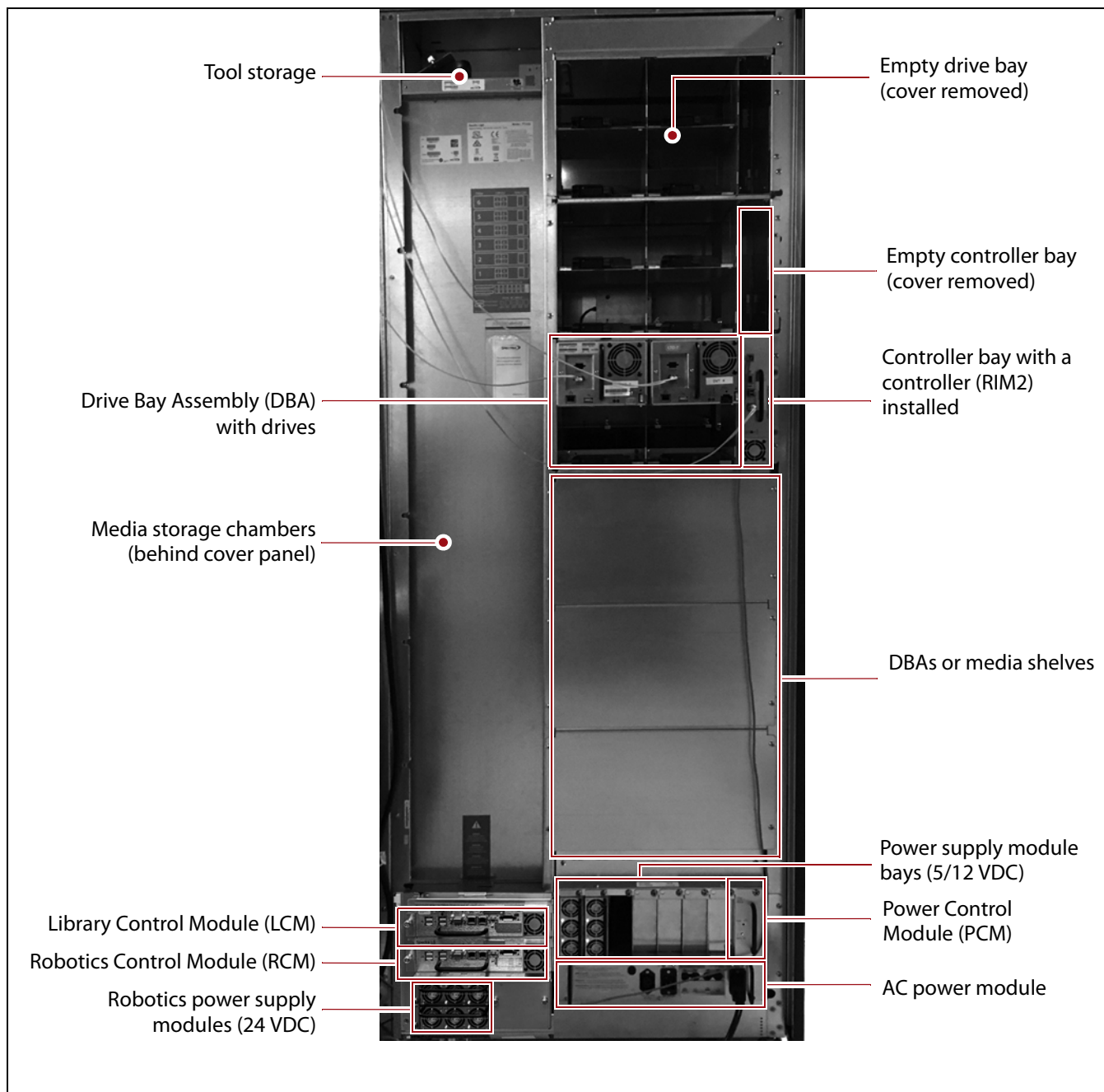
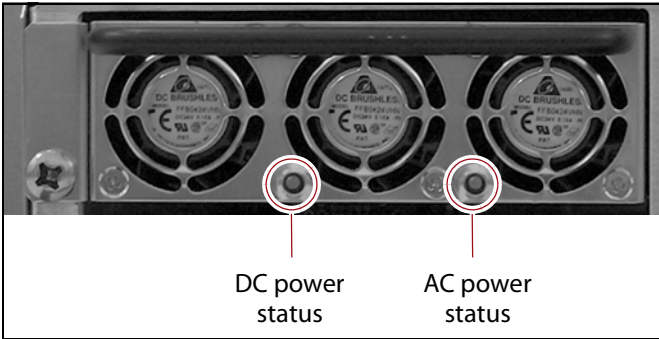
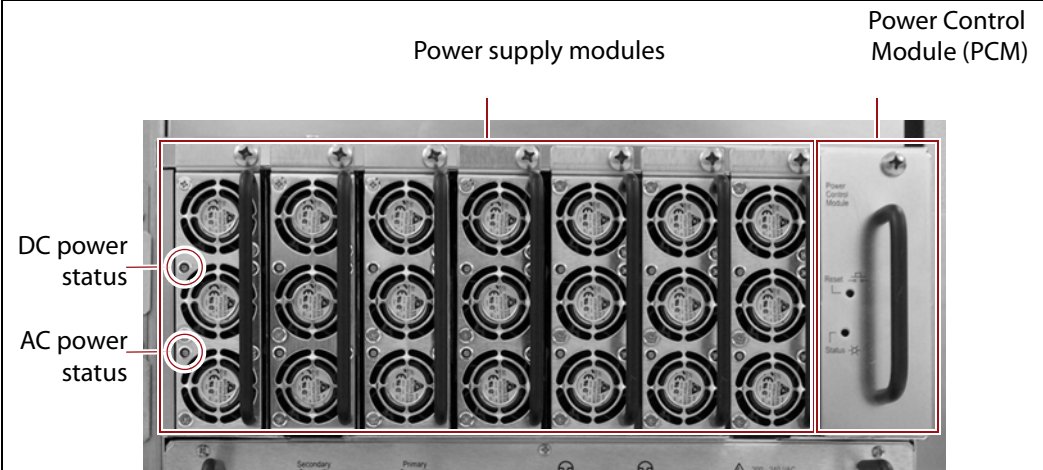

Figure 3 Library rear components (main frame).

The following table describes each of the components shown in [Figure 3](#) on [page 32](#).

Component	Description
Tool Storage	The compartment above the media storage area in the main frame provides space for storing the tool kit and documentation that accompanies the library.
Media Storage Chambers	All of the media in the library is stored in TeraPack magazines, each of which contains ten slots for LTO media or nine slots for TS11xx technology media. The magazines are placed on shelves divided into chambers. The number of chambers at the back of a frame depends on the type of frame and its configuration (see Drive and Media Frames on page 54).
Drive Bay Assemblies (DBAs)	<p>Each DBA provides the electrical and internal interface connections for up to four full-height drives. See Tape Drives on page 44 for information about the drives used in the library. Each DBA also includes a controller bay for a RIM2 or EtherLib switch to the right of the drives.</p> <p>The T950V main frame can have one, three, or six DBAs installed. Drive expansion frames can have three or six DBAs installed. Shelves for media storage are installed in the remaining space where DBAs could be installed.</p> <p>Note: Any drive or controller bays that do not contain components must have covers installed to maintain proper air circulation throughout the library and to protect internal components.</p>
LCM and RCM	<p>Dedicated on-board library control modules run the BlueScale software that controls all aspects of library operation. Depending on where the module is installed, it functions as the Library Control Module (LCM) or the Robotics Control Module (RCM). To learn more, see Spectra Library Control Modules (LCM and RCM) on page 39.</p> <p>Note: Drive expansion frames only have an RCM, they do not include an LCM. A cover over the opening maintains proper air circulation throughout the frame.</p>

Component	Description
<p>24 VDC Robotics Power Supply Modules</p>	<p>Two 24 VDC power supply modules in the main frame provide redundant power for the library robotics and motors.</p>  <p>Figure 4 The 24 VDC power supply LEDs.</p> <p>Each 24 VDC power supply module has two indicator LEDs, one for DC power status and one for AC power status. The color of the LED indicates the power supply status:</p> <ul style="list-style-type: none"> ▪ Green — The power is on and functioning normally. ▪ Orange — The power supply has a fault condition. ▪ Off — The power is not on or the power supply module is not functioning normally. <p>Notes:</p> <ul style="list-style-type: none"> ▪ Drive expansion frames do not include 24 VDC power supply modules. ▪ If the second 24 VDC power supply module is not installed, a cover over the opening maintains proper air circulation throughout the frame.
<p>RIM2</p>	<p>One RIM2 can be installed in each of the vertical controller bays to the right of the drives in a DBA (see Figure 3 on page 32). A RIM2 or an LTO tape drive can be used to provide the robotic control path for the library. To learn more, see Exporting Controllers on page 42.</p>
<p>Drives</p>	<p>The library accommodates multiple generations of high-performance, high-capacity, full-height and half-height LTO drives or TS11xx technology drives. The drives are installed in DBAs, with each DBA accommodating up to four drives. Drives are hot-swappable to provide uninterrupted operation. To learn more, see Tape Drives on page 44.</p> <p>Note: Any drive bays that do not have drives installed must have covers installed to maintain proper air circulation throughout the frame and to protect internal library components.</p>

Component	Description
<p>5/12 VDC Power Supply Modules</p>	<p>The 5/12 VDC power supply modules convert AC input to provide the 5 VDC and 12 VDC power used by the drives in the frame. In the main frame, these power supplies also provide power to the controller bays, the LCM, the RCM, and the LCD operator panel. With the exception of its voltage rating, the 5/12 VDC power supply module closely resembles the 24 VDC robotics power supply module shown on page 34.</p> <p>A minimum of one power supply per populated DBA is required. Installing an optional N+1 power supply, where N is the number of DBAs with one or more installed drives, provides redundancy and failover protection in the event that a single power supply fails. See Redundant Power Supplies on page 69 for additional information.</p> <p>Each power supply module has two indicator LEDs, one for AC power status and one for DC power status. The color of the LED indicates the status.</p> <ul style="list-style-type: none"> ▪ Green — The power is on and functioning normally. ▪ Orange — The power supply has a fault condition. ▪ Off — The power is not on or the power supply module is not functioning normally. <p>Note: Any bays that do not have power supply modules installed must have covers installed to maintain proper air circulation throughout the frame.</p> <div data-bbox="435 932 1472 1398" style="border: 1px solid black; padding: 5px;">  </div> <p>Figure 5 The 5/12 VDC power supply modules and the PCM.</p>
<p>Power Control Module (PCM)</p>	<p>The PCM supplies power to the power supplies when you press the power button on the front panel of the main frame. It monitors the power supply modules in the frame for output voltage, output current, power supply fan operational status, and power supply operational temperature. The PCM uses the voltage and current data to calculate the library power usage that is displayed through the BlueScale user interface.</p>

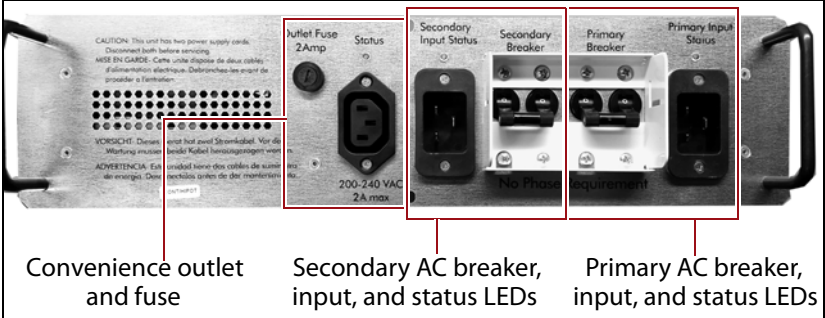
Component	Description
<p>Dual AC 2 Power Module</p>	<p>The dual AC 2 power module provides surge protection for the library power system and monitors the primary AC input power to determine whether it is present and of adequate voltage. If the primary AC input fails or drops too low, the dual AC 2 power module handles the failover to the redundant, secondary AC input until the primary input is restored.</p> <p>Each dual AC 2 power module includes both primary and secondary AC power connectors, two breaker switches, and a convenience outlet rated at 2 amps.</p> <p>LEDs indicate the status of the primary and secondary AC inputs and the overall dual AC 2 module.</p> <ul style="list-style-type: none"> ▪ Primary and Secondary Input Power LED States: <ul style="list-style-type: none"> ▪ Green - Good/Active ▪ Blue - Good/Not Active ▪ Orange - Bad/Active, cannot switch to secondary source ▪ Red - Under Voltage Lockout ▪ Off - Not Present ▪ Dual AC 2 Status LED States: <ul style="list-style-type: none"> ▪ Blinking Green - Good Status ▪ Solid Red - Over Temperature, > 100° C <p>Note: The convenience outlet is powered by the primary AC input. If the primary input fails, the convenience outlet does not function.</p>  <p>Figure 6 Dual AC 2 power module.</p>

Media Expansion Frames

Media expansion frames are for media storage only and do not include any active front or rear panel components. See [Data Storage Capacity on page 475](#) for more information.

Operator Panel and Touch Screen

The operator panel touch screen on the main frame provides local access to the BlueScale user interface through the Library Control (LC) server. You can select options and enter information by touching the appropriate location on the screen. For detailed information about using the BlueScale user interface through the touch screen, see [Chapter 3 – Introducing the BlueScale User Interface](#), beginning on page 70.

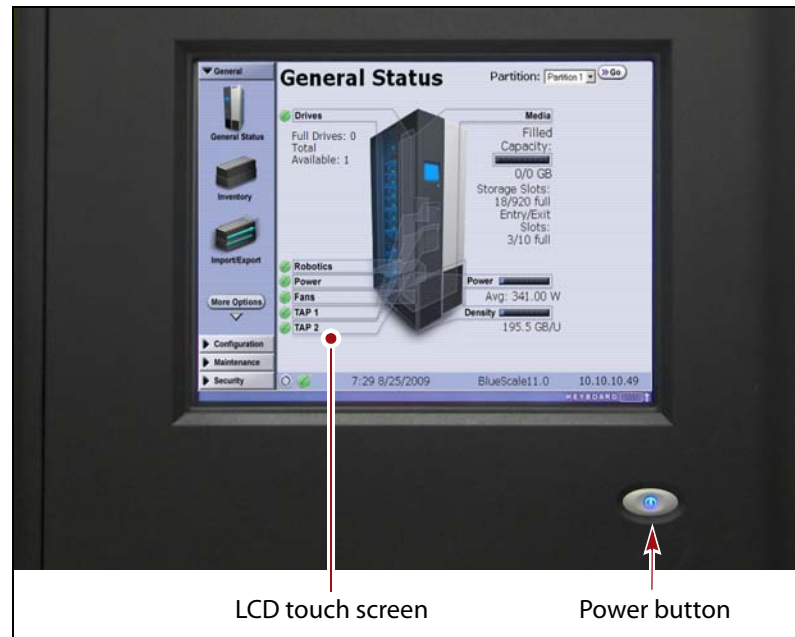

Figure 7 The library operator panel displaying the General Status screen of the BlueScale user interface.

The operator panel includes the following features:

Component	Description
LCD touch screen	The LCD touch screen lets you monitor library operations and select configuration options using the BlueScale user interface.
Power Button	The power button provides front panel on/off control of the library.
Stylus (not shown)	A stylus for making selections and typing entries on the touch screen is conveniently stored near the screen using the included holder.
USB Port	The USB port can be used to connect a USB device to the library for transferring BlueScale encryption keys, saving configurations, and uploading software packages. You can also connect a USB keyboard to the USB port.

TeraPack Access Port (TAP)

The TeraPack Access Port (TAP) acts as an entry/exit port that lets you import magazines into or export magazines from the library. A magazine can contain one or more cartridges or it can be empty. During import or export operations, the TAP door opens so that you can insert or remove a magazine.

- Notes:**
- To import or export individual cartridges, they must be placed in a magazine.
 - All import and export requests are issued through the Import/Export screen of the BlueScale front panel user interface or by using the XML command interface.

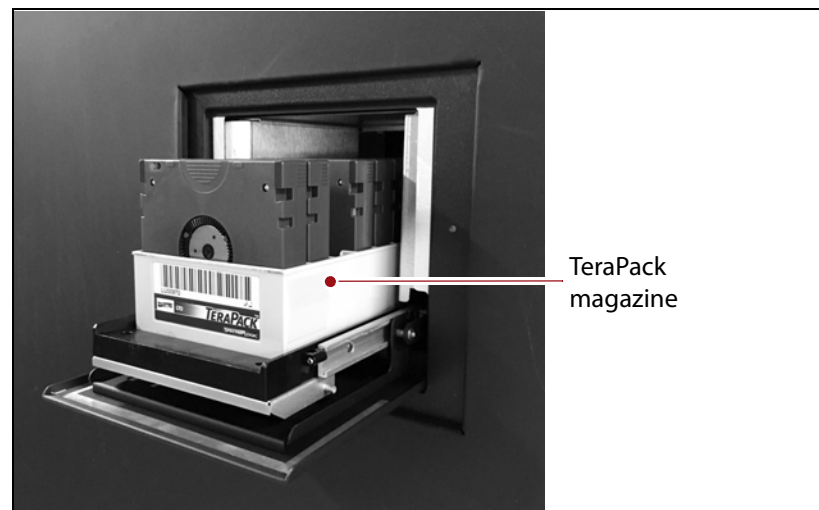

Figure 8 The center TAP with a TeraPack magazine loaded.

Using the TAP to move cartridges into and out of the library provides these key advantages:

- **Data Security** — Media is never stored in the TAP. A newly inserted TeraPack magazine is automatically moved into the library and placed in a storage chamber. A magazine already in the library is only moved to the TAP when you request an export operation through the user interface. Data security and backup integrity are enhanced because the media stored in the library can only be accessed using the password-protected BlueScale user interface or XML interface.
- **Convenience** — Instead of individually importing or exporting single cartridges as you would with a traditional entry/exit port, using a TAP lets you handle multiple cartridges in a single operation, thus reducing the time spent on import and export tasks.

See [Chapter 7 – Importing and Exporting Cartridges](#), beginning on [page 196](#) for details on using the TAP to import and export TeraPack magazines.

Spectra Library Control Modules (LCM and RCM)

The library uses multiple Spectra LS control modules. These dedicated computers run the library's BlueScale software, which controls and manages all aspects of the library operation. Depending on where the module is installed in the library, it functions as either the Library Control Module (LCM) or the Robotics Control Module (RCM).

- Notes:**
- The main frame has both an LCM and an RCM; drive expansion frames only have an RCM.
 - The LCM and the RCM in the main frame do not provide failover redundancy for each other in the event that one of the modules fails.
 - Media expansion frames do not contain any library control modules.

Spectra LS Components

shows the external components on the Spectra LS.

Note: When the control module is functioning as an RCM, the connectors are only used for troubleshooting and diagnostic purposes under the direction of Spectra Logic Technical Support.

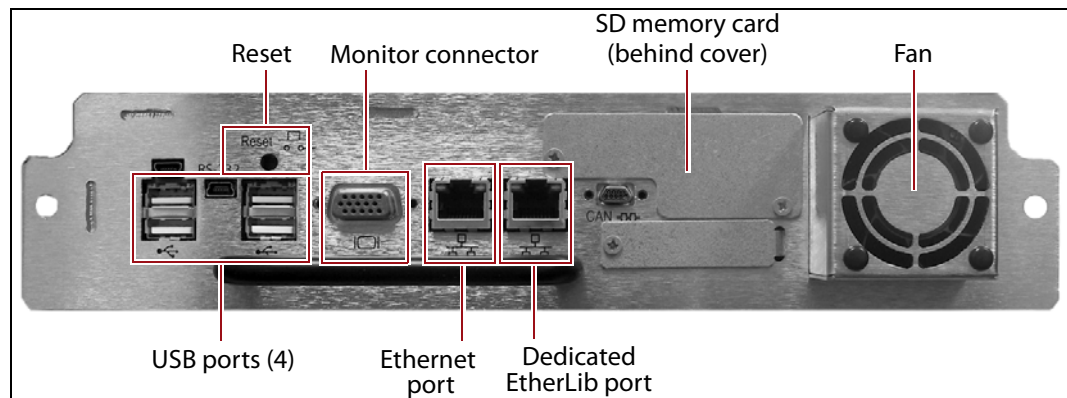

Figure 9 The connectors and components on the Spectra LS.

The following table describes the components shown in [Figure 9](#).

Component	Description
USB Ports	<p>The USB ports on the LCM can be used to connect a USB device for transferring BlueScale encryption keys, saving configurations, and uploading BlueScale packages. You can also connect a USB keyboard and mouse to the USB ports on the LCM and use them when interacting with the BlueScale user interface. This connection provides access to all of the options available from the library's front panel touch screen.</p> <p>Note: Use the USB port(s) on the RCM to update the firmware on the RCM during BlueScale package update or under the direction of Technical Support for capturing motion traces that are used for troubleshooting.</p>

Component	Description
Monitor Connector	<p>You can connect a monitor to the LCM and use it to view the BlueScale user interface instead of using the library's front panel.</p> <p>Note: The monitor connector on an RCM is only used by service personnel.</p>
Ethernet Port	<p>The Ethernet port on the LCM connects the library to an Ethernet network and is used to access the library through the BlueScale web interface using the Remote Library Controller (RLC). The BlueScale web interface provides access to all of the options available from the library's operator panel except those that require physical interaction with the library (for example, importing or exporting media).</p> <p>Notes:</p> <ul style="list-style-type: none"> ▪ When the module is functioning as the RCM, the left-most Ethernet port is only used for troubleshooting by service personnel. ▪ The Spectra LS has a 10/100/1000BaseT connection.
Dedicated EtherLib Port	<p>The right-most Ethernet port on the Spectra LS is configured as a dedicated EtherLib port. EtherLib uses this dedicated port to speed communication between components in the library.</p> <p>Note: This port cannot be used to access the library through the BlueScale web interface.</p>
Memory Card (behind cover)	<p>The Secure Digital (SD) memory card in each module stores information related to its functional role in the library. When the library control module is installed in the library and powered on for the first time, the library determines the location and then activates either the LCM or RCM code on the memory card. Once this is done, the module performs only the functions defined by the activated code on the memory card. In addition to the code that determines the module's role in the library, the memory card is used to store the following:</p> <ul style="list-style-type: none"> ▪ In the LCM, it stores the library's configuration information, activation keys, system settings, and partition settings. It also stores the MLM and DLM databases and information related to the current system status. ▪ In the RCM, it stores the library's configuration information, system logs, and inventory. <p>Notes:</p> <ul style="list-style-type: none"> ▪ Two extra memory cards come standard with new libraries for error recovery. ▪ Before replacing a memory card, it is important to backup the information it contains, if possible. See the <i>Spectra T950 or TFinity Memory Card Replacement</i> guide for more information.
RS-232 and CAN Connectors	<p>These connectors are only used for troubleshooting by service personnel.</p>

LCM and RCM Functionality

The functionality provided by the control module is determined by where the module is installed and the information on the memory card installed in the module.

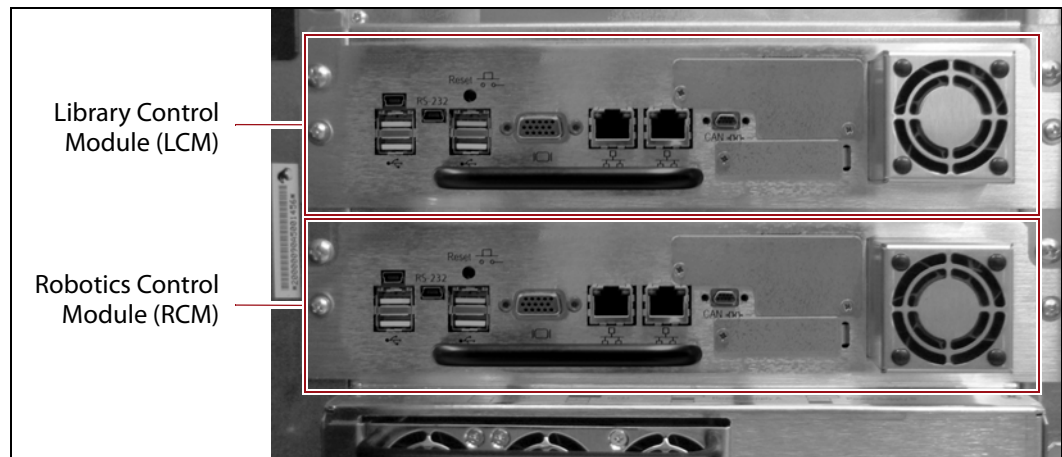

Figure 10 Identifying the LCM and the RCM.

- When installed in the top bay of the main frame, the module functions as the Library Control Module (LCM).
 - Note:** Drive expansion frames do not have an LCM. A cover over the opening where the LCM would be installed maintains proper air circulation throughout the frame.
- When installed in the bottom bay of the main frame or in a drive expansion frame, the module functions as the Robotics Control Module (RCM).

The following table describes the functions of each control module:

Control Module	Function
Library Control Module (LCM)	<p>Runs the BlueScale software, which provides the BlueScale user interface that is used to perform all configuration, import/export, and management functions for the library. The BlueScale user interface is accessed locally through the library's touch screen. In addition, an embedded web server provides remote access to the BlueScale web interface and to the XML command interface using a standard web browser.</p> <p>In addition to providing the user interface, the BlueScale software running on the LCM generates and maintains the MLM database, BlueScale encryption keys, system logs, and other information related to the current system status. It also handles email operations such as sending a backup file and AutoSupport logs to preconfigured recipients.</p>
Robotics Control Module (RCM)	<p>Processes media changer commands from the hosts and storage management software to control the operation of the robotics. The RCM also stores all of the information relating to the location and status of each element in the library, as well as the raw media inventory in its non-volatile memory. This functionality allows the library to continue performing backup/restore operations, even when the user interface provided through the LCM is unavailable.</p>

Exporting Controllers

Either a direct-attached LTO drive or a RIM2 is required to provide the control path for the library's robotics. When configuring a storage partition, the device you select to provide the robotic control path is referred to as the "exporting controller" for the partition.

The controller is the bridge between an external Fibre Channel or SAS connection from the host and the internal interface used by the library. It provides the control path for the media changer commands sent from the host to the library. The controller relays the commands to the RCM, which processes the commands and uses them to control the robotics in the library.

A minimum of one controller is required to connect the library's robotics to the host network. To learn more about the role the controller plays in the library, see [Robotic Controller Connectivity on page 59](#).

- Notes:**
- An LTO tape drive can only provide the control path for one partition. A RIM2 can provide the robotic control path for up to 16 partitions.
 - The maximum number of exporting controllers (drives and RIMs) supported by the library is six.
 - A TS11xx technology drive cannot provide the robotic control path. TS11xx technology partitions must use a RIM2.
 - RIM2s can be configured for controller failover.
 - If desired, you can configure multiple exporting controllers (drives or RIM2s) for a partition, and export the same changer interface over the drives to provide redundancy, as long as your backup software can support this. These multiple paths cannot be used at the same time.

RIM2s are mounted in the vertical controller bay located along the right side of each DBA (see [Figure 3 on page 32](#)).

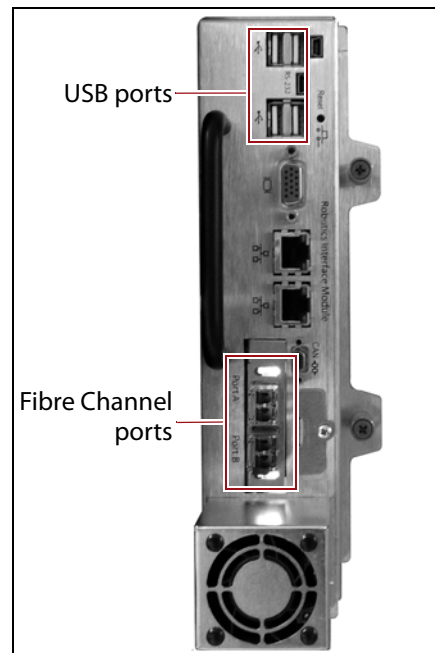

Figure 11 The Robotics Interface Module 2 (RIM2).

The following table describes the controllers supported by the library.

Controller	Description
RIM2	<p>The RIM2 has two dual-channel 8-Gbps Fibre Channel ports (Port A and Port B), which can be used to provide connections to two separate Fibre Channel arbitrated loops or fabrics. The two ports can also be used to provide redundant control paths to the robotics from a single Fibre Channel arbitrated loop or fabric.</p> <p>Controller failover can be configured using a second RIM2.</p> <p>The USB ports (4) can be used to connect a USB device for updating the RIM2 during a library package update.</p> <p>Notes:</p> <ul style="list-style-type: none"> ▪ The Ethernet ports on the RIM2 are reserved for future use. ▪ The CAN port, RS-232 port, and monitor port on the RIM2 are for troubleshooting only.
LTO Tape Drive	<p>The commands to control the motion of the robotics within the partition are sent from the host to the exporting drive's logical unit number 1 (LUN 1). The motion control commands are then routed to the robotics using the exporting drive's Automation/Drive Interface (ADI).</p>

Tape Drives

The T950V supports LTO-6 and later generation Fibre Channel full-height drives, LTO-7 and LTO-8 half-height Fibre Channel and SAS drives in full-height drives sleds, and TS1150 technology and higher, TS11xx technology drives. The drives are mounted in drive sleds, which are installed in DBAs in the main and drive expansion frames. Each DBA can accommodate up to four drives. Drives are hot-swappable to provide uninterrupted operation.

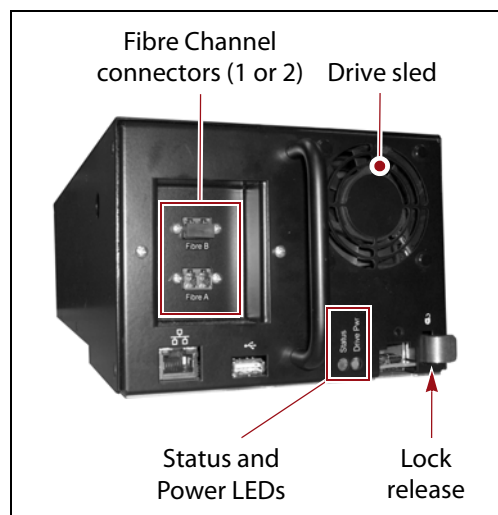

Figure 12 The LTO Fibre Channel drive sled.

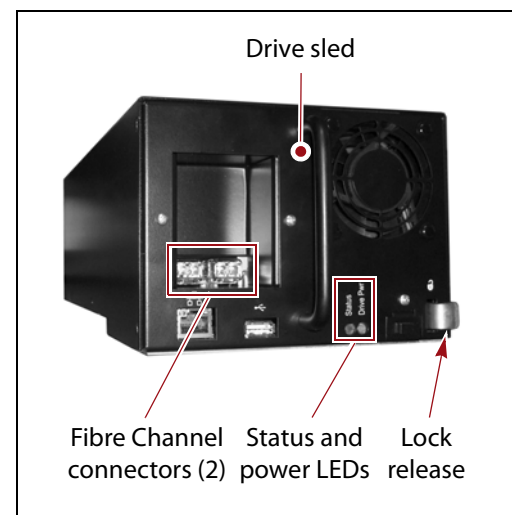

Figure 13 The TS11xx technology drive sled.

The following table describes the drive components.

Component	Description
Drive Sled	<p>The drive sled provides the electrical and logical connections to the library, as well as the connections to the host Fibre Channel arbitrated loop or fabric. The drive sled firmware assigns an identifier to the drive based on its location in the library (see Drive Identifiers on page 57). This identifier is used by the library to identify the drives in the BlueScale and XML interfaces. See Drive Connectivity on page 64 for additional information about the Fibre Channel connectivity provided by the drive sled.</p>
Fibre Channel Connectors	<p>Each Fibre Channel drive sled has two multi-mode optical SFP LC connectors (Port A and Port B) that are used to connect the drive directly to a Fibre Channel network. The two ports let you connect two separate fiber optic cables to each drive.</p> <p>Note: For half-height drives in a full-height sled, only port A is available.</p>
SAS Connector	<p>Each SAS drive sled has a single, unshielded, SFF-8088 serial port that provides the Serial Attached SCSI (SAS) connectivity for the drive.</p>
Status LED	<p>Indicates the operational status of the drive sled (not the drive).</p> <ul style="list-style-type: none"> ▪ Flashing green — The drive sled is functioning normally. ▪ Flashing red/orange — The drive sled experienced an error. ▪ Alternating flashing green and red/orange — The drive is ready for replacement (see Replace a Drive on page 444).
Drive Power LED	<p>Indicates whether the drive is powered on.</p>
Lock Release	<p>The drive sled automatically locks into place when it is installed in the DBA to keep it from being accidentally pulled out of the library. The lock release disengages the lock.</p>
Ethernet and USB Ports	<p>These ports are typically unused, however, they may be used by service personnel to perform drive firmware updates.</p>

For more information about the drives in the library, see:

- [LTO Ultrium Tape Drives on page 20](#) for a list of documents that provide information that is applicable to all IBM LTO tape drives.
- [TS11xx Technology Drives on page 20](#) for a list of documents that provide information that is applicable to TS11xx technology drives.
- [Creating a Storage Partition on page 169](#) for information about creating storage partitions that use the drives.
- [LTO Tape Drive Specifications on page 487](#) for information about the transfer rates and storage capacities of LTO drives.
- [TS11xx Technology Tape Drive Specifications on page 490](#) for information about the transfer rates and storage capacities of TS11xx technology drives.
- [Component Interface Connectors on page 486](#) for cabling requirements for host connections to the drives.

TERAPACK CARTRIDGE HANDLING

The library optimizes space usage by storing media on horizontal shelves. This horizontal storage provides very high density by using space within the library instead of the limited space provided by the vertical library walls. Each horizontal shelf is divided into multiple equal-sized media storage chambers. Each chamber accommodates a single TeraPack magazine.

The library uses TeraPack magazines to import and export cartridges through the TAPs and to store cartridges inside the library. Each magazine holds up to ten LTO cartridges or nine TS11xx technology cartridges. The magazine has guides along each side and grooves on the bottom to ensure proper alignment when it is inserted into the TAP.



Figure 14 TeraPack magazine with barcode labeled cartridges and plastic dust cover (LTO shown).

Storing and handling cartridges in TeraPack magazines helps eliminate errors resulting from mishandling individual tapes, which is the leading cause of tape damage. When inside the library, TeraPack magazines are stored in semi-enclosed chambers. When not in the library, an optional clear plastic dust cover snaps onto the magazine to protect the cartridges. The cartridges are continually protected by the TeraPack magazine, both inside and outside of the library.

Using TeraPack magazines offers the following advantages:

- **Barcode labeling** All of the cartridges in a TeraPack magazine, as well as the magazine itself, are barcode labeled for easy identification.
- **Grouped media** The cartridges in a TeraPack magazine are treated as a single unit during import and export operations. This grouped media handling simplifies media management tasks by eliminating the need to import or export cartridges one by one.

LIBRARY EXPANSION AND UPGRADES

The T950V library is designed to transform and expand to meet a data center's changing storage requirements, as well as to achieve storage consolidation goals. See [Appendix B – Media & Upgrades](#), beginning on [page 467](#) for additional information.

Capacity on Demand (CoD)

The library's capacity-on-demand feature (CoD) lets you purchase a library that suits your current needs and then purchase additional capacity later as required. CoD reduces up-front costs, because you only pay for what you currently need. As more capacity is required, it can be added in increments by purchasing activation keys to license additional chambers in the library. You can then import additional TeraPack magazines to fill the licensed chambers.

Modular Expansion

The modular design makes it possible to increase media storage capacity or number of drives in the library to meet storage and performance needs as they evolve within an organization. Additional expansion frames can be added to the basic single-frame T950V library to increase the tape slot and drive capacities. See [Drive and Media Frames on page 54](#) for more information.

CHAPTER 2

Architecture Overview

The T950V library is designed to provide maximum flexibility and ease of use in a low-cost enterprise-class system. To take full advantage of the library's versatility, read this overview of the library's software and hardware architecture.

Topic	
Media Pools	page 49
Library Partitions	page 50
Storage Partitions	page 52
Cleaning Partitions and Auto Drive Clean	page 53
Drive and Media Frames	page 54
Component Identifiers	page 55
RIM2 Identifiers	page 57
Drive Identifiers	page 57
Fibre Channel Connectivity	page 58
Robotic Controller Connectivity	page 59
Drive Connectivity	page 64
High-Availability Configurations	page 65
Redundant Connectivity	page 66
Global Spare Drives	page 69
Redundant Power Supplies	page 69

MEDIA POOLS

Inside the library, magazines, and the cartridges they contain, are logically grouped through the use of pools. These pools are made up of chambers, each of which accommodates a single magazine. The library has three different types of pools: the free pool, one or more entry/exit pools, and one or more storage pools. [Figure 15 on page 51](#) shows how the entry/exit and storage pools are related to partitions in the library.

Free pool Chambers that are not assigned to a partition are in the free pool. These chambers can be assigned to a storage partition or a cleaning partition. The chambers in the free pool cannot be accessed through the BlueScale user interface or the storage management software until they are added to a partition.

Entry/Exit pool The chambers in a storage partition's entry/exit pool provide an interim storage location for cartridges during import and export operations. Together, the entry/exit pool and the TAP function as a configurable entry/exit port for the library.

You specify the number of chambers assigned to the entry/exit pool when you create a storage partition. Cleaning partitions do not have an entry/exit pool.

A cartridge is in the entry/exit pool for one of the following reasons:

- It was ejected from the storage pool by the storage management software or moved manually using the BlueScale user interface. To remove the cartridges from a library, the operator uses the library's BlueScale user interface to initiate the export process.
— OR —
- A magazine containing one or more cartridges was imported into the library using the TAP. From the entry/exit pool, the cartridges can be imported into the storage partition's storage pool either by the storage management software or manually through the BlueScale user interface.
— OR —
- A magazine containing one or more special-purpose cartridges was imported into the library using the TAP. These cartridges may be used for cleaning a drive using the DLM Drive Test feature, or for updating drive firmware using a code load tape.

Storage pool The chambers in a storage partition's storage pool provide the cartridge storage for a partition. You specify the number of chambers assigned to the storage pool when you create a partition. See the next section, [Library Partitions](#), for detailed information about how the storage pool is used in partitions.

- Each storage partition has its own storage pool; the pool contains at least one chamber. The cartridges in the storage pool are available for use by the host storage management software that accesses the partition.
- A cleaning partition has at least one chamber in its storage pool and can be shared by multiple storage partitions if they all use the same type of cleaning cartridge. The cleaning cartridges stored in the cleaning partition are only accessible when the library is configured to use the Auto Drive Clean feature. They are not accessible to the storage management software.

LIBRARY PARTITIONS

Partitions divide the library logically so that it appears as one or more physical libraries — one library per configured partition. Partitioning simplifies storage consolidation through the creation of virtual libraries, each with its own drives and media. Each partition:

- Has exclusive access to the tape drives and media storage assigned to it.
- Can control the robotics to move media within the partition.

The library supports two types of partitions, storage partitions and cleaning partitions. You can configure a maximum of 16 partitions using a maximum of six physical controllers. One or more cleaning partitions can be configured in a single library. A single cleaning partition can be associated with multiple storage partitions. Cleaning partitions do not count against the partition maximum.

- Notes:**
- A single RIM2 can export up to 16 partitions.
 - An LTO drive can only export one partition.
 - The more partitions in a library, the longer each move can take. If move requests can be sent to several partitions at once, you may need to increase the timeout setting in your storage management software.

Figure 15 shows a conceptual illustration of a library configured with two storage partitions and a shared cleaning partition. Each storage partition has an entry/exit pool and a storage pool.

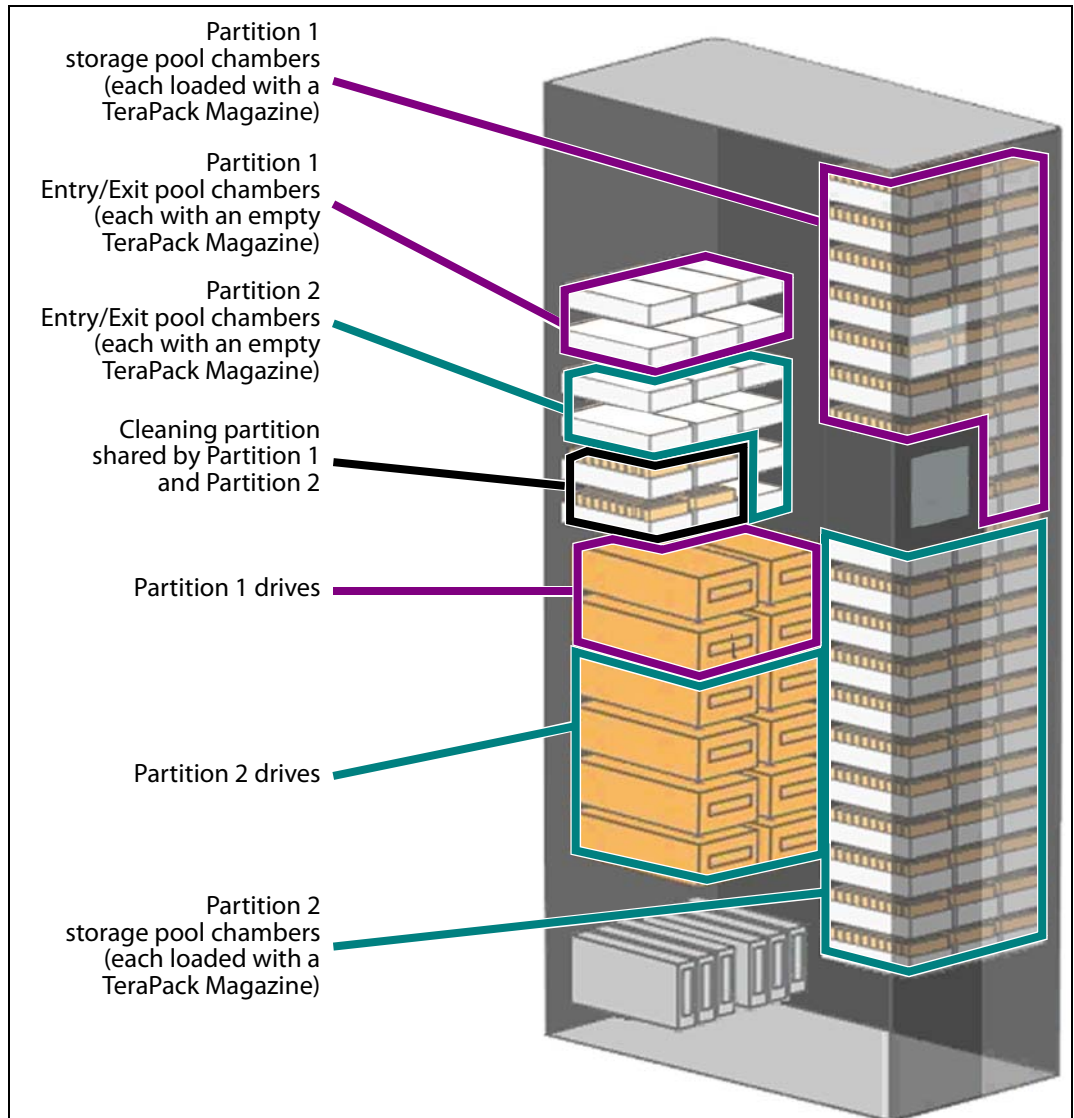

Figure 15 A library with two storage partitions and one shared cleaning partition.

Storage Partitions

Overview The library requires, at a minimum, one storage partition. This is the default configuration. Each storage partition must have at least one drive and one chamber in its storage pool. Drives and chambers can only be assigned to one storage partition at a time; they cannot be shared by multiple partitions.

When additional partitions are needed, the library uses Shared Library Services (SLS) virtualization technology to create the additional partitions. SLS support is an option you can add to the library by purchasing an activation key from Spectra Logic.

In some environments, using multiple storage partitions is crucial to data center efficiency and growth. For example, multiple partitions are extremely useful in the following situations:

Multiple Storage Management Software Packages If groups within your company use different storage management software packages, each software package requires its own dedicated library. Instead of maintaining multiple physical libraries — one per backup package — the data center can use a single Spectra Logic library with multiple partitions, in which each partition appears to the software as a dedicated library.

Multiple Databases If your company uses multiple databases, partitioning the library preserves the backup processes associated with each type of database.

Shared Resources If each department in the company must keep their data segregated, partitioning the library supplies this segregation, as well as the subsequent integrity of the data set. Each partition can only access the drives and cartridge locations assigned to it. Data from other partitions cannot become intermixed with the data stored on the media in the partition's inventory.

Multiple Drive Generations If your data center uses multiple generations of LTO drives, Spectra Logic strongly recommends configuring separate partitions for each generation to ensure read/write compatibility between the drives and cartridges.

Encryption If you want to encrypt some, but not all of your backup data, you can partition the library into an encryption partition and non-encryption partition to segregate the two types of data.

Cleaning Partitions and Auto Drive Clean

Overview The cleaning partition provides permanent storage for cleaning cartridges inside the library when the Auto Drive Clean feature is enabled. This special-purpose partition does not have an entry/exit pool or any drives associated with it. A single cleaning partition can be shared by multiple storage partitions.

Auto Drive Clean uses the cleaning cartridges in the cleaning partition to provide library-based cleaning of drives with minimal user intervention. Automated drive cleaning results in fewer failed tape read/write operations and is the preferred method for cleaning drives.

Drives in a partition with Auto Drive Clean enabled are cleaned no more than once in any 12 hour period. The library posts a message if an Auto Drive Clean does not occur because of the 12 hour restriction. If you want to clean the drive immediately, you can initiate a manual cleaning.

Note: Software-initiated drive cleaning operations cannot use the cleaning cartridges stored in a cleaning partition; the cartridges are not accessible to the storage management software.

Requirements The Auto Drive Clean feature requires a cleaning partition to be associated with the storage partitions that contain the drives you want to clean. Cleaning partitions are created separately and then assigned to one or more storage partitions (see [Creating a Cleaning Partition on page 166](#) and [Allocate Chambers and Drives on page 176](#)).

The cleaning cartridges used in a cleaning partition must be stored in specially labeled Maintenance TeraPack magazines. The cartridges themselves must be identified with “CLN” at the beginning of the barcode sequence on their labels. The library prevents you from importing cleaning cartridges and magazines that are not properly labeled into a cleaning partition.

Auto Drive Clean Operation The drives that are in a storage partition with an associated cleaning partition are cleaned automatically when cleaning is required. When a drive is unloaded in response to a host request and the data cartridge is moved to its storage location, the library queries the drive to determine if it needs cleaning. If cleaning is required, the library delays notifying the host that the SCSI move command for the unloaded data cartridge is complete while it performs an automatic drive cleaning.

During the delay, the library retrieves a cleaning cartridge from the cleaning partition and inserts it into the drive. When the cleaning is complete, the library returns the cleaning cartridge to the cleaning partition and notifies the host that the SCSI move command for the unloaded data cartridge is complete. The library then posts a system message that the cleaning was successful.

In addition to automatic cleaning, you can use the BlueScale user interface to initiate a manual cleaning operation using a cleaning cartridge stored in the cleaning partition. Only drives in a storage partition that has an associated cleaning partition can be cleaned using this method.

Expired Cleaning Cartridges When an expired cleaning cartridge is loaded into a drive, it is immediately ejected without attempting the cleaning. The library flags the cleaning tape as expired and generates system messages to notify you of the expired cleaning tape and the failed drive cleaning. It marks the cleaning cartridge as expired in its inventory and does not attempt to use it for subsequent cleanings. These cartridges have an “x” next to the slot number when viewed on the Inventory screen.

If the cleaning partition contains another, good cleaning cartridge, a cleaning that failed because the cleaning cartridge is expired, is reattempted the next time the host unloads a data cartridge from the drive.

MLM Tracking of Cleaning Cartridges When you enable the BlueScale Media Lifecycle Management (MLM) feature and use MLM-enabled cleaning cartridges, the library stores usage information, including the number of cleans remaining and the cartridge health (good, near expiration or expired), in the MLM database. This information is retained in the MLM database even when a cleaning cartridge is exported from the library.

When a cartridge is nearing the end of its useful life, the library notifies you so that you can replace the cartridge. This early notification helps prevent failed cleanings resulting from using an expired cleaning cartridge.

The library does not store any information about non-MLM cleaning cartridges in the MLM database. However the library does mark an expired cleaning cartridge and does not attempt to use it again as long as it remains in the library. If an expired non-MLM cartridge is exported and then reimported into the library, it is identified as expired the next time it is loaded into a drive.

Note: TS11xx technology cleaning tapes are always treated as MLM-enabled by the BlueScale software.

See [Chapter 9 – Configuring and Using Media Lifecycle Management](#), beginning on [page 243](#) for detailed information about MLM.

DRIVE AND MEDIA FRAMES

The T950V library’s modular design makes it possible to increase media capacity or the number of drives in the library to meet storage and performance needs as they evolve. Expansion frames can be added to the basic single-frame library for a maximum of eight frames.

As viewed from the front of the library, the main frame must be positioned as the left-most frame. Up to four drive expansion frames can be located immediately to the right of the main frame. Media frames can be located to the right of the main frame and any drive frames.

The following table shows the number of media storage chambers, slots, and drives in each type of frame in the T950V library.

Frame Type	Number of Chambers ^a	Number of slots	Maximum Number of Drives
LTO Library			
T950V main			
▪ 1 DBA/shelves	100	1000	4
▪ 3 DBAs/shelves	92	920	12
▪ 6 DBAs	80	800	24
Drive expansion (optional)			
▪ 3 DBAs/shelves	107	1070	12
▪ 6 DBAs	89	890	24
Media expansion (optional)	130	1300	None
TS11xx Technology Library			
T950V main			
▪ 1 DBA/shelves	82	738	4
▪ 3 DBAs/shelves	76	684	12
▪ 6 DBAs/shelves	66	594	24
Drive expansion (optional)			
▪ 3 DBAs/shelves	90	810	12
▪ 6 DBAs	75	675	24
Media expansion (optional)	110	990	None

a. A single magazine is stored in each chamber. Each LTO magazine contains 10 slots. Each TS11xx technology magazine contains 9 slots.

COMPONENT IDENTIFIERS

The library's BlueScale user interface and the XML command interface use component identifiers for each drive and RIM. These identifiers also appear in system messages. The component identifier is based on the component's location relative to the frame and drive bay assembly (DBA) where it is installed.

The relationships between the DBAs and the locations of the drives and controllers are the same in each main frame and drive expansion frame. In a multi-frame library, the frames are numbered sequentially from left to right when viewed from the front, beginning with the left-most frame (FR1).

- Notes:**
- All component identifiers are numbered consecutively by type, starting at 1.
 - DBAs are numbered from the bottom up, with DBA 1 being the bottom-most.
 - Drives are numbered from left to right and bottom to top in a DBA, as viewed from the back of the library. Each DBA can hold up to four full-height drives.
 - If the frame contains DBAs and shelves, the DBAs are installed from top to bottom with shelves below.

Figure 16 shows the relationship between the DBAs and the locations of the drives and controllers in the main frame.

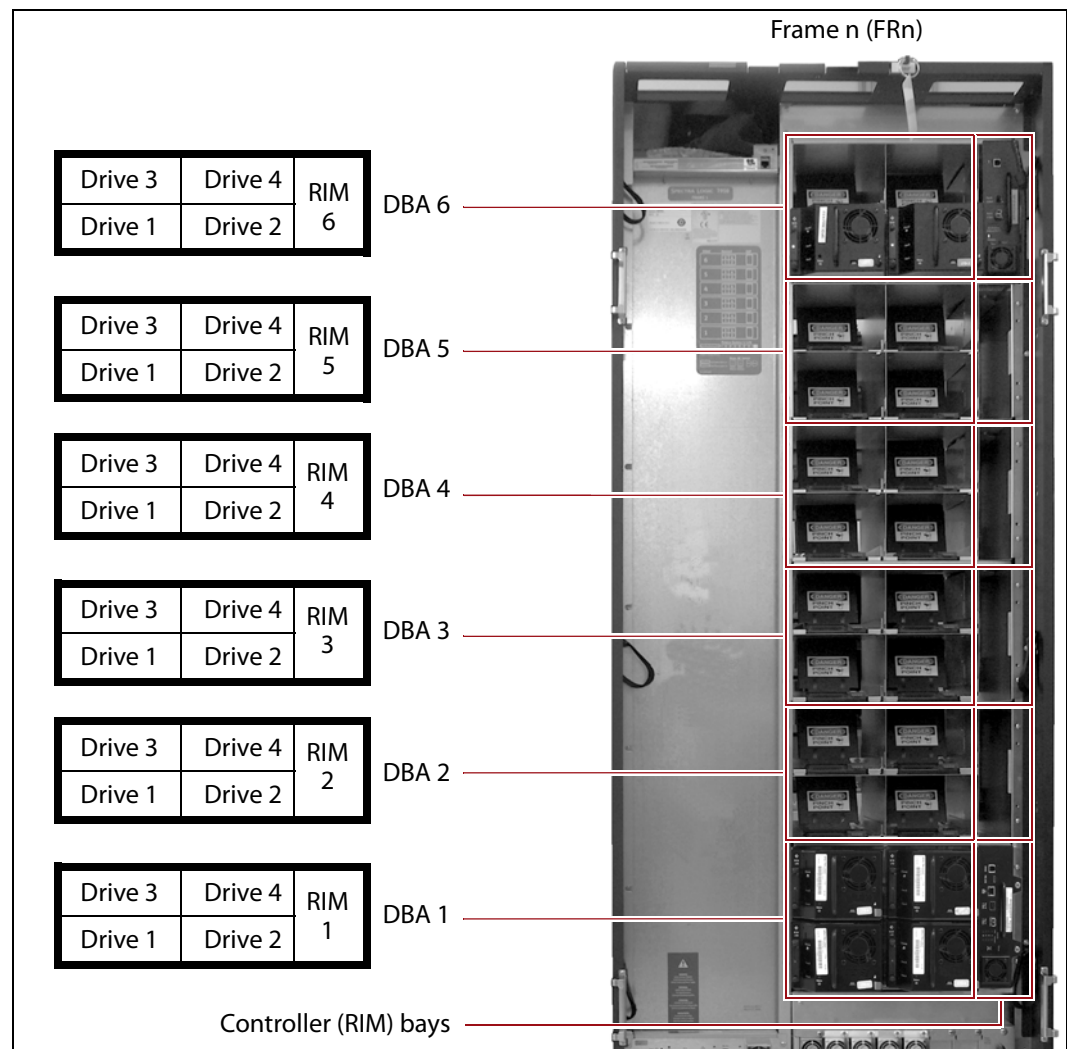

Figure 16 The relationship between the DBA, the component locations, and the identifiers in the BlueScale and XML interfaces (main frame with RIMs shown).

RIM2 Identifiers

RIM2s can be installed in any controller bay in the main frame or drive expansion frames. The component identifier for a RIM2 is based on its location relative to the frame and the DBA where it is installed.

The component identifier for a RIM2 is shown as **FRx/DBAx/F-QIPn**, where:

- **FRx** is the number of the frame from left to right when viewed from the front of the library.
- **DBAx** is the number of the DBA where the RIM2 is installed (see [Figure 16 on page 56](#)). The main frame and each drive expansion frame accommodates up to six DBAs.
- **F-QIPn** is the interface type (Fibre Channel) of the RIM2 and the number of the controller bay where it is installed. Because each DBA contains only one controller bay, **n** is always 1.

Note: The component identifier for a RIM2 shows it as an F-QIP. For example, [Figure 17](#) shows the component identifier for the RIM2 installed in DBA 4 in Frame 1 (**FR1/DBA4/F-QIP1**) on the Controllers screen. The device descriptor (**8-Gbps FC RIM2**) indicates that the controller is a RIM2.

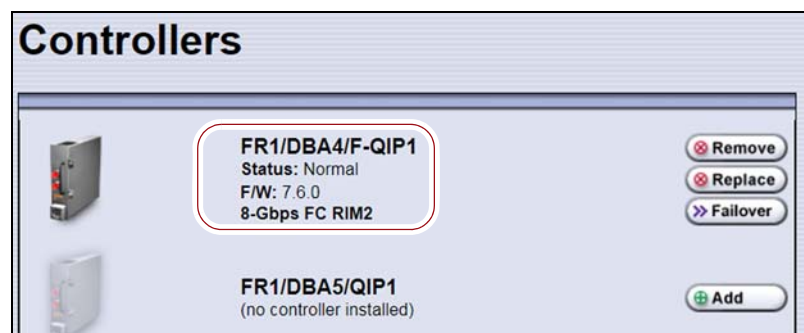

Figure 17 The Controllers screen showing the component identifier for a RIM.

Drive Identifiers

The firmware in the drive sled that houses each drive assigns an identifier to the drive based on its location in the library. This identifier is shown in the BlueScale user interface and is used in the XML command interface. The identifier is also used to generate the World Wide Name (WWN) that the library reports for the drive (see [World Wide Names for Fibre Channel Drives on page 65](#)). Because the identifier is location-based, it remains constant even if the physical drive is replaced by a new drive. The new drive assumes the location-based identifier.

The component identifier for each drive is based on its location relative to the frame and the DBA where it is installed, as viewed from the back of the library (see [Figure 16 on page 56](#)). The component identifier for a drive is shown as **FRx/DBAx/fTYPE-DRVx**, where:

- **FRx** is the number of the frame from left to right when viewed from the front of the library.
- **DBAx** is the number of the DBA containing the drive.
- **xTYPE** is the interface (x= f for Fibre Channel or s for SAS) and drive type (LTO for an LTO drive or TS11x0 for a TS11xx technology drive).
- **DRVx** is the number of the drive bay in the DBA, as viewed from the back of the library. A is added to the end for half-height drives.

For example, [Figure 18](#) shows the component identifier for a half-height Fibre Channel LTO drive installed in drive bay 1 of DBA 3 in Frame 2 (**FR2/DBA3/fLTO-DRV1A**) on the Drives screen. The **Drive Type** descriptor indicates that the drive is an IBM Ultrium-TD8 half-height Fibre Channel drive.

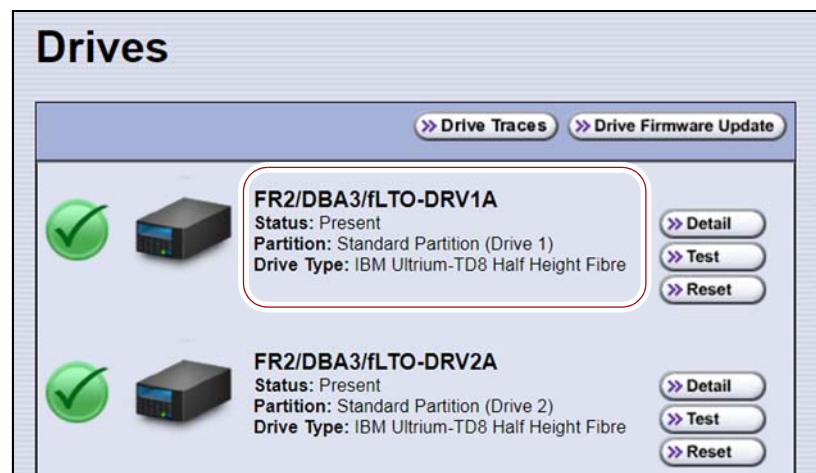

Figure 18 The Drives screen showing the component identifier for a drive.

FIBRE CHANNEL CONNECTIVITY

The library's robotics and the library's drives connect to the host system over a Fibre Channel arbitrated loop or fabric or a SAS fabric. These connections carry two types of information:

- The commands from the storage management software that control the robotic motion and the read/write operations of the drives.
- The data being transferred to and from a drive by the host.

The following sections describe Fibre Channel connectivity for the library's robotics and the drives.

Robotic Controller Connectivity

The library requires either an LTO drive or a RIM2 to provide the robotic control path. When configuring a storage partition, the device you select to provide the robotic control path is referred to as the “exporting controller” for the partition. The exporting controller makes the partition accessible to the hosts as a media changer (a library). It receives the media changer commands sent from the host to the library and relays them to the RCM, which in turn processes them into the motion commands used to control the robotics.

You can select multiple exporting controllers (drives or RIM2s) for a partition and use your host software to export the same changer interface over the controllers to provide redundancy.

- When a RIM2 is not present, a direct-attached Fibre Channel or SAS drive provides the robotic control path, as described in [Control Path Through a Direct-Attached Drive](#), below.
- When a RIM2 is present, it can be used to provide the robotic control path, as described in [Control Path Through a RIM2 on page 60](#).

Control Path Through a Direct-Attached Drive

In a direct-attached drive configuration, one or more drives in a storage partition are designated as the exporting drive (also known as the exporting controller). The commands from the host to control the motion of the robotics within the partition are routed to the exporting drive’s logical unit number 1 (LUN 1). Commands to control the operation of the exporting drive are sent from the host to LUN 0 of the drive.

- Notes:**
- If you have multiple storage partitions, you must designate an exporting drive for each partition.
 - A drive can only provide the robotic control path for the partition to which it is assigned.
 - You can select multiple drives as controllers, and export the same changer interface over the drives to provide redundancy, as long as your storage management software can support this. These multiple paths cannot be used at the same time.
 - Assigning multiple drive exporters to one partition reduces the total number of partitions that can be configured in the library.

Figure 19 shows an example of a partition with two Fibre Channel drives providing the robotic control path. LUN 1 on the drives provides the robotic control path over which the commands to the robotics are received from the host.

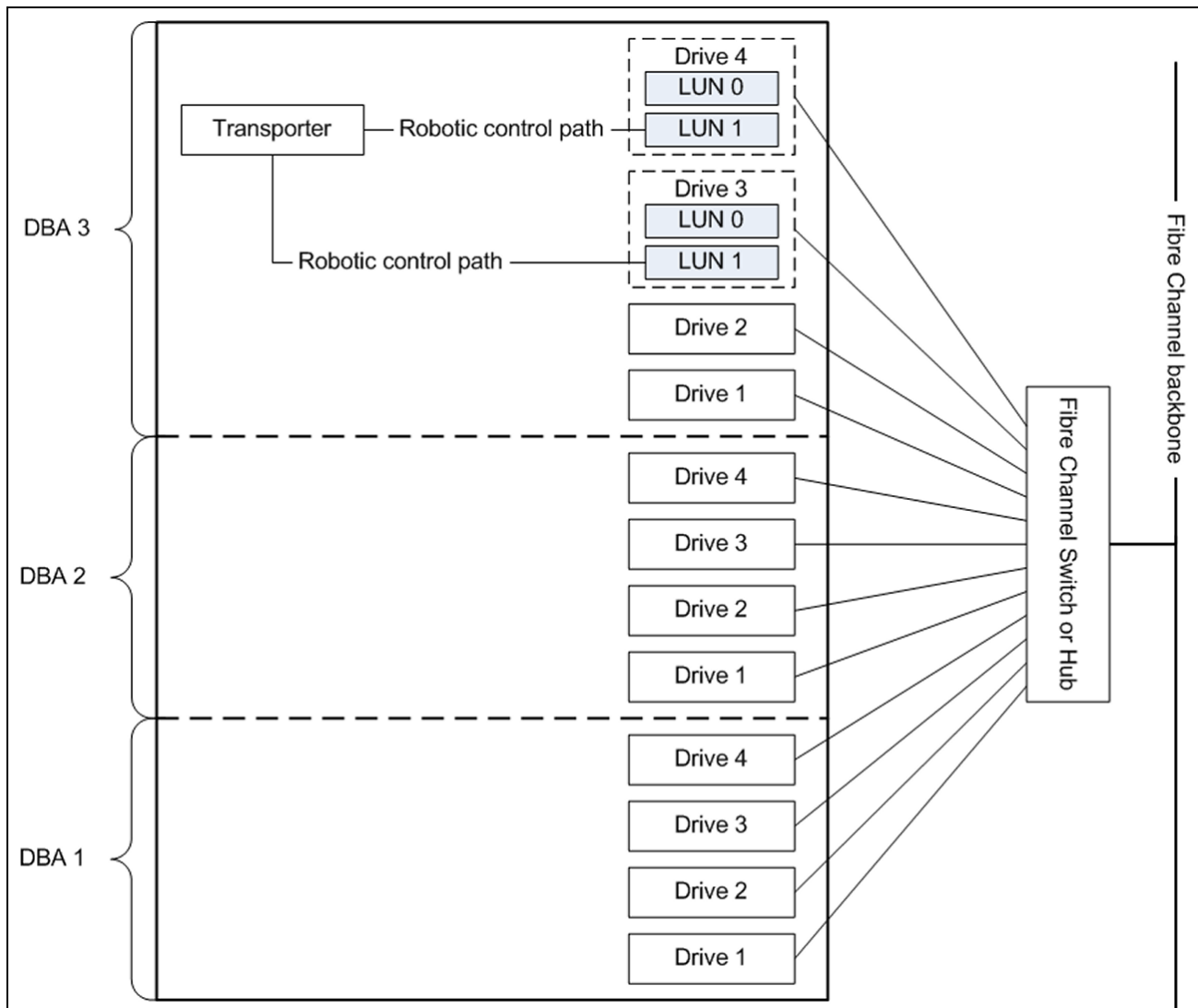

Figure 19 An example of a partition with two direct-attached Fibre Channel drives providing the robotic control path.

Control Path Through a RIM2

In a RIM2-based configuration, a RIM2 is the exporting controller for the partition. This controller provides the bridge between the external Fibre Channel interface from the host and the internal interface used by the library to communicate with the robotics.

A RIM2 can support up to 16 partitions. Each partition has full control of the robotics. For example, if the library contains two partitions, a single RIM2 can provide the robotic control path for both partitions.

If the library contains two RIM2s, it can be configured to use the BlueScale Controller failover feature. This feature configures the two controllers as a failover pair to provide a redundant control path to the robotics (see [Controller Failover on page 66](#) for additional information).

If desired, you can configure multiple RIM2s as exporters for the same partition and use your host software to export the same changer interface over the RIMs to provide redundancy. These multiple paths cannot be used at the same time.

[Figure 20](#) shows an example of a partition with direct-attached Fibre Channel drives and a RIM2. Port A on the RIM provides the robotic control path over which the commands to the robotics are received from the host.

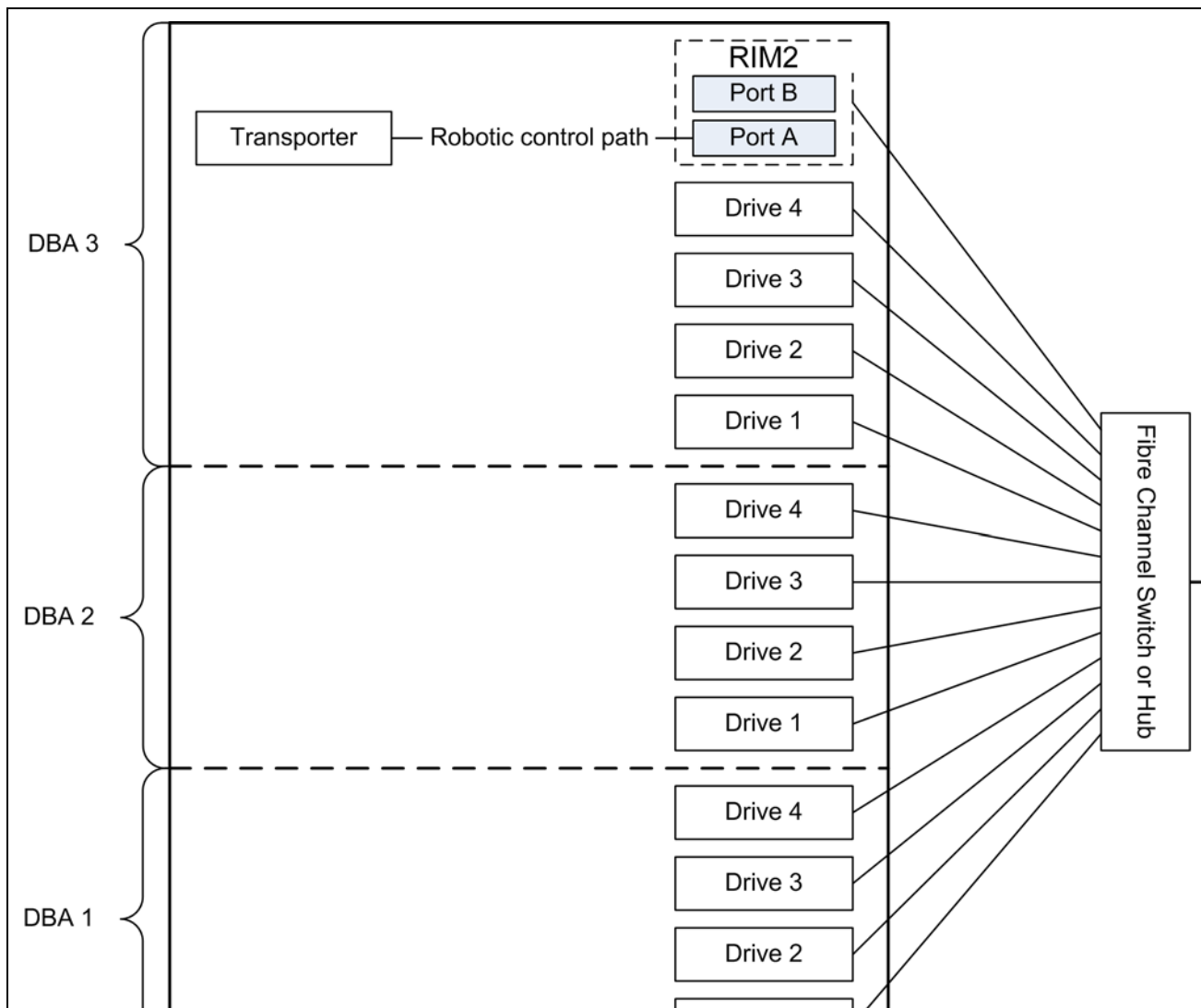

Figure 20 An example of a RIM2 in a partition with direct-attached Fibre Channel drives.

World Wide Names for Fibre Channel Partitions

The World Wide Name (WWN) displayed for each partition on the Shared Library Services screen is the WWN of the controller (RIM2 or drive) that provides the robotic control path for the partition (the exporting controller). The WWN is based on the physical location of the controller in the library and remains constant even if the controller is replaced. The new controller assumes the location-based WWN.

Note: If multiple exporting controllers are configured in a partition, there are multiple WWNs for the partition. Click **Summary** to display the Partition Settings screen, which lists all of the WWNs.

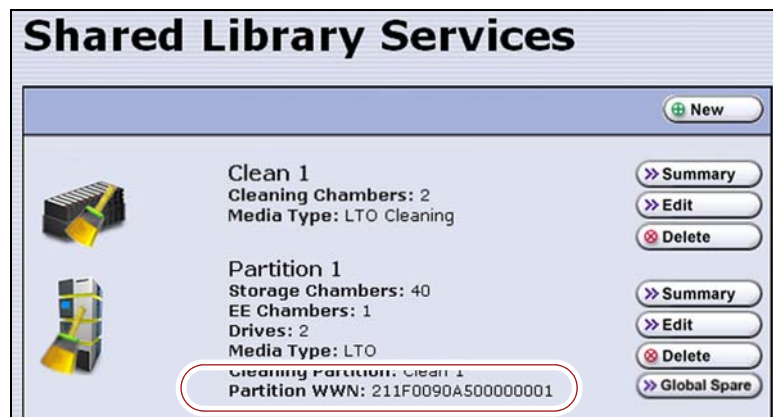

Figure 21 The WWN assigned to the partition.

For Partitions with RIM2s as the Exporting Controller

- The partition WWN is actually the World Wide Node Name (WWNN) for the exporting controller.
- If multiple partitions use the same Fibre Channel port on the RIM2, all of the partitions have the same WWNN and the same World Wide Port Name (WWPN). However, the partitions will have different LUNs under those controllers, starting at LUN zero (0).
- If you create two partitions and configure one partition to use Port A and another to use Port B, the WWNN/WWPN of port A will start with 21 and the WWNN/WWPN of port B will start with 22. In this case the ports are independent. However, both of the partitions will show the WWN for Port A only.
- If you export the same partition out both port A and port B on a RIM2, the WWNN will be the same for both ports but the WWPN will be different. This scenario is a type of redundant path to the robotics.
- For more information about WWNs, log on to the portal (see [Accessing the Technical Support Portal on page 444](#)), open the Knowledge Base, and in the KBA field, enter 01764 to access the article *Spectra Library World Wide Names (WWNs) for QIPs* (the article discusses F-QIPs; the concepts are the same for a RIM2).

For Partitions with a Drive or Drives as the Exporting Controller

- The partition WWN is the same as the WWN for the drive. The commands to control the motion of the robotics within the partition are sent from the host to the exporting drive's logical unit number 1 (LUN 1). Commands to control the operation of the exporting drive are sent from the host to LUN 0 of the drive.
- See [World Wide Names for Fibre Channel Drives](#) on page 65 for more information about WWNs for drives.

Fibre Channel Port Configurations

One or both of the external ports on the exporting controller can be used to provide the network connectivity for the robotics.

Single Port Connectivity The simplest configuration uses only one of the interface ports on the exporting controller. This configuration works well when only a single host is connected to the library. When multiple hosts are connected to the same port, they must share this single communication path to the robotics. This type of configuration requires the hosts to use device sharing application software to handle the arbitration for use of the robotics.

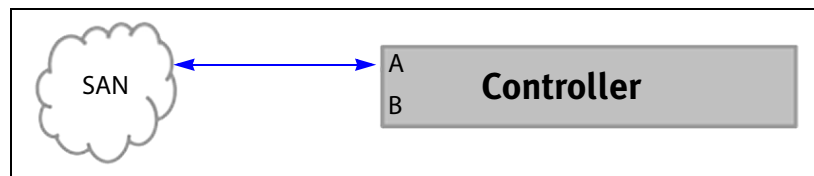

Figure 22 Single port network connectivity to the exporting controller.

Dual-Path Connectivity (RIM2s only) A slightly more complex configuration uses both interface ports on the exporting controller with each connected to a different library partition. Each port is used as an independent communications path. From a host perspective, each port is viewed as a unique, independent path to a partition. The two ports can be connected to the same or possibly different storage area networks (SANs). The library processes the motion commands and relays them to the partitions in the order that they are received. This is a way to provide limited visibility between the partitions. If you have more than two partitions you can use additional controllers to provide additional isolation between partitions.

Dual-Port Connectivity As an alternative to the configurations that use a single port for each partition, dual-port configurations use both interface ports as a single communications path to the same partition. The ports can be connected to the same or different SANs. The hosts on the network can use either port to communicate with the robotics. A dual-port configuration allows a host to have an alternate, redundant, path to reach the partition. Not all host software can support this type of configuration.

- Notes:**
- The two ports cannot be used simultaneously.
 - This type of configuration cannot be used in combination with the Controller Failover feature (see [Controller Failover on page 66](#)).

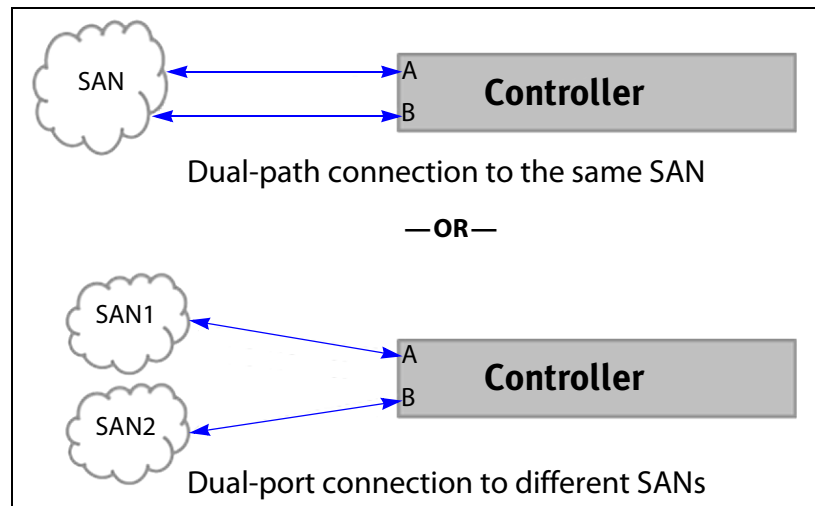

Figure 23 Examples of a dual-path and dual-port configurations.

Drive Connectivity

The drives in the library have either a Fibre Channel or a SAS interface.

- Fibre Channel drives connect directly to the host using a Fibre Channel arbitrated loop or fabric, as described in [World Wide Names for Fibre Channel Drives](#).
- Serial Attached SCSI (SAS) drives connect directly to a SAS HBA.

Keep in mind that all of the drives on an arbitrated loop must share the data transfer capacity (bandwidth) of the interface. Having multiple devices on the same loop can negatively impact the performance of all the devices.

World Wide Names for Fibre Channel Drives As part of providing network connectivity, the drive sled firmware assigns a location-based WWN for the drive it houses. This WWN is displayed on the Drive Details screen and can be used by the host software to address the drive. Because this WWN is location-based, it remains constant even if a drive is replaced by a different one of the same type. The new drive assumes the location-based BlueScale identifier and WWN.

Note: The WWN displayed on the Drive Details screen is actually the WWPN for port A on the drive sled. The WWPN for port B is the same as the one for port A except that the second digit from the left is 2 instead of 1.

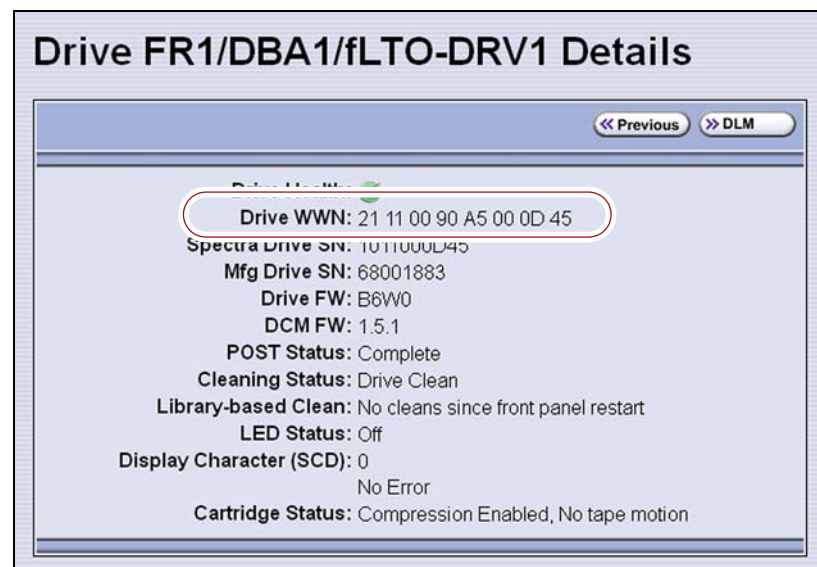

Figure 24 The WWN assigned to a Fibre Channel drive.

HIGH-AVAILABILITY CONFIGURATIONS

In high-availability enterprise environments, keeping the library operating even in the event of a network connection failure or component failure is extremely important. The following sections describe the high-availability features of the T950V library.

Redundant Connectivity

In a high-availability environment, the ability to maintain communications between the host systems and the library and its drives in the event of a connection failure is essential.

- The library can be configured to use two controllers (RIM2s) and the BlueScale Controller Failover feature to provide redundant connectivity to the media changer functionality of the library. See [Configure Controller Failover on page 119](#) for information about configuring controller failover.



Important

The controllers must be running the same firmware version. If you install the second controller after you update the BlueScale software, the BlueScale versions for the two controllers may be different. Update the BlueScale software as described in [Updating the BlueScale Software and Library Firmware on page 388](#) to correct the reported firmware mismatch.



Important

Drives used to provide the robotic control path cannot be configured with controller failover, however you can export the same changer interface over multiple drives in the partition to provide redundancy as long as your software can support this. These multiple paths cannot be used at the same time. Assigning multiple drive exporters to one partition reduces the total number of partitions that can be configured in the library.

- The servers and switches used to access the full-height Fibre Channel drives in the library can use failover software to provide redundant connectivity through the two ports on each drive.

Controller Failover

The BlueScale Controller Failover feature uses two RIM2s failover pair. One controller in the pair is the primary controller and the other is the secondary controller. From the host perspective, the primary controller is the only controller present. The secondary controller is not visible to the host.

Figure 25 shows a simplified view of how the failover pair operates. Port A on each controller in the pair is connected to the same Fibre Channel switch. Both ports have the same configuration, except that the primary operates in target mode and the secondary is not active.

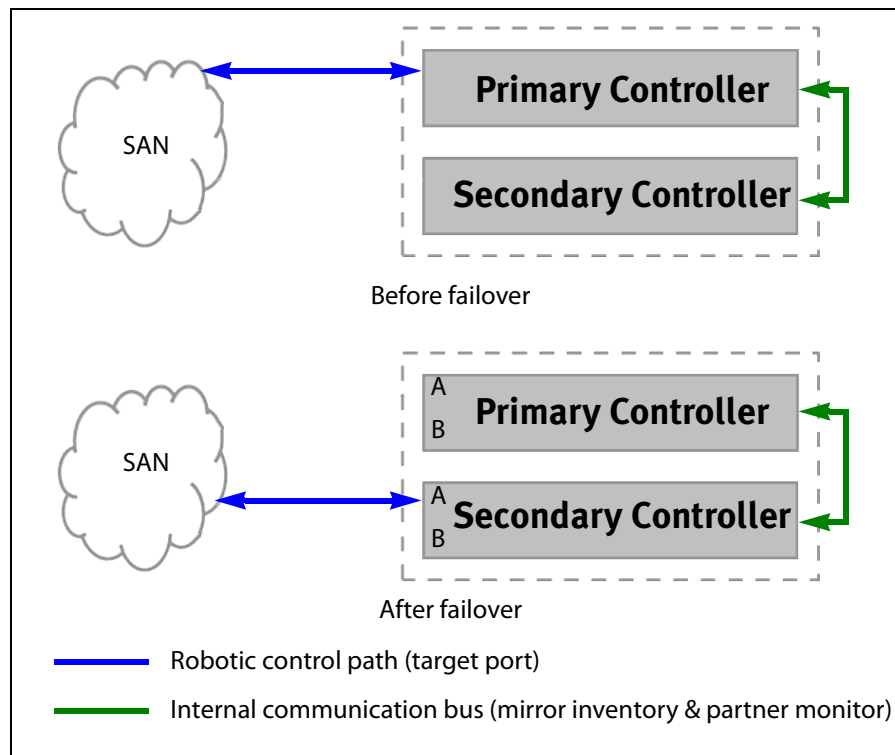

Figure 25 Paired controllers configured to provide failover redundancy.

The two controllers use the library's internal communication bus to monitor each other and to maintain a cache of the library's inventory database.

A failover event occurs when the secondary controller detects that the primary controller is no longer communicating on the library's internal communication bus. After sending a query to the primary controller to confirm that it is no longer communicating, the secondary controller takes over the exact configuration of the primary controller and begins receiving and processing the media changer commands sent from the host.



Important

Only the secondary controller (acting as primary) is functional after the failover. A failure on this controller disrupts communications with the hosts. Troubleshoot the cause of the failover and reconfigure Controller Failover as soon as possible.

BlueScale Controller Failover allows backups to continue in the event that library communication to the primary controller is disrupted. Because both controllers are connected to the same Fibre Channel switch and maintain a synchronized image of the library's inventory database, the failover occurs without manual intervention. You can then troubleshoot the failed controller at your convenience.

After you resolve the problem, the controller that originally caused the failover becomes the secondary controller in the failover pair. The failover pair reverts to the original primary/secondary relationship the next time the LCM is restarted.

The BlueScale Controller Failover feature only affects the operation of the library's controllers. Controller Failover does not detect if the controller is accessible by the host. To take advantage of the feature, the host must be configured to retry failed commands. This ensures that commands that fail when the library connection to the primary controller is disrupted get re-issued after the connection to the secondary controller is established. The retry timing must be configured to allow for the time lag inherent in the process of disabling the host's connection to the primary controller and enabling the connection to the secondary controller.

Exporting Drive Redundancy

As an alternative to controller failover or for drives, which cannot be configured with controller failover, you can select multiple drives or RIM2s as controllers for a single partition, and export the same changer interface over them to provide redundancy, as long as your data storage software can support this.

Note: Assigning multiple drive exporters to one partition may reduce the total number of partitions that can be configured in the library.

Drive Connectivity Failover

The full-height Fibre Channel drives used with the library are equipped with two Fibre Channel ports. The two Fibre Channel ports cannot be used simultaneously to provide redundant data paths between the hosts and the drive. However, they can be used to provide failover capability in the event that communication to the port currently in use is interrupted. This failover can be accomplished several ways, including:

- Manually disconnect the fiber optic cable from the failed port and connect it to the other port. You may need to reconfigure your host software to recognize the alternate port.
- Connect each port on the drive to a separate Fibre Channel HBA in the host. You can also use a dual-port Fibre Channel HBA. Configure one HBA (or HBA port) as the primary connection and the other HBA (or HBA port) as the failover connection. Install failover software on the host computer to control the transfer of I/O from one HBA to the other in case of a failure. You may also need to configure your storage management software to correctly recognize both ports. Refer to your failover software, HBA, and storage management software documentation for instructions.

Note: Tape drives sold by Spectra Logic do not support MPIO.

Global Spare Drives

The BlueScale Global Spare feature provides a way to remotely substitute an available TS11xx technology or Fibre Channel LTO drive in the library for a failed drive of the same type. The feature lets you configure an installed drive as a designated spare for other drives in the library. This drive can then be substituted for a failed drive in any partition that is configured to use the Global Spare drive. When a drive fails, you simply log into the BlueScale web interface from any location, select the Global Spare option for the failed drive, and continue normal operations. You can then physically replace the failed drive at your convenience. See [Assign Global Spare Drives on page 173](#) and [Using a Global Spare Drive on page 352](#) for more information.

Redundant Power Supplies

The library requires one 5/12 VDC power supply per DBA with an installed drive. Installing an optional N+1 power supply, where N is the number of DBAs with drives installed, provides redundancy and failover protection in the event that a single power supply fails. In a library with three DBAs, if four or more power supply modules are installed, up to two power supplies can fail. The surviving power supplies load-share in order to provide sufficient power to the DBAs to allow backups to continue until the failed power supplies are replaced.

The library main frame requires one 24 VDC power supply to provide power for the library robotics, motors, fans, and interior LED light bars. An additional 24 VDC supply can be installed to provide redundancy.

The main frame and each drive frame have both a primary and a secondary AC power input. When using a redundant AC power configuration, each input for a frame is connected to a separate branch circuit, which allows for failover in the event of a power failure in one of the circuits.

CHAPTER 3

Introducing the BlueScale User Interface

The BlueScale user interface is used for configuring, monitoring, and maintaining the T950V library. The user interface displays on a color touch screen on the front of the library. It can also be displayed remotely through a standard web browser using the Remote Library Controller (RLC) or on a monitor connected directly to the LCM.

Note: The XML command interface can also be used to perform many of the functions provided by the BlueScale user interface. See the *Spectra Tape Libraries XML Command Reference* for detailed information about using the XML command interface.

This chapter describes the BlueScale user interface and how it is used.

Topic	
Overview of the BlueScale User Interface	page 71
Access Options	page 71
User Interface Features	page 73
Library Management	page 81
Using the BlueScale User Interface	page 82
Log Into the User Interface	page 82
Log Off or Switch Users	page 86
Enter Information on Screens	page 87

OVERVIEW OF THE BLUESCALE USER INTERFACE

The BlueScale user interface lets you set configuration options, view library and drive information and metrics, manage media, monitor library operations, and perform maintenance operations.

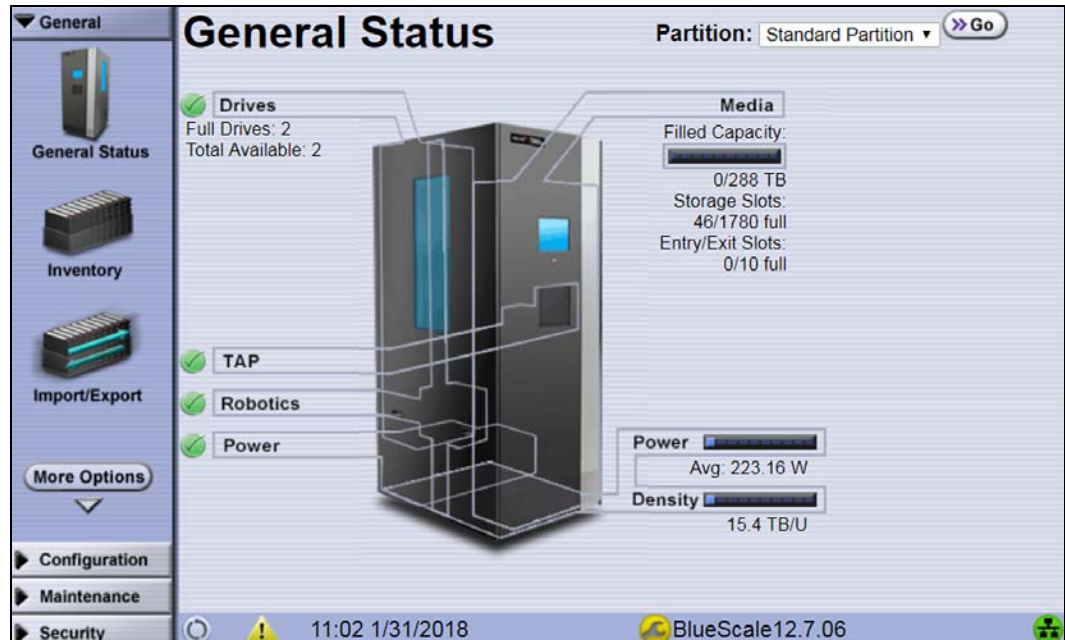

Figure 26 The BlueScale user interface General Status screen.

Access Options

The BlueScale user interface is accessed using either the touch screen on the library operator panel or through the BlueScale web interface.

Operator Panel Touch Screen Interface

The touch screen on the operator panel of the main frame is the library's local BlueScale user interface. You select options and enter information by simply touching the appropriate location on the screen with a stylus or your finger. The touch screen interface includes a soft keyboard that you can use to enter alphanumeric characters into text fields. This soft keyboard can be accessed from the keyboard icon that displays whenever text input is required.

In addition to using the touch screen, you can access the local user interface using a monitor, keyboard, and mouse connected directly to the LCM (see [Figure 9 on page 39](#)). This method of accessing the local BlueScale user interface provides the same functionality that is available from the touch screen.

**Important**

Do not use the **Enter** key on your keyboard when making selections in the BlueScale user interface. It can cause inconsistent behavior in the BlueScale interface.

BlueScale Web Interface

The BlueScale web interface lets you use a standard web browser to access the library through the Remote Library Controller (RLC). Simply enter the library's IPv4 or IPv6 address into a browser running on a computer that can access the Ethernet network to which the library's LCM is connected.

**Important**

- When accessing the library remotely through a web browser, do not use the **Enter** key on your keyboard when making selections in the BlueScale user interface. Various web browsers handle the **Enter** key differently, causing inconsistent behavior in the BlueScale interface.
- Always use your mouse to make selections and click the buttons in BlueScale screens instead of using your keyboard.
- Do not use the browser's "back" button to return to a previously viewed BlueScale screen. Always use the BlueScale toolbar and buttons on the screen to navigate the BlueScale web interface.
- Using a keyboard command (for example, **F5**) to refresh the browser when connected to the BlueScale web interface can cause unpredictable results.

The BlueScale web interface provides access to the same features and functions that are available through the touch screen, excluding functions that involve physical interaction with the library (for example, using the TAP to import or export a TeraPack magazine).

When using the web interface, keep the following requirements in mind:

Number of Sessions The BlueScale web interface supports up to eight simultaneous connections to the library. If you attempt to establish more than eight simultaneous web interface connections, the existing connection with the longest idle time is terminated.

Supported Browsers Remote access to the library through the web interface is only supported using the following web browsers:

- Microsoft® Internet Explorer®
- Mozilla® Firefox®
- Google® Chrome™
- Apple® Safari®

Additional browsers were not fully tested with the BlueScale web interface. Using an unsupported browser may result in the BlueScale web interface not displaying or operating as expected.

User Interface Features

The following sections describe the common features that appear in all screens in the user interface.

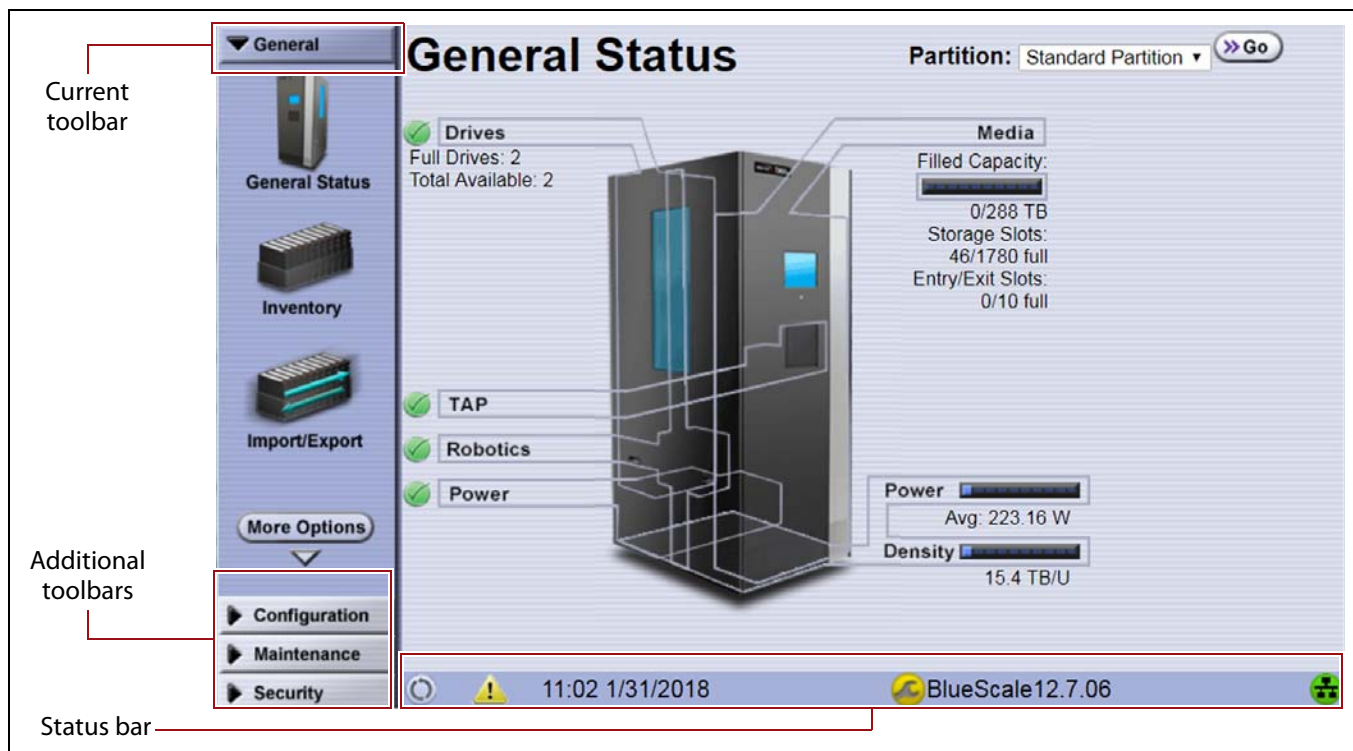

Figure 27 The BlueScale user interface features.

Toolbars

The toolbar panel appears along the left edge of each screen (see [Figure 27](#)) and lets you navigate through the available toolbars to select options. Clicking on a toolbar expands it to display the available options. The screen for the previously selected option remains displayed until you select another option, either from the same toolbar or another one.

Option Overview

The following table provides an overview of the options available under each toolbar. [Figure 28 on page 77](#) shows the sequence of the screens under each option.

Toolbar	Available Options
General	<p>The General toolbar (shown in Figure 27 on page 73) provides access to the most frequently used library screens and controls:</p> <ul style="list-style-type: none"> ▪ General Status — Displays the current status for all of the major library components for the selected library partition. Moving the cursor over the name of a component highlights the component in the system graphic. ▪ Click Drives to display the Drives screen for more detailed information about the status of the drives (see View Drive Status Information on page 153). The Drives screen can also be accessed from the Configuration toolbar (see Configuration on page 75). ▪ Click Robotics to display the Robotics Status screen, which provides access to the Tools and Usage tabs. Select the Tools tab to access the Run All Motion Basic Tests diagnostic (see Testing the Robotics on page 337). Select the Usage tab to access the Robot Utilization feature (see View Robot Utilization Information on page 152). ▪ Click Media to display the Inventory screen, which is also accessed from the Inventory option on the General toolbar. ▪ Click Filled Capacity to display the Media Lifecycle Management Report screen, which is also accessed from the Media Lifecycle Management option on the General Status screen. ▪ Inventory — Displays the Inventory screen, which shows the library’s media inventory information. Use the controls on the Inventory screen to locate individual cartridges and move magazines and cartridges from one location in the library to another. See Chapter 8 – Using the Cartridge Inventory, beginning on page 223, to learn about the options available from this screen. ▪ Import/Export — Displays the Import/Export screen, which provides controls for importing, exporting, and exchanging magazines and cartridges. See Import and Export Overview on page 201 to learn about using the options available from this screen. <p>Note: The Import/Export option is not available when accessing the library remotely using the BlueScale web interface.</p> <ul style="list-style-type: none"> ▪ Metrics — Displays screens that show the metrics for drive performance, power consumption, and storage density for the media types in the library. See Use Performance Metrics on page 149 for information about viewing the metrics available for the library. ▪ Media Lifecycle Management — Displays the Media Lifecycle Management Report screen, which provides controls for generating media lifecycle reports. See Using MLM Reporting on page 273 to learn about using the options available from this screen.

Toolbar	Available Options
<p>Configuration</p>	<p>The Configuration toolbar provides access to controls for configuring all aspects of the library's operation:</p> <ul style="list-style-type: none"> ▪ Partitions — Displays the Shared Library Services screen, which provides information about the currently selected partition and lets you define new partitions or modify existing partitions. See Chapter 6 – Configuring and Managing Partitions, beginning on page 159, to learn about configuring and using both storage and cleaning partitions in your library. ▪ Drives or DLM — Displays the Drives screen, which lists all of the drives installed in the library. Depending on the library configuration, the screen offers options for performing different types of operations on each drive. If Drive Lifecycle Management (DLM) is enabled, the Drives icon in the Configuration toolbar changes to DLM. The Drives screen changes to include a DLM status icon next to each drive. This icon provides at-a-glance information about the general health of the drive. See View Drive Status Information on page 153 and Chapter 10 – Using Drive Lifecycle Management, beginning on page 288, to learn about using the options available from the Drives screen. <p>Note: DLM is automatically enabled when you enable Media Lifecycle Management (MLM).</p> <ul style="list-style-type: none"> ▪ Controllers — Displays the Controllers screen, which provides information about the RIMs installed in the library and lets you configure a failover pair using two controllers. See Configure Controller Failover on page 119) for detailed information about configuring and using the Controller Failover feature. <p>Note: The Controllers screen may not have any entries if the library is using direct-attached drives to provide the robotic control path for partitions.</p> <ul style="list-style-type: none"> ▪ System — Displays the System Setup screen, which provides controls for enabling purchased library options and configuring the library's system-wide operating parameters. See Chapter 4 – Configuring the Library, beginning on page 89, to learn about the options available from the System Setup screen. ▪ Media Lifecycle Management — Displays the Media Lifecycle Management Setting screen, which provides controls for enabling MLM and configuring global settings for MLM. See Chapter 9 – Configuring and Using Media Lifecycle Management, beginning on page 243, to learn about using the options available from the Media Lifecycle Management Setting screen.

Toolbar	Available Options
Maintenance	<p>The Maintenance toolbar provides access to maintenance and troubleshooting options for the library and drives.</p> <ul style="list-style-type: none"> ▪ Package Update — Displays the Package Update screen, which shows the version of the BlueScale software the library is using and provides controls for updating the BlueScale software and the firmware for individual library components, managing update packages, and configuring and managing package servers. See Configure a Package Server on page 129 and Updating the BlueScale Software and Library Firmware on page 388, to learn about using the options available from the Package Update screen. ▪ Tools — Displays the Maintenance Tools screen. From this screen you can access the Utilities, System Traces, and EtherLib Status screens which provide tools used during maintenance and troubleshooting procedures. See Chapter 12 – Library Troubleshooting, beginning on page 314, and Chapter 14 – Maintaining the Library, beginning on page 384, to learn about using the options available from the Utilities, Traces, and EtherLib Status screens. ▪ Diagnostics — Displays the Diagnostics screen, which provides access to diagnostics used for testing the library during troubleshooting procedures. These tests are performed under guidance from Spectra Logic Technical Support. ▪ AutoSupport — Displays the AutoSupport screen, which provides controls for creating and maintaining AutoSupport profiles, opening and updating support tickets, and configuring AutoSupport features. See Chapter 11 – Configuring and Using AutoSupport, beginning on page 297, for detailed information about configuring and using AutoSupport. ▪ Media Lifecycle Management — Displays the Media Lifecycle Management Tools screen, which provides access to controls for using MLM features. See Chapter 9 – Configuring and Using Media Lifecycle Management, beginning on page 243, to learn about using the options available from the Media Lifecycle Management Tools screen.
Security	<p>The Security toolbar provides access to options for managing users and for configuring and using the Encryption feature for your library.</p> <ul style="list-style-type: none"> ▪ Switch User — Displays the main BlueScale Login screen, which logs the current user out of the library and lets a different user log in. See Log Off or Switch Users on page 86 for information about using this option. ▪ Edit Users — Displays the Edit Users screen, which provides tools for adding, editing, and deleting users. See Configuring Library Users on page 90, to learn about using the options available on the Edit Users screen. ▪ Encryption — Displays the Encryption Login screen. You must log into the encryption feature before you can enable and configure the encryption options, including the library’s built-in BlueScale encryption key management. See the <i>Spectra Tape Libraries Encryption User Guide</i> for information about configuring and using encryption with the library. <p>Note: BlueScale Encryption Standard Edition capability is included with the library. You can purchase an activation key for either BlueScale Encryption Professional Edition, the Spectra SKLM Encryption key management system, or KMIP Encryption key management to access additional encryption capabilities.</p>

Map of Options Available from the Toolbar

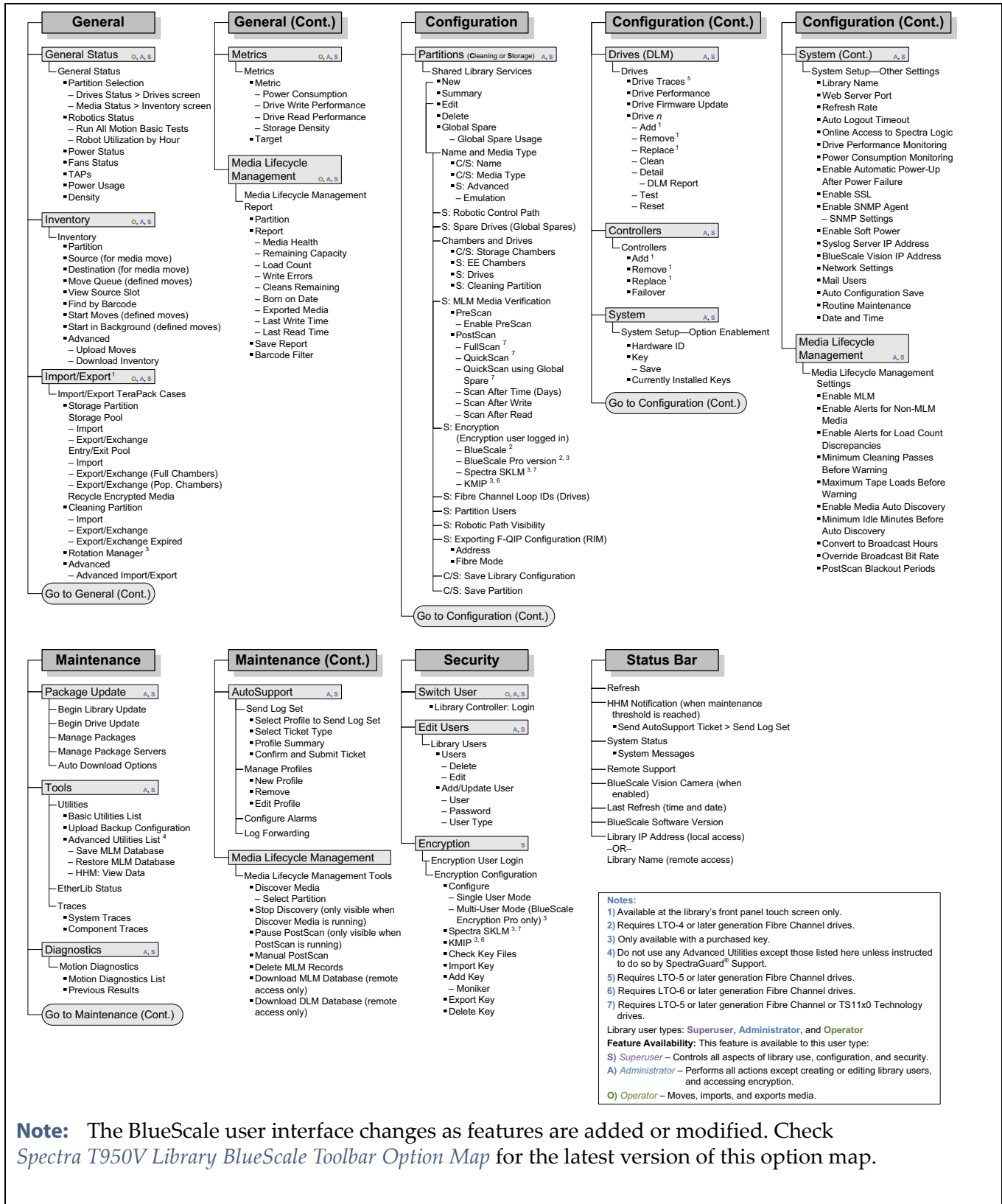

General (Cont.)

- Metrics (O, A, S)
 - Metrics
 - Power Consumption
 - Drive Write Performance
 - Drive Read Performance
 - Storage Density
 - Target
- Media Lifecycle Management (O, A, S)
 - Media Lifecycle Management Report
 - Partition
 - Report
 - Media Health
 - Remaining Capacity
 - Load Count
 - Write Errors
 - Cleans Remaining
 - Born on Date
 - Exported Media
 - Last Write Time
 - Last Read Time
 - Save Report
 - Barcode Filter

Configuration

- Partitions (Cleaning or Storage) (A, S)
 - Shared Library Services
 - New
 - Summary
 - Edit
 - Delete
 - Global Spare
 - Global Spare Usage
 - Name and Media Type
 - C/S: Name
 - C/S: Media Type
 - S: Advanced
 - Emulation
 - S: Robotic Control Path
 - S: Spare Drives (Global Spares)
 - Chambers and Drives
 - C/S: Storage Chambers
 - S: EE Chambers
 - S: Drives
 - Cleaning Partition
 - MLM Media Verification
 - PreScan
 - Enable PreScan
 - PostScan
 - FullScan⁷
 - QuickScan⁷
 - QuickScan using Global Spare⁷
 - Scan After Time (Days)
 - BlueScale⁵
 - BlueScale Pro version^{2,3}
 - Spectra SKLM^{3,7}
 - KMIP^{3,6}
 - S: Encryption (Encryption user logged in)
 - BlueScale⁵
 - BlueScale Pro version^{2,3}
 - Spectra SKLM^{3,7}
 - KMIP^{3,6}
 - S: Fibre Channel Loop IDs (Drives)
 - S: Partition Users
 - S: Robotic Path Visibility
 - S: Exporting F-QIP Configuration (RIM)
 - Address
 - Fibre Mode
 - C/S: Save Library Configuration
 - C/S: Save Partition
 - Go to Configuration (Cont.)

Configuration (Cont.)

- Drives (DLM) (A, S)
 - Drives
 - Drive Traces⁵
 - Drive Performance
 - Drive Firmware Update
 - Drive *n*
 - Add¹
 - Remove¹
 - Replace¹
 - Clean
 - Detail
 - DLM Report
 - Test
 - Reset
- Controllers (A, S)
 - Controllers
 - Add¹
 - Remove¹
 - Replace¹
 - Failover
- System (A, S)
 - System Setup—Option Enablement
 - Hardware ID
 - Key
 - Save
 - Currently Installed Keys
- Go to Configuration (Cont.)

Configuration (Cont.)

- System (Cont.) (A, S)
 - System Setup—Other Settings
 - Library Name
 - Web Server Port
 - Refresh Rate
 - Auto Logout Timeout
 - Online Access to Spectra Logic
 - Drive Performance Monitoring
 - Power Consumption Monitoring
 - Enable Automatic Power-Up After Power Failure
 - Enable SSL
 - Enable SNMP Agent
 - SNMP Settings
 - Enable Soft Power
 - Syslog Server IP Address
 - BlueScale Vision IP Address
 - Network Settings
 - Mail Users
 - Auto Configuration Save
 - Routine Maintenance
 - Date and Time
 - Media Lifecycle Management (A, S)
 - Media Lifecycle Management Settings
 - Enable MLM
 - Enable Alerts for Non-MLM Media
 - Enable Alerts for Load Count Discrepancies
 - Minimum Cleaning Passes Before Warning
 - Maximum Tape Loads Before Warning
 - Enable Media Auto Discovery
 - Minimum Idle Minutes Before Auto Discovery
 - Convert to Broadcast Hours
 - Override Broadcast Bit Rate
 - PostScan Blackout Periods

Maintenance

- Package Update (A, S)
 - Begin Library Update
 - Begin Drive Update
 - Manage Packages
 - Manage Package Servers
 - Auto Download Options
- Tools (A, S)
 - Utilities
 - Basic Utilities List
 - Upload Backup Configuration
 - Advanced Utilities List⁴
 - Save MLM Database
 - Restore MLM Database
 - HHM: View Data
 - EtherLib Status
 - Traces
 - System Traces
 - Component Traces
- Diagnostics (A, S)
 - Motion Diagnostics
 - Motion Diagnostics List
 - Previous Results
- Go to Maintenance (Cont.)

Maintenance (Cont.)

- AutoSupport (A, S)
 - Send Log Set
 - Select Profile to Send Log Set
 - Select Ticket Type
 - Profile Summary
 - Confirm and Submit Ticket
 - Manage Profiles
 - New Profile
 - Remove
 - Edit Profile
 - Configure Alarms
 - Log Forwarding
- Media Lifecycle Management
 - Media Lifecycle Management Tools
 - Discover Media
 - Select Partition
 - Stop Discovery (only visible when Discover Media is running)
 - Pause PostScan (only visible when PostScan is running)
 - Manual PostScan
 - Delete MLM Records
 - Download MLM Database (remote access only)
 - Download DLM Database (remote access only)

Security

- Switch User (O, A, S)
 - Library Controller: Login
- Edit Users (A, S)
 - Library Users
 - Users
 - Delete
 - Edit
 - Add/Update User
 - User
 - Password
 - User Type
- Encryption (S)
 - Encryption User Login
 - Encryption Configuration
 - Configure
 - Single User Mode
 - Multi-User Mode (BlueScale Encryption Pro only)³
 - Spectra SKLM^{3,7}
 - KMIP^{3,6}
 - Check Key Files
 - Import Key
 - Add Key
 - Moniker
 - Export Key
 - Delete Key

Status Bar

- Refresh
- HHM Notification (when maintenance threshold is reached)
 - Send AutoSupport Ticket > Send Log Set
- System Status
 - System Messages
- Remote Support
 - BlueScale Vision Camera (when enabled)
 - Last Refresh (time and date)
 - BlueScale Software Version
 - Library IP Address (local access)
 - OR—
 - Library Name (remote access)

Notes:

- Available at the library's front panel touch screen only.
- Requires LTO-4 or later generation Fibre Channel drives.
- Only available with a purchased key.
- Do not use any Advanced Utilities except those listed here unless instructed to do so by SpectraGuard® Support.
- Requires LTO-5 or later generation Fibre Channel drives.
- Requires LTO-6 or later generation Fibre Channel drives.
- Requires LTO-5 or later generation Fibre Channel or TS11x0 Technology drives.

Library user types: *Superuser*, *Administrator*, and *Operator*

Feature Availability: This feature is available to this user type:

S) *Superuser* – Controls all aspects of library use, configuration, and security.

A) *Administrator* – Performs all actions except creating or editing library users, and accessing encryption.

O) *Operator* – Moves, imports, and exports media.

Note: The BlueScale user interface changes as features are added or modified. Check *Spectra T950V Library BlueScale Toolbar Option Map* for the latest version of this option map.

Figure 28 Map of the options available from the BlueScale Toolbar.

Status Bar

The status bar is located along the bottom edge of most screens. The information and icons displayed on the status bar depend on the status of the system and whether you are using the operator panel or the BlueScale web interface.

Note: See [Additional Status Bar Icons on page 79](#) for additional icons that can also appear on the status bar.

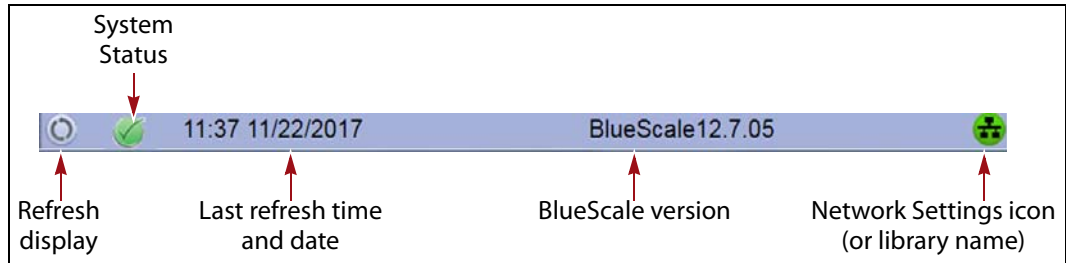

Figure 29 The BlueScale status bar.

Refresh Display Button Refreshes (updates) the information currently displayed on the user interface. If you set a long interval for the refresh rate or disabled the automatic screen refresh by setting the refresh rate to zero (see [Refresh Rate on page 100](#)), you can refresh the screen manually by clicking the refresh display button.



Important

Do not use keyboard commands (for example, **F5**) to refresh the browser when connected to the BlueScale web interface. These keyboard commands can cause unpredictable results.

System Status Icon Indicates the status of library components. The BlueScale user interface uses the following icons to indicate the status of library components. Click the status icon to view system messages (see [Check and Respond to Messages on page 146](#) for information about these messages).

Note: These status icons also display next to the major system components shown on the General Status screen (see [Figure 27 on page 73](#)).

Icon	Description	Meaning
	A check mark (✓) in a green circle	All system components are functioning correctly.
	An <i>i</i> in a blue circle	An informational message about a system component is available. Check messages to determine the component.
	An exclamation point (!) in a yellow triangle	A system component requires attention. Check messages to determine the component.
	An X in a red circle	A system component experienced an error condition. Check messages to determine the component.

Last Refresh Time and Date Shows when the displayed information was last updated. The library refreshes different screens at different rates, depending on the type of data displayed. The screen refresh rate can be set for a specific interval or disabled (see [Refresh Rate on page 100](#)). The displayed information can be refreshed manually by clicking the refresh display button.

BlueScale Version Shows the BlueScale software version currently being used by the library.

Network Settings Icon or Library Name Shows the Network Settings icon or name for the library. If you are managing the library from the touch screen operator panel, the Network Settings icon displays on the status bar. Click the icon to go to the Network Settings screen. If you are using the BlueScale web interface, the library's name is shown instead of the Network Settings icon.

Note: If you are using the BlueScale web interface and you did not set the library name, the right-hand side of the status bar is blank.

If you need to view or set the library's IP address or name, see [Configure Network Settings on page 104](#) and [Library Name on page 100](#), respectively.

Additional Status Bar Icons

The status bar can also include the following additional icons.

Auto Download Icon If one or more package servers are configured to automatically download firmware packages (see [Configure a Package Server on page 129](#)) and a new package was downloaded, the Auto Download icon (a wrench in a yellow circle) displays to indicate that an update package is ready for installation. Click the icon to navigate to the Package Update screen. See [Updating the BlueScale Software and Library Firmware on page 388](#) and [Updating Drive Firmware on page 419](#) for information on installing the update.



Figure 30 The Auto Download icon in the BlueScale status bar.

Remote Support Icon Provides you with online access to the support section of the Spectra Logic website where you can search the Knowledge Base, access the Product Documentation, and download BlueScale update packages and drivers. If you need additional assistance, contact Spectra Logic Technical Support (see [Contacting Spectra Logic on page 7](#)).



Figure 31 The Remote Support icon in the BlueScale status bar.

The remote support icon is also used to activate secure remote access capabilities using Cisco® WebEx® technology. This remote access helps Spectra Logic Technical Support provide faster resolution of support calls. This capability is only enabled on an as-needed basis during a support call.

- Notes:**
- The remote support icon is only visible when you are accessing the library through the BlueScale web interface.
 - When Spectra Logic Technical Support needs to launch a WebEx session to access your library, they send you a link via email.

HHM Icon When the library or one of its components reaches its maintenance threshold, the Hardware Health Monitor (HHM) notification icon appears on the status bar. As with the system message icon, the color of the icon indicates the urgency of the notification.

You can click the icon to view information about the notification and send a Hardware Health Monitor ticket to a contact person within your organization or to Spectra Logic Technical Support. They can then review the logs and determine if any maintenance tasks are needed (see [Using BlueScale Hardware Health Monitoring on page 324](#)).

Note: The HHM icon only displays if an HHM threshold is reached. After any required tasks are complete, the threshold can be reset. The HHM icon disappears until the next threshold is reached.

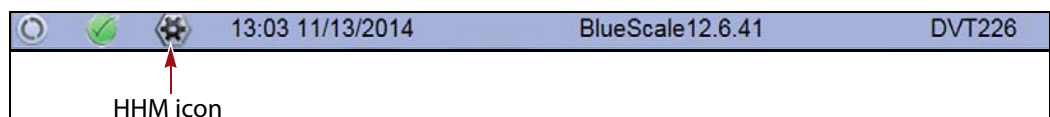

Figure 32 The HHM icon in the BlueScale status bar.

Progress Bar

When the library is busy processing a command, a horizontal progress bar displays above the status bar. Do not use the touch screen (or the BlueScale web interface) until the progress bar disappears.

Library Management

The library management features in the BlueScale user interface provide maximum configurability and ease of use for the T950V library. To take full advantage of the library's versatility, read the following overview of the library's management features.

Automatic Email Alerts

Simple Mail Transfer Protocol (SMTP) lets users receive library status information via email. When the library generates messages through the library controller, it automatically sends email notifications to users who are configured to receive them. Information included in the notification consists of the message number, severity, details, remedy, and the time it was generated. Message types are Information, Error, Warning, and Fatal (see [System Messages on page 145](#)). You can select the types of messages each library user receives (see [Configure Mail Users on page 106](#)).

AutoSupport

AutoSupport guides you through the process of sending email regarding library problems — along with library logs and configuration information — directly to internal support personnel or Spectra Logic Technical Support. See [Chapter 11 – Configuring and Using AutoSupport, beginning on page 297](#) for detailed information.

Online Access to Spectra Logic

When the library is set up with access to the Internet, the bottom portion of the user interface web page displays technical tips, allows one-click access to Spectra Logic's Knowledge Base, streamlines the online ordering of media and capacity, and more. Online access can be enabled or disabled during any browser session (see [Disable Online Access to Spectra Logic on page 101](#)). The setting of online access to Spectra Logic does not affect AutoSupport.

User Security

Library users are assigned to one of three groups, each with its own set of pre-defined library privileges (also known as permissions). These privileges determine the type of operations a user can perform on the library and are the primary means for configuring library security. See [Configuring Library Users on page 90](#) for detailed information about users.

Note: An additional, separate password must be entered to access the encryption features. See the *Spectra Tape Libraries Encryption User Guide* for information about the encryption user.

USING THE BLUESCALE USER INTERFACE

The library's BlueScale user interface lets you set configuration options, view library and drive information and metrics, manage media, and monitor library operations.

Note: Unless otherwise specified, references to the user interface screens apply to both the touch screen on the library operator panel and the screens presented through the BlueScale web interface.

Log Into the User Interface

Before you can manage or configure the library, you must log into the BlueScale user interface.

After the library completes its power-on sequence, the Library Initialization screen displays. This screen lists the required initialization steps and current status of the library's major components (Robotics, RCM, and LCM). Text boxes provide descriptions about the currently active tasks.

- Notes:**
- If your library has a static IP address, you can access the library using the BlueScale web interface (RLC) as soon as the Library Initialization screen displays
 - If the library cannot complete the initialization process, it generates system messages and enters maintenance mode. Contact Spectra Logic Technical Support for assistance.

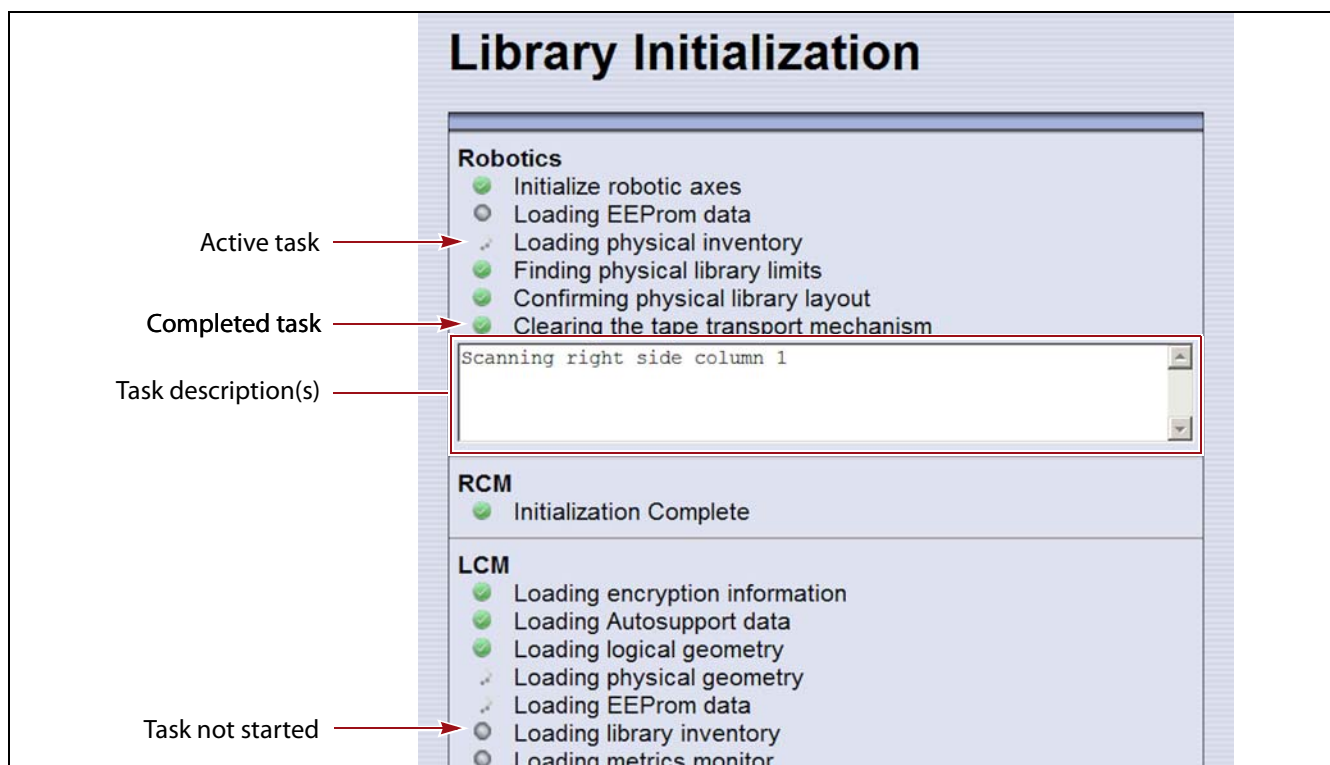

Figure 33 The Library Initialization screen.

After the library completes initialization of configured components, the Library Controller: Login screen displays on the library operator panel. This Login screen also displays when you access the library remotely using the BlueScale web interface (RLC), as well as when you switch users or when the library automatically logs out the current user if auto-logout is enabled.

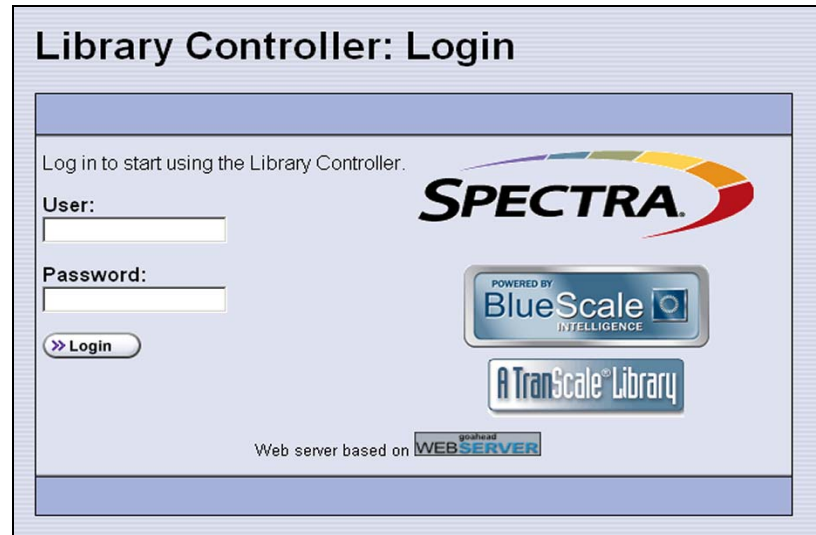

Figure 34 The Library Controller: Login screen.

If there is no interaction with the operator panel within 30 seconds after the Login screen displays, the Login screen is replaced by the pre-login General Status screen. This General Status screen provides at-a-glance status for the library and its components without requiring you to log into the library. You can view the status of the entire library or a specific partition.

Note: The pre-login General Status screen does not display when you access the library remotely through the BlueScale web interface.

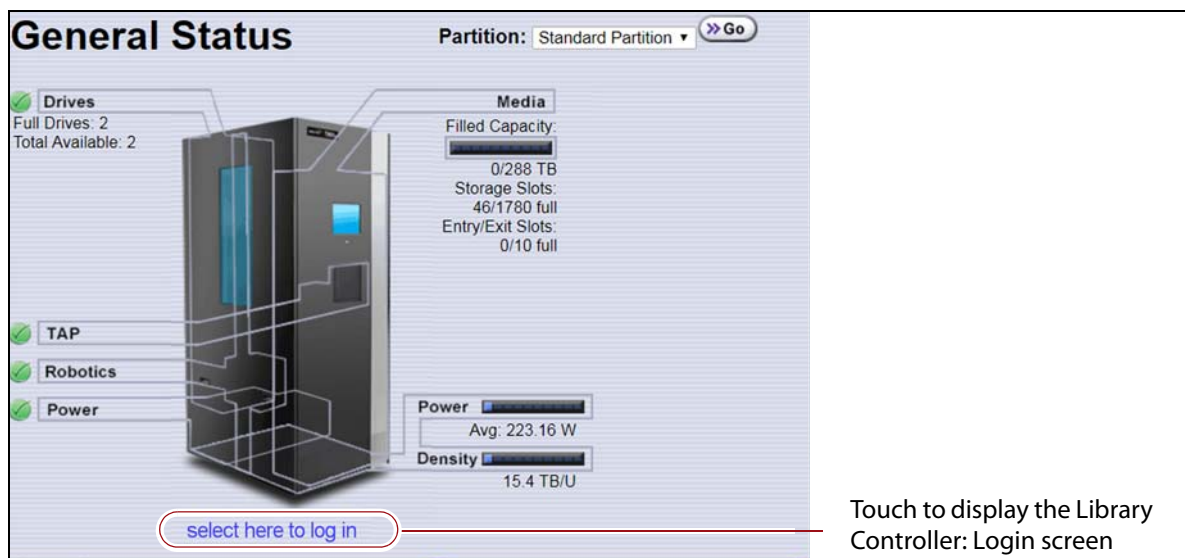

Figure 35 Log in from the pre-login General Status screen.

Use the following steps to log into the library:

1. Connect to the library. The method depends on how you are accessing the library.

Using the front panel touch screen or a direct connection to the LCM

- If the Login screen is displayed, skip to [Step 2 on page 85](#).
- If the pre-login General Status screen is displayed, touch or click **select here to login** at the bottom of the screen to display the Login screen and then skip to [Step 2 on page 85](#).

Note: If the soft keyboard is open and covering the bottom of the pre-login General Status screen, touch the keyboard icon to close the soft keyboard or use the scroll bar on the right side of the screen to scroll down to the bottom of the screen.

Connecting to the library remotely using the BlueScale web interface

Enter the IP address of the T950V library in the address bar of a web browser on a computer on an active network that has access to the library. The steps you use depend on whether SSL is enabled or not.

If SSL is...	Use the following steps...
Not enabled (the default setting)	<ol style="list-style-type: none"> 1. Enter the IPv4 or IPv6 address configured for the library in the format: http://[library IP address] (see Configure Network Settings on page 104). 2. The BlueScale Login screen displays (see Figure 34 on page 83). Proceed to Step 2 on page 85.
Enabled	<ol style="list-style-type: none"> 1. Enter the IPv4 or IPv6 address configured for the library in the format https://[library IP address] See Enable SSL on page 102 for information about enabling SSL.  Important: When using SSL, you must prefix the IP address with https:// instead of just entering the IP address. 2. If you receive a warning about the website's security certificate, choose to ignore or resolve the warning. Notes: <ul style="list-style-type: none"> ▪ The security warning only appears if you did not resolve the security certificate warning, either by storing a valid security certificate on the library (see Install a Security Certificate and Authentication Key on page 112) or by creating a security exception for the library on the browser (method depends on the browser you are using). ▪ If you do not resolve the warning, you receive the warning about the security certificate each time you access the BlueScale web interface. 3. The BlueScale Login screen displays (see Figure 34 on page 83). Proceed to Step 2 on page 85.

2. Select the **User** text box. A cursor appears in the box.

Note: When using the touch screen on the library operator panel, touch the keyboard icon on the Login screen to activate the soft keyboard on the library's touch screen. Use the stylus or your finger to select fields and to type information using the soft keyboard.

Touching the keyboard icon again closes the soft keyboard.

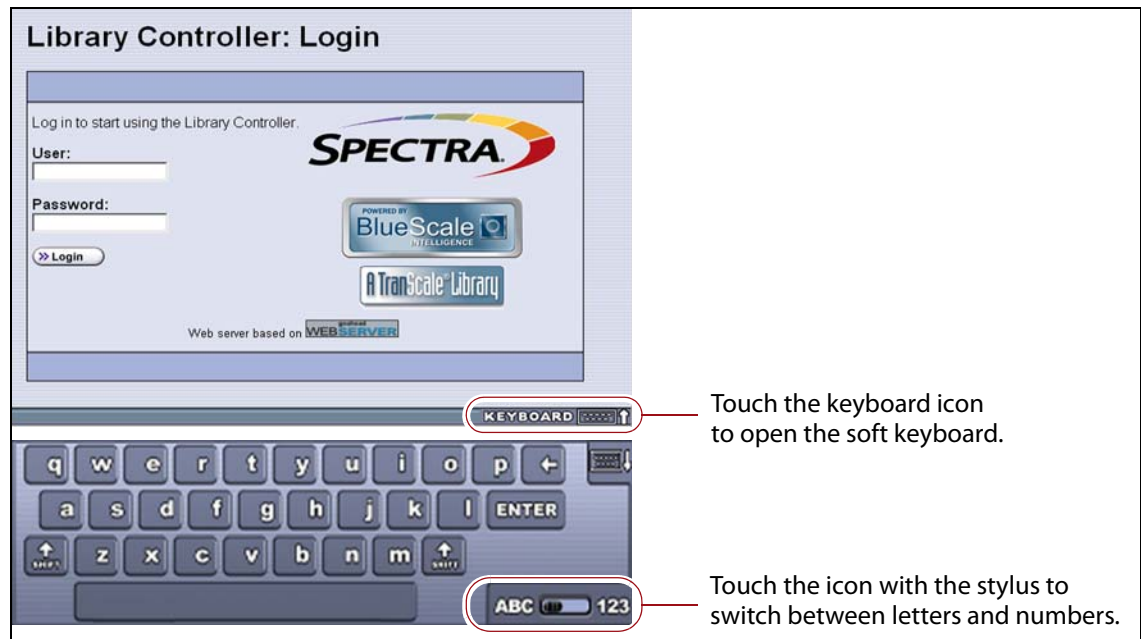

Figure 36 Log into the library using the Library Controller: Login screen.

3. Type your user name (**su** is the default user name for a superuser).
See [Understanding User Groups and Security on page 90](#) for information about the three types of user groups and the options and controls accessible to each user group.
4. Type your password in the **Password** text box. If you log in as one of the default users, there is no password (unless you configured one).

Note: By default, passwords are not required to log into the library. If you want to password-protect access to the library, set passwords for each user as described in [Configuring Library Users on page 90](#).

5. Click **Login**. The library's General Status screen displays.

Note: If you just powered-on or reset the library, there may be a delay after you click **Login** while the library completes its initialization. When the initialization is complete, the General Status screen displays.

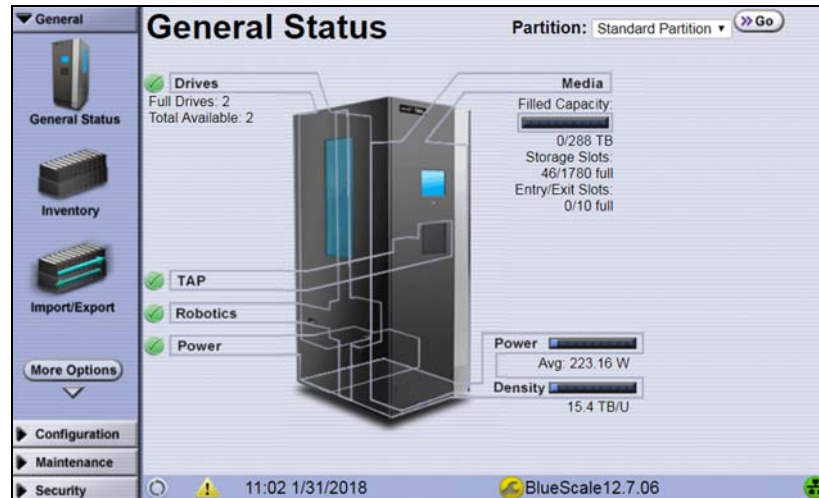

Figure 37 The BlueScale user interface General Status screen.

6. If you want to enable encryption or configure encryption settings or keys, select **Security** > **Encryption** to log into the Encryption feature (see the *Spectra Tape Libraries Encryption User Guide* for detailed instructions).

Log Off or Switch Users

1. If a screen other than the Login screen is displayed, select the **Security** toolbar to display the Security options.

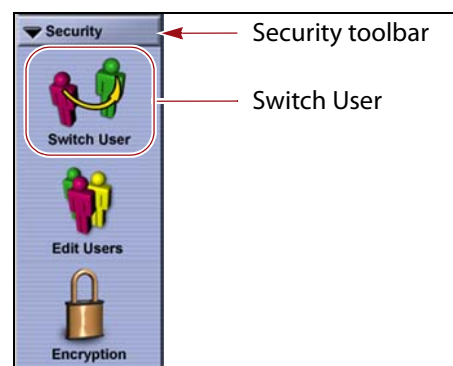

Figure 38 The Security toolbar.

2. Select **Switch User** to log out the currently logged in user and redisplay the Login screen.
3. If desired, log in again using the same or a different user name and password.

Enter Information on Screens

Entering information on a user interface screen requires using one of the following methods.

BlueScale Web Interface

The BlueScale web interface lets you use your computer keyboard to enter information into the user interface and a mouse to navigate through the user interface screens (see [BlueScale Web Interface on page 72](#)). Using the web interface is the most convenient way to enter large amounts of information when you are configuring the library.



Important

When accessing the library remotely through a web browser, do not use the **Enter** key on your keyboard when making selections in the BlueScale user interface. Various web browsers handle the **Enter** key differently, causing inconsistent behavior in the BlueScale interface.

Always use your mouse to make selections and click the buttons in BlueScale screens instead of using your keyboard.

Note: Functions that require physical interaction with the library (for example, importing or exporting magazines) are not available when using the BlueScale web interface.

Soft Keyboard

When using the touch screen on the operator panel, select the keyboard icon in the lower right corner of any screen to activate the on-screen keyboard. When the keyboard is extended, an icon in the lower right corner lets you select between alphabetic or numeric characters. Use a stylus or your finger to select fields and enter alphanumeric information using the keyboard. Touching the keyboard icon again closes the keyboard.



Note: The soft keyboard can also be used to access several troubleshooting features provided through the BlueScale software (see [Troubleshooting BlueScale User Interface Issues on page 316](#)).

External Keyboard and Mouse

If you cannot use the BlueScale web interface, using a USA-type USB keyboard and USB mouse connected to the library LCM (see [Figure 9 on page 39](#)) is useful when you need to enter large amounts of information. The user interface options available when you use an external keyboard and mouse are the same as when you use the library's touch screen operator panel.



Important

Not all characters on a USA-type keyboard are supported in the BlueScale user interface. If a character does not appear on the soft keyboard, then its use is not supported.

When accessing the library using an external keyboard connected to the library, do not use the **Enter** key on your keyboard when making selections in the BlueScale user interface. Doing so may cause inconsistent behavior in the BlueScale interface.

- Notes:**
- If using a non-USA type keyboard, you need to find the equivalent for some characters like the back slash or forward slash.
 - When using a keyboard and mouse connected directly to the library, it may also be useful to connect a monitor to the monitor port on the LCM. The monitor displays the same information as the touch screen.

Feedback Required Screens

When the BlueScale software needs you to make a selection or perform an action it displays a Feedback Required screen. If you do not respond to the Feedback Required screen within 10 minutes, the request times out and the action fails.

CHAPTER 4

Configuring the Library

When it was installed, your library was configured according to your initial requirements. This chapter describes the procedures for configuring the library's system settings, including the users, the network connections, and optional features.

Note: For instructions on how to operate the library, see:

- Chapter 5 – Operating the Library, beginning on page 140
- Chapter 6 – Configuring and Managing Partitions, beginning on page 159
- Chapter 9 – Configuring and Using Media Lifecycle Management, beginning on page 243
- Chapter 10 – Using Drive Lifecycle Management, beginning on page 288
- Chapter 11 – Configuring and Using AutoSupport, beginning on page 297

Topic	
Configuring Library Users	page 90
Understanding User Groups and Security	page 90
Add a New User	page 91
Modify an Existing User	page 93
Delete an Existing User	page 93
Accessing the System Setup Screen	page 93
Enabling BlueScale Software Support, Options, and Upgrades	page 95
Enter Activation Keys	page 97
Add Options	page 98
Configuring the Global System Settings	page 99
Configure the System Settings	page 100
Configure Network Settings	page 104
Configure Mail Users	page 106
Enable Email for the Auto Configuration Save File	page 108
Set the Date and Time	page 110

Topic	
Configuring Optional Library Settings	page 111
Install a Security Certificate and Authentication Key	page 112
Configure Routine Maintenance	page 115
Enable and Configure SNMP	page 116
Configure Controller Failover	page 119
Configure Emulation	page 122
Configure Barcode Reporting	page 124
Configure a Package Server	page 129
Configure Rotation Manager	page 133
Backing Up the Library Configuration	page 135
Use Automatic Backup of the Library Configuration	page 136
Use Manual Backup of the Library Configuration	page 136

CONFIGURING LIBRARY USERS

Overview Each library user is assigned to one of three user groups, each with its own set of pre-defined library privileges (also known as permissions).

User Privilege Requirements Only a user with superuser privileges can add, modify, or delete users.

Understanding User Groups and Security

Before you begin, read this section to understand the three types of user groups and what types of privileges each has.

Note: You must enter an additional password to access the encryption features. See the *Spectra Tape Libraries Encryption User Guide* for information about the encryption user.

The following table describes the three user groups and the privileges of each. By default, passwords are not required for any of the three default users.

User Group Type	Description	Default User Name
Superuser	<p>Controls all aspects of the library's configuration and operation, including defining other library users and assigning them to a user-privilege group.</p> <p>Notes:</p> <ul style="list-style-type: none"> ▪ The library requires a minimum of one superuser. You cannot delete the last member of the Superuser group. ▪ Only a user with superuser privileges can add, modify, or delete users. ▪ Only a user with superuser privileges can access and configure encryption features. ▪ Only a user with superuser privileges can use the Soft Power feature. ▪ Only a user with superuser privileges can enable or disable the Enable Automatic Power-Up After Power Failure feature. 	su
Administrator	<p>Configures and uses the library. With the exception of creating or modifying library users, accessing the encryption features, enabling Automatic Power-Up After Power Failure, and using the Soft Power feature, users in the Administrator group have the same privileges as users in the Superuser group.</p>	administrator
Operator	<p>Performs day-to-day operations. Users assigned to the Operator group can move, import, and export media, but cannot access the more sensitive library operations such as configuration, diagnostics, and security.</p>	operator

Add a New User

Use the following steps to add a new library user and assign that user to a user group.

1. Log into the library as a user with superuser privileges (see [Log Into the User Interface](#) on page 82).

- From the toolbar menu, select **Security** > **Edit Users**. The Library Users screen displays.

Figure 39 The Library Users screen.

- Complete the information in the Add/Update User panel.

Note: User names and passwords can contain any combination of the numbers 0-9, lower and upper case alphabetic characters (a-z and A-Z), and the at symbol (@), dash (-), underscore (_), period (.), forward slash (/), and space characters. There is no limit to the length but Spectra Logic recommends lengths of less than 2048 characters.

For this field...	Enter...
User	The username for the user.
Password Retype Password	A password for the user and then retype the password to confirm. Notes: <ul style="list-style-type: none"> For security, the text in the Password and Retype Password fields is shown as asterisks (*). Though highly recommended, passwords are not required for any of the three user types.
User Type	Select the group to which the user belongs. Note: See Understanding User Groups and Security on page 90 for descriptions of the user groups and privileges associated with each.

- Click **Save**. The new user name and group assignment is added to the list of users.
- Repeat [Step 3](#) and [Step 4](#) for each additional library user.

Modify an Existing User



Important

If you change the passwords for the default users, make sure that you keep a record of the new passwords. The passwords cannot be reset if you forget them.

Use the following steps to change settings for an existing user.

1. Log into the library as a user with superuser privileges.
2. From the toolbar menu, select **Security**  **Edit Users**. The Library Users screen displays (see [Figure 39 on page 92](#)), showing a list of library user names.
3. Find the user's name, then click **Edit** next to the name.
4. Change the user's name, password, group, or any combination of these as required.
5. Click **Save** to save your changes.

Delete an Existing User

Use the following steps to delete an existing user.



Important

If you delete the default users, make sure that you keep a record of at least one superuser name and password.

Note: The library requires there to be a minimum of one user assigned to the superuser group. You cannot delete the last member of the superuser group.

1. Log into the library as a user with superuser privileges.
2. From the toolbar menu, select **Security**  **Edit Users**. The Library Users screen displays (see [Figure 39 on page 92](#)), showing a list of library user names.
3. Locate the name of the user to delete, then click **Delete** next to that user's name.

When the screen refreshes, the user list no longer includes the user name you just deleted.

ACCESSING THE SYSTEM SETUP SCREEN

Overview All of the settings for the library's general configuration options are accessed through the System Setup screen. The screen is divided into two panes. You may need to use the scroll bar to see the entire screen.

- **Option Enablement pane** — Used for entering the activation keys for any purchased options, including BlueScale Software Support, licensed capacity (chambers), and Shared Library Services (SLS). This panel also lists all of the currently licensed options.

System Setup

Option Enablement

You can purchase additional options for your library. Contact Spectra Logic with the hardware ID shown below to obtain an activation key.

Hardware ID: 0918401

Key:

Currently installed keys and library capacity are listed below.

Key	Description
34BFJQVXZ6K44FZ	Capacity License: 100 Chambers
3DBVQ3RVZAA7Z7Z	Encryption Pro License: Enabled
DHJDRTH65BLTT25	BlueScale Software Support License: Package Update Enabled

Chambers currently licensed: 100

Figure 40 The System Setup Option Enablement pane.

- **Other Settings pane** — Used for configuring the operational parameters for the library.

Other Settings

Library Name: DVT226

Web Server Port: 80

Refresh: 60 seconds

Auto Logout Timeout: 0 Minutes

Disable Online Access to Spectra Logic

Enable Drive Performance Monitoring

Enable Power Consumption Monitoring

Enable Automatic Power-Up After Power Failure

Enable SSL

Enable SNMP Agent

Enable Soft Power

Syslog Server IP Address: 0.0.0.0

Network Settings:

Mail Users:

Auto Configuration Save:

Routine Maintenance:

Date And Time:

Figure 41 The Other Settings pane of the System Setup screen.

User Privilege Requirements Only a user with superuser or administrator privileges can access the System Setup screens to enable new options or change system configuration settings. See [Configuring Library Users on page 90](#) for information about the three types of user groups and what types of privileges each has.

Access the System Setup Screen Use the following steps to access the System Setup screen when you want to enable a new option or change a configuration setting.

1. Log into the library as a user with superuser or administrator privileges (see [Log Into the User Interface on page 82](#)).
2. From the toolbar menu, select **Configuration**  **System**. The System Setup screen displays ([Figure 40](#) and [Figure 41](#) show the two panes of the screen).

ENABLING BLUESCALE SOFTWARE SUPPORT, OPTIONS, AND UPGRADES

Overview Activation keys are required to enable the BlueScale Software Support license and any library options and upgrades you purchase. These activation keys are tied to the library serial number (the hardware ID). The library ships with paper copies of the activation keys for the initial BlueScale Software Support license, the initial licensed slot capacity, and any additional options you purchased with the library. You must enter the activation key for the BlueScale Software Support license and each option into the library to make the option available for use.

Requirements for updating the library BlueScale software A valid BlueScale Software Support key is required in order to update the library's BlueScale software and component firmware. When you renew or extend your service contract, you receive an activation key that must be entered into the System Configuration screen to enable continued BlueScale updates.



Important

Your initial library purchase includes a BlueScale Software Support key that is valid for the duration of the warranty period, or for the duration of any uplifted or extended service contract you purchased with the library, whichever is longer. When you renew or extend your service contract, you must generate a new BlueScale Software Support key and enter the new key into the library to allow continued access to BlueScale upgrades (see [Obtain the Option Activation Key on page 99](#)). If you have questions about your service agreement, contact Spectra Logic Technical Support (see [Contacting Spectra Logic on page 7](#)).

Standard and upgraded options for the library The default library configuration includes a basic set of options that lets you start using the library immediately. These options do not require activation keys to enable them. When you purchase upgraded options or additional Capacity on Demand (CoD), you receive an activation key that must be entered into the System Configuration screen to enable the options. See [Library Support and Upgrades on page 468](#) for information about the available upgrade options.

Option	The default library configuration includes...	Upgrade if you need...
Partitions	Support for using a single storage partition.	Additional storage partitions. Purchase a Shared Library Services (SLS) activation key. See Library Partitions on page 50 for information about how SLS provides partitioning in the library.
Encryption	BlueScale Encryption Standard Edition.	More advanced encryption management capabilities. Purchase either BlueScale Encryption Professional Edition, the Spectra SKLM encryption key management system, or the KMIP encryption key management system using HPE ESKM. See the <i>Spectra Tape Libraries Encryption User Guide</i> for information.
CoD Capacity	The licenced number of chambers you purchased with the library. Notes: <ul style="list-style-type: none"> ▪ Each chamber accommodates one TeraPack magazine. Each magazine contains ten slots for LTO media or nine slots for TS11xx technology media. ▪ The licensed chambers must be enabled by entering the activation key into the System Configuration screen (see Enter Activation Keys on page 97). 	Additional capacity. Purchase a CoD activation key for the additional chambers you need. See Library Support and Upgrades on page 468 for more information. Notes: <ul style="list-style-type: none"> ▪ You must create or modify a partition to make use of the added capacity. See Chapter 6 – Configuring and Managing Partitions, beginning on page 159 for instructions. ▪ If the CoD capacity you purchase exceeds the number of chambers that are present in the library, the extra licensed chambers cannot be used unless you also purchase shelves to replace a DBA in an existing frame or an expansion frame.

Enter Activation Keys

- Notes:**
- Paper copies of the activation keys for the initial BlueScale Software Support license and the options you purchased with the library are included with the library when shipped.
 - The activation keys for the initial BlueScale Software Support license and the options you purchased with the library are entered during the installation of the library. Compare the paper copies of the activation keys with information in the Option Enablement pane of the System Setup screen and enter any missing keys as described in this section.
 - If you purchase options after the initial library installation, you are provided an activation key for each option as described in [Add Options on page 98](#).
 - If you receive activation keys by email, it is helpful to use the BlueScale web interface (RLC) to access the System Setup screen. You can then cut and paste keys from the email containing the keys into the System Setup screen instead of typing them.

Use the following steps to enter a new BlueScale Software Support key or the activation key for a new option into the library.

1. Have on hand the activation key for the BlueScale Software Support license or other option (see [Obtain the Option Activation Key on page 99](#)).
2. Access the System Setup screen (see [Accessing the System Setup Screen on page 93](#)).

The Option Enablement pane at the top of the screen lists the currently licensed options.



Figure 42 Enter the keys in the Option Enablement pane of the System Setup screen.

3. Enter the activation key for the option you want to enable in the **Key** field.

Note: The activation keys are not case-sensitive.

4. Click **Save**. The System Setup screen refreshes and displays the new activation key and its description in the list of keys. The option is available for immediate use.

Note: Keep a record of all activation keys listed on the Option Enablement pane of the System Setup screen. You need to re-enter them if the library is reset to factory defaults.

Add Options

This section describes how to determine the Hardware ID and obtain activation keys for new options *after* the initial installation. See [Renewing the BlueScale Software Support Key on page 386](#) if you need to renew or extend your service contract, which includes the BlueScale Software Support key.

Important

The BlueScale Software Support key and all option activation keys are tied to the library serial number. If you have multiple libraries, you need separate activation keys for each library.

Determine the Library Serial Number

The library serial number (Hardware ID) is required for renewing or extending your service contract, which includes the BlueScale Software Support key, and for purchasing additional Capacity on Demand (CoD) or other upgrade options.

Use the following steps to determine your library's serial number.

1. Access the System Setup screen (see [Accessing the System Setup Screen on page 93](#)).
2. Make a note of the library's serial number (Hardware ID), which is needed to generate the activation keys.



Figure 43 Locate the library's serial number (Hardware ID).

Obtain the Option Activation Key

1. Contact your Spectra Logic sales representative to order the desired options (see [Contacting Spectra Logic on page 7](#)).
2. When your order is processed, the Spectra Logic Customer Care team contacts you with instructions for generating the activation key for each option.
3. Enter each activation key into the Option Enablement pane of the System Setup screen (see [Enter Activation Keys on page 97](#)).

CONFIGURING THE GLOBAL SYSTEM SETTINGS

This section describes how to modify the library's general configuration settings. To change the current value for any of these settings, access the System Setup screen (see [Accessing the System Setup Screen on page 93](#)), then scroll down to the Other Settings pane. The following sections describe using this screen to configure the library.

The screenshot shows the 'Other Settings' pane of the System Setup screen. It contains the following settings:

- Library Name: DVT226 [Save]
- Web Server Port: 80 [Save]
- Refresh: 60 seconds [Save]
- Auto Logout Timeout: 0 Minutes [Save]
- Disable Online Access to Spectra Logic [Save]
- Enable Drive Performance Monitoring [Save]
- Enable Power Consumption Monitoring [Save]
- Enable Automatic Power-Up After Power Failure [Save]
- Enable SSL [Save]
- Enable SNMP Agent [Save]
- Enable Soft Power [Save]
- Syslog Server IP Address: 0.0.0.0 [Save]
- Network Settings: [Edit]
- Mail Users: [Edit]
- Auto Configuration Save: [Edit]
- Routine Maintenance: [Edit]
- Date And Time: [Edit]

Figure 44 The Other Settings pane of the System Setup screen.

Configure the System Settings

The following table lists the system settings that are configured through the Other Settings pane of the System Setup screen, describes how to change each setting, and provides the default value for each setting, if applicable.

Setting	Description	Default
Library Name	<p>Set the name used to identify the library in messages it sends to mail recipients.</p> <ol style="list-style-type: none"> 1. Type a name for the library. Use a name that helps identify the library to a remote user. 2. Click Save. 	blank (no name set)
Web Server Port	<p>Set the port number for the dedicated Ethernet port used to access the library's embedded web server.</p> <ol style="list-style-type: none"> 1. Enter a port number from 0 to 65,535. The default port number is 80, which is appropriate for most installations and is strongly recommended. If you use a port number other than 80, the port number must be explicitly entered into the web browser when accessing the library remotely. <p> Important: Do not set the web server port to 443. Using this port number causes the front panel display to become unstable.</p> <ol style="list-style-type: none"> 2. Click Save. 3. Reset the library to enable the new web port number setting (see Resetting the Library on page 333). 	80
Refresh Rate	<p>Set how frequently the information on the BlueScale user interface screens is refreshed.</p> <ol style="list-style-type: none"> 1. Use the Refresh drop-down list to select a scheduled interval time. 2. Click Save. <p>Notes:</p> <ul style="list-style-type: none"> ▪ You can manually refresh the displayed information at any time by clicking the refresh display button located at the left end of the status bar (see Status Bar on page 78). ▪ If you want to disable automatic refreshing of the display, set the refresh rate to off. ▪ If you configure a setting other than the default refresh rate or disable automatic refreshing, you must configure the refresh rate every time you log into the library. 	60 seconds

Setting	Description	Default
Auto Logout Timeout	<p>Set how long the current connection to the BlueScale user interface is idle before the current user is logged out.</p> <ol style="list-style-type: none"> 1. Enter the number of minutes for the timeout. 2. Click Save. <p>Note: Setting the timeout value to zero disables auto logout.</p>	0 (zero) minutes (Disabled)
Disable Online Access to Spectra Logic	<p>Disable or enable displaying links to the Spectra Logic website at the bottom of each BlueScale screen when the library has a connection to the Internet.</p> <ol style="list-style-type: none"> 1. Select the Disable Online Access to Spectra Logic check box to disable the option (or clear the check box to enable it). 2. Click Save. 	Cleared (Enabled)
Enable Drive Performance Monitoring	<p>Enable or disable the option to monitor the performance of the drives in the library (see View Drive Performance Statistics on page 149).</p> <p> CAUTION: Make sure that the drives do not contain media before you enable or disable Drive Performance Monitoring. If you enable or disable this option when a drive contains a cartridge, the drive is reported as empty and backups may fail.</p> <ol style="list-style-type: none"> 1. Select the Enable Drive Performance Monitoring check box to enable the option (or clear the check box to disable it). 2. Click Save. 	Cleared (Disabled)
Enable Power Consumption Monitoring	<p>Enable or disable the option to monitor the amount of power your library is using through the Power Consumption Monitor (EnergyAudit) feature (see View Power Consumption Statistics on page 151).</p> <ol style="list-style-type: none"> 1. Select the Enable Power Consumption Monitoring check box to enable the option (or clear the check box to disable it). 2. Click Save. <p>Note: When you disable and then re-enable power consumption monitoring, the library does not begin capturing data again until you power cycle the library.</p>	Selected (Enabled)
Enable Automatic Power-Up After Power Failure	<p>Enable or disable the option to automatically power on the library after a power failure (see Use the Automatic Power-Up After Power Failure Feature on page 142).</p> <ol style="list-style-type: none"> 1. Select the Enable Automatic Power-Up After Power Failure check box to enable the option (or clear the check box to disable it). 2. Click Save. <p>Note: The Enable Automatic Power-Up After Power Failure feature can only be enabled or disabled by a superuser.</p>	Cleared (Disabled)

Setting	Description	Default
Enable SSL	<p>Enable or disable Secure Socket Layer (SSL) access to the BlueScale web interface.</p> <p> Important: Enabling SSL configures the BlueScale web interface to use a secure Internet connection. You must prefix the IP address with https:// instead of just entering the IP address when accessing the BlueScale web interface.</p> <ol style="list-style-type: none"> 1. Select the Enable SSL check box to enable the option (or clear the check box to disable it). 2. Click Save. 3. Click OK in response to the notification about resetting the web server. 4. Wait for the web server to reset (approximately 2 to 3 minutes), and then log back into the library. 5. If desired, Install a Security Certificate and Authentication Key as described on page 112. 	Cleared (Disabled)
Enable SNMP Agent SNMP Settings	<p>Enable or disable the SNMP agent and configure SNMP settings.</p> <ol style="list-style-type: none"> 1. Select the Enable SNMP check box to enable the option (or clear the check box to disable it). 2. Click Save. 3. If you enabled SNMP, click SNMP Settings to configure the SNMP options. See Enable and Configure SNMP on page 116 for detailed information and instructions. 4. Click Save to save the SNMP settings and return to the System Setup screen. <p>Notes:</p> <ul style="list-style-type: none"> ▪ The option to edit the SNMP Settings is only present after you select Enable SNMP Agent and click Save. ▪ Spectra Logic libraries use SNMPv2c. 	Cleared (Disabled)
Enable Soft Power	<p>Enable or disable the Soft Power feature. See Use the Soft Power Feature on page 143 for information about the Soft Power feature and instructions for using it.</p> <ol style="list-style-type: none"> 1. Select the Enable Soft Power check box to enable the option (or clear the check box to disable it). 2. Click Save. <p>Note: The Soft Power feature can only be enabled or disabled by a superuser.</p>	Cleared (Disabled)

Setting	Description	Default
Syslog Server IP Address	<p>Enter the IP address of an external Syslog server used to collect the system messages posted by the library. See Use Syslog on page 148 for information about what the Syslog messages contain.</p> <ol style="list-style-type: none"> 1. Enter a valid IPv4 or IPv6 address for the Syslog server (or clear the IP address to disable the option). 2. Click Save. <p>The library immediately begins forwarding all system messages to the server at the specified IP address.</p>	Cleared (Disabled)
Network Settings	<p>Set the IP addressing for the LCM Ethernet port. You can also configure up to two DNS IP addresses for use with the NTP service. See Configure Network Settings on page 104 for detailed information and instructions.</p> <p>Note: Depending on how you are accessing the library, the status bar shows:</p> <ul style="list-style-type: none"> ▪ The Network Settings icon when you access the library using the touch screen or a direct connection to the LCM. ▪ The library's name, if set, when you are accessing the library using the BlueScale web interface through a web browser connection. 	Dynamic
Mail User	<p>Configure recipients for emails containing system messages, traces, and diagnostic results generated by the library. See Configure Mail Users on page 106 for detailed information and instructions.</p>	<i>autosupport@spectralogic.com</i>
Auto Configuration Save	<p>Enable or disable sending the Auto Configuration Save file to a previously configured mail recipient. See Enable Email for the Auto Configuration Save File on page 108 for detailed information about this option and instructions for configuring it.</p> <p>Note: The Auto Configuration Save file is always generated, regardless of the setting for this option. See Use Automatic Backup of the Library Configuration on page 136 for information about the Auto Configuration Save file.</p>	Cleared (Disabled)
Routine Maintenance	<p>Enable or disable the routine maintenance option for the LCM operating system. See Configure Routine Maintenance on page 115 for detailed information about this option and instructions for configuring it.</p>	Cleared (Disabled)
Date And Time	<p>See Set the Date and Time on page 110 for detailed information and instructions for setting the date and time.</p>	Date and time for the Mountain time zone (US and Canada)

Configure Network Settings

Overview Spectra Logic highly recommends that you configure your library for network access. Without network access, you are unable to perform any of the following operations:

- Access the BlueScale web interface for remote management of the library using a standard web browser.
- Open support incidents from the library front panel or send ASLs (AutoSupport Logs) on demand to Spectra Logic Technical Support for troubleshooting.
- Automatically email system messages or reports to configured mail users.
- Automatically send a notification to a specified recipient when certain critical events occur.
- Download the latest BlueScale package from Spectra Logic's Support portal directly to the library.

Using Dynamic Addressing By default, the IPv4 address for the Ethernet port on the LCM is set automatically using the Dynamic Host Configuration Protocol (DHCP) and the IPv6 address is set through dynamic address assignment.

- Notes:**
- If you select Dynamic addressing, the LCM must be connected to an Ethernet network that has a DHCP server to obtain an IP address.
 - Do not select Dynamic addressing if your network does not have a DHCP server.

Using Static IP Addressing If your network does not use DHCP, or if you want the library to use a fixed IP address, you can configure a static (fixed) IP address as described in this section. Using a static IP address ensures that the IP address for the library remains constant and is highly recommended.

Configuration Process Use the following steps to configure the library for network access.

1. Access the System Setup screen (see [Accessing the System Setup Screen on page 93](#)).
2. Click **Edit** next to Network Settings. The Network Settings screen displays.

Figure 45 The Network Settings screen.

3. Decide which type of addressing you want the library to use.
 - **Dynamic** — The library is issued an IPv4 address by the DHCP server and an IPv6 address through address assignment. Both are displayed on the Network Settings screen.
 - **Static** (highly recommended) — The library uses fixed IP addresses. If you select static addressing, enter the following information:

For this field...	Enter...
If the IPv4 check box is selected: (if the IPv4 check box is not selected, the IPv4 address defaults to 127.0.0.1 and is effectively disabled)	
IPv4 Address	A valid IPv4 address.
Subnet	The subnet mask. The subnet mask must be a valid IPv4 address.
Gateway	A valid network gateway IPv4 address. Leave the field blank if the network does not use a gateway.
If the IPv6 check box is selected:	
IPv6 Address	A valid IPv6 address. The library compresses the IPv6 address when saved.

For this field...	Enter...
Prefix Length	Enter an integer between 1 and 128 to indicate the portion of the IPv6 address that indicates a group of IP addresses on the same network.
Gateway	A valid network gateway IPv6 address. Leave the field blank if the network does not use a gateway.

4. Optionally, enter the IPv4 address for a Domain Name Server.

If you plan to use NTP to automatically set the library's date and time, you must enter a valid IPv4 address for at least one DNS server used by the NTP service (see [Set the Date and Time on page 110](#)).

- Notes:**
- Although the BlueScale software only accepts an IPv4 address for DNS devices, the library accepts both IPv4 and IPv6 addresses from the DNS devices.
 - To delete an already saved DNS setting, clear the field.

5. Click **Save** to save the IP addressing.

- Notes:**
- If you are connected to the library through the BlueScale web interface and you change the addressing, the library's IP address changes as soon as you click **Save**. As a result, you lose the connection to the library.
 - If you are using the operator panel, select any option on the toolbar menu to leave the Network Settings screen.

Configure Mail Users

Overview The library can send email messages with system messages, traces, and diagnostic results to selected recipients. These recipients can be configured to receive messages automatically as they are generated by the library, or on demand when traces are run, reports are generated, or the library's configuration data is backed up. Recipients can also be configured to receive AutoSupport messages.

- Notes:**
- The library must be connected to a network with Internet access before you configure mail recipients.
 - You must configure the SMTP server used by the *autosupport@spectrallogic.com* mail user if you want to open an AutoSupport ticket directly from the library (see [Chapter 11 – Configuring and Using AutoSupport](#), beginning on [page 297](#)). This mail user is also used to send the ASL and HHM files that the library generates to Spectra Logic Technical Support when troubleshooting a problem.

Add or Modify Mail Users Use the following steps to add or modify mail recipients.

1. Access the System Setup screen (see [Accessing the System Setup Screen](#) on page 93).
2. Click **Edit** next to Mail Users. The Mail Recipients screen displays.

Figure 46 The Mail Recipients screen.

3. To modify an existing recipient, click **Edit** next to the desired recipient in the Recipients pane.

The Add/Update Recipient pane refreshes to show the current information for the selected recipient.

4. Enter the information for a new recipient or update the information for an existing recipient in the Add/Update Recipient pane.

For this field...	Do the following...
To	<p>Enter the email address of the recipient. Be sure to use the full address using the standard email format, including the @ symbol.</p> <p>! Important: The email address cannot contain spaces or other non-alphanumeric characters (for example, an ampersand, &). To include multiple addresses, leave a space between each address.</p>
From	<p>Enter an alphanumeric string to uniquely identify the library (for example, the name or location of the library).</p> <p>! Important: The string cannot contain spaces or non-alphanumeric characters (for example, the & or the @ symbols).</p>

For this field...	Do the following...
SMTP IP Address	Enter the IPv4 or IPv6 address of your SMTP server in the SMTP IP Address field.
Receive	<p>Select the type(s) of messages that the user receives by selecting one or more of the message types listed.</p> <ul style="list-style-type: none"> ▪ Fatal — An error occurred that prevents the library from continuing operation. Immediate attention is required. ▪ Error — An error occurred that impacts the operation of the library. Determine the cause of the error and remedy it as soon as possible. ▪ Warning — The library detected conditions that may impact operation. Determine the cause of the problem and remedy it as soon as possible. ▪ Informational — Activities that generate system messages occurred. <p>Notes:</p> <ul style="list-style-type: none"> ▪ Selecting a message type automatically sends all messages of that type to the recipient as they are generated by the library. ▪ If no message type is selected, the library does not automatically send messages to the recipient. However, messages can still be sent to the recipient on an individual basis when traces or diagnostics are run. ▪ Do not select message types for the <i>autosupport@spectralogic.com</i> mail recipient. This mail recipient is only used to receive AutoSupport ticket requests or ASL and HHM files that are generated by the library.

5. Click **Save**. The screen refreshes to show the new or updated mail recipient in the Recipients portion of the Mail Recipient screen (Figure 46 on page 107).
6. If desired, select **Send Test** next to the newly added mail recipient to send a test email.
7. Repeat [Step 2 on page 107](#) through [Step 6](#) on this page to configure or modify additional email recipients.
8. Click **Previous** to return to the System Setup screen.

Enable Email for the Auto Configuration Save File

Overview Having a current backup of the library's metadata (the library partition configuration, the MLM and DLM databases, and any BlueScale encryption keys) is an essential component of any disaster recovery plan. For more information about protecting the library metadata, see [Back Up and Protect the Library Metadata on page 455](#).

In the event that you need to restore the library configuration, you can use either the automatically saved configuration backup file from the LCM or the emailed copy (see [Restore From an Auto Configuration Save File on page 341](#)).

Auto Configuration Save Process The library generates an Auto Configuration Save backup file once a week and every time you create or modify a partition. This backup file contains the current library configuration, the MLM and DLM databases, and any BlueScale encryption keys stored in the library.

- Notes:**
- The time for generating the weekly Auto Configuration Save backup file is based on the first time the file was generated.
 - The library does not generate an Auto Configuration Save backup file when you make configuration changes other than creating or modifying a partition.

Auto Configuration Save Email Process Configuring the library to automatically send the Auto Configuration Save backup file as an email attachment to a previously configured email recipient is highly recommended. The library sends the email whenever it generates the Auto Configuration Save backup file. The email includes instructions for using the attached file to restore the library.



Important

To use this automatic email option, you must first configure the user to whom you want the backup file sent as a mail recipient (see [Configure Mail Users on page 106](#)).

Configure Automatic Email Option Use the following steps to configure the automatic email option for the Auto Configuration Save backup file.

1. Access the System Setup screen (see [Accessing the System Setup Screen on page 93](#)).
2. Click **Edit** next to Auto Configuration Save in the Other Settings pane. The Automatic Configuration Save Setup screen displays.

Figure 47 The Automatic Configuration Save Setup screen.

3. Select the **Email Configuration** check box, and then use the drop-down list to select the desired recipient from the list of previously configured mail recipients.

Note: Do not use the default *autosupport@spectralogic.com* email recipient. Spectra Logic does not save emailed configuration files.

Set the Date and Time

1. Access the System Setup screen (see [Accessing the System Setup Screen on page 93](#)).
2. Click **Edit** next to **Date And Time** in the Other Settings pane. The Date and Time screen displays showing the method currently selected for setting the date and time.
3. Select the method you want to use for setting the date and time.

Note: Changing the method of setting the library time and date from **Automatic Time and Date Settings (NTP)** to **Manual Time and Date Settings** or the other way around requires an LCM reboot to enable the new setting.

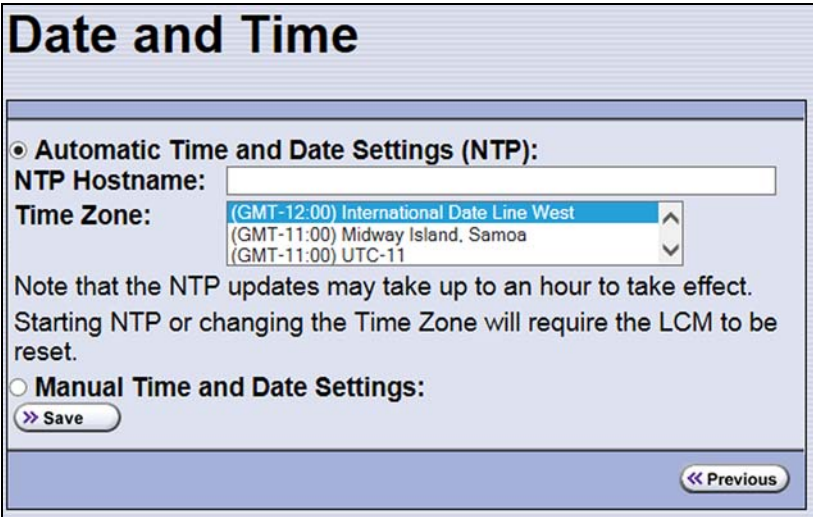
If you select...	Then...
Automatic Time and Date Settings (NTP)	<p>If not already displayed, the Date and Time screen refreshes to show options for configuring a Network Time Protocol (NTP) server.</p>  <p>Figure 48 Configure the settings for using NTP.</p> <ol style="list-style-type: none"> 1. Enter the NTP Hostname for the NTP server you want to use. Do not include !@#%^&*()> and < in the NTP hostname (for information about NTP, see http://support.ntp.org/bin/view/Main/WebHome). 2. Select the Time Zone you want to use (typically the one corresponding to the location of the library). 3. Click Save. As soon as you click Save, the library reboots to start using the new settings. <p>Notes:</p> <ul style="list-style-type: none"> ▪ Because the NTP server is addressed using a hostname instead of an IP address, you must configure at least one DNS server before you can use NTP (see Configure Network Settings on page 104). ▪ After you configure NTP, it can take up to an hour for the time to synchronize with the NTP server.

If you select...	Then...
<p>Manual Time and Date Settings (Default)</p>	<p>If not already displayed, the Date and Time screen refreshes to show options for manually setting the date and time.</p> <div data-bbox="444 306 1224 810" style="border: 1px solid black; padding: 10px;"> <p>Date and Time</p> <p> <input type="radio"/> Automatic Time and Date Settings (NTP): <input checked="" type="radio"/> Manual Time and Date Settings: </p> <p>Date: Month: <input type="button" value="-"/> Jun <input type="button" value="+"/> Day: <input type="button" value="-"/> 13 <input type="button" value="+"/> Year: <input type="button" value="-"/> 2011 <input type="button" value="+"/> </p> <p>Time: Hour: <input type="button" value="-"/> 15 <input type="button" value="+"/> (24-hour clock) Minute: <input type="button" value="-"/> 16 <input type="button" value="+"/> </p> <p><input type="button" value="» Save"/></p> <p style="text-align: right;"><input type="button" value="« Previous"/></p> </div> <p>Figure 49 Configure the settings for manually setting the date and time.</p> <ol style="list-style-type: none"> Use the Date and Time + and – buttons to select the month, day (date), year, hour, and minute values. <p>Note: The values in the Date & Time counters do not wrap. For example, to change the month from December to January, click and hold the – button to decrement the month.</p> <ol style="list-style-type: none"> Click Save. Click Previous to return to the System Setup screen.

CONFIGURING OPTIONAL LIBRARY SETTINGS

This section describes optional configuration settings that you may select to use for your library and operating environment.

Install a Security Certificate and Authentication Key

If you enabled SSL (see [Enable SSL on page 102](#)), use the following steps to obtain and install a security certificate and private key.

1. Obtain a security certificate and private key using one of the following methods:



Important

The `ssl.crt` and `ssl.key` files can only contain ONE certification or key. The BlueScale software does not support multiple keys (chaining keys) in the key or certificate files. If there are multiple keys in the files, they are all considered invalid.



Important

When generating a self signed certificate using `openssl`, use the `-x509` command line option. Loading a file without this option may cause the LCM to hang.



Important

When generating a self signed certificate or a certificate signing request using `openssl`, use the `-nodes` command line option to prevent the key from being encrypted.

- Create a Self-Signed Certificate

For example, to create a self-signed certificate and authentication key using `openssl`, use the following command.

```
openssl req -x509 -nodes -days 365
-newkey rsa:2048 -keyout ssl.key -out ssl.crt
```

The `openssl req` command is a certificate request and certificate generating utility. The following parameters are used in the example:

- `-x509` - This option outputs a self signed certificate instead of a certificate request.
- `-nodes` - This option specifies that the private key not be encrypted.
- `-days n` - When the `-x509` option is also used, this option specifies the number of days (`n`) that the certificate is valid.
- `-newkey rsa:nbits` - Generates an RSA key `nbits` in size. The Library supports RSA keys in bits of 512, 768, 1024 and 2048.
- `-keyout filename` - This option specifies the private key file name.
- `-out filename` - This option specifies the certificate file name.

After entering the command, you are prompted to provide the following information. Sample responses are shown.

- Country Name (2 letter code) [AU]: US
- State or Province Name (full name) [Some-State]: Colorado
- Locality Name (eg, city) []: Boulder
- Organization Name (eg, company) [Internet Widgits Pty Ltd]: Spectra Logic
- Organizational Unit Name (eg, section) []: DVT Test

- Common Name (e.g. server FQDN or YOUR name) []:
T950V@company.com
- Email Address []: support@company.com
- Request a Certificate Using a Certificate Signing Request

Request a security certificate and the authentication key from your signing authority and process the key for use in with the BlueScale software.

- a. Request a certificate from www.verisign.com, www.instantssl.com, www.letsencrypt.org or another SSL certificate vendor to obtain the certificate. For example, to generate a certificate signing request using openssl, use the following command:

```
openssl req -newkey rsa:2048 -nodes
-subj "/C=US/ST=Colorado/L=Boulder/O=Spectra/CN=DVT-
T950V" -out ssl.csr -keyout ssl.key
```

The openssl req command is a certificate request and certificate generating utility. The following parameters are used in the example:

- -newkey rsa:nbits - Generates a new certificate signing request and a new RSA private key nbits in size. The Library supports RSA keys in bits of 512, 768, 1024 and 2048.
 - -nodes - This option specifies that the private key not be encrypted.
 - -subj "arg" - This option provides the answers to many of the prompts shown in the example above.
 - -keyout filename - This option specifies the private key file name.
 - -out filename - This option specifies the certificate signing request file name.
- b. Send the certificate signing request to the signing authority. A certificate named ssl.crt and a key named ssl.key will be returned.
2. The BlueScale web server must use an RSA private key and cannot use a key with a passphrase. If the private key does not include BEGIN RSA PRIVATE KEY in the header or uses a passphrase, rename the key to original_ssl.key and issue the following command.

```
openssl rsa -in original_ssl.key -out ssl.key
```

If the key has a passphrase, issuing this command prompts you for the passphrase.

3. Save the security certificate file (ssl.crt) and the private key (ssl.key) in the root folder of a USB device.

Note: The security certificate file must be named ssl.crt and the private key must be named ssl.key.

4. Connect the USB device to a port on the LCM (Figure 9 on page 39) or the front panel and wait for the device to mount.
5. Log into the library as a user with superuser or administrative privileges (see [Log Into the User Interface](#) on page 82).
6. From the toolbar menu, select Maintenance > Tools. The Maintenance Tools screen displays.
7. Select **Utilities**. The Utilities screen displays.
8. Click **Show Advanced**. The Advanced Utilities Confirmation screen displays.
9. Click **Next**. The Utilities screen refreshes to show a list of the advanced utilities.
10. Scroll through the list of advanced utilities and select the **Load SSL Certificate and Key from USB** utility.



Figure 50 Use the **Load SSL Certificate and Key from USB** utility to load the security certificate onto the library.

11. Click **Run Utility** to copy the security certificate and private key to the T950V library web server.

- Notes:
- The SSL keys are not stored as part of the library configuration. If you replace the SD card, you will have to reload these keys.
 - To change or update the SSL keys, you must first manually delete the old keys from the LCM. Contact Spectra Logic Technical Support for assistance (see [Contacting Spectra Logic](#) on page 7).

Configure Routine Maintenance

Overview The Routine Maintenance option configures the library to automatically reset (reboot) the LCM once a week. Using this option is not required as part of normal library operation and should be left disabled unless you are requested to enable this by Spectra Logic Technical Support in the course of troubleshooting or problem resolution.



Important

Do not enable this option unless specifically instructed to do so by Spectra Logic Technical Support.

Enable the Routine Maintenance Option Use the following steps if Spectra Logic Technical Support instructs you to enable the Routine Maintenance option.

1. Access the System Setup screen (see [Accessing the System Setup Screen on page 93](#)).
2. Click **Edit** next to **Routine Maintenance** in the Other Settings pane. The Routine Maintenance Configuration screen displays.

Figure 51 The Routine Maintenance Configuration screen.

3. Select **Enable** to enable the Routine Maintenance option.
4. Use the **Day of Week**, **Hour**, and **Minute** drop-down lists to select when you want the automatic reboot to occur.

Note: When the library automatically resets, all data storage operations currently in progress fail. Spectra Logic recommends that you select a time when you are not performing data storage operations.

5. Click **Save** to finish. Click **Previous** to return to the System Setup screen.

Enable and Configure SNMP

Overview Simple Network Management Protocol (SNMP) is a protocol for monitoring the health and welfare of your library by using integrated alerts. When SNMP is enabled, the Other Settings pane in the System Setup screen includes options for enabling the SNMP agent and configuring SNMP settings.

Note: Spectra Logic libraries use SNMPv2c.

Network-Based Library Management If you are using a network-based library monitor/management application other than the library's BlueScale user interface, you may need to identify the library's SNMP settings to the application. These settings include the read, write, and broadcast community strings.

Configure SNMP Use the following steps to enable and configure SNMP.

1. Access the System Setup screen (see [Accessing the System Setup Screen on page 93](#)) and scroll down to the Other Settings pane.
2. Select **Enable SNMP Agent** to enable SNMP in the library and click **Save**. The System Setup screen refreshes to include an option for editing the SNMP settings.

The agent returns information contained in the library's Management Information Base (MIB) to the workstation used to manage the network. The MIB defines what information is available from the library over the network. The MIB file is available for download from the [Downloads](#)  [Tools](#) page of the support portal.

3. Click **Edit** next to **SNMP Settings**. The SNMP Settings screen displays.

SNMP Settings

MIB-II System Values

System Contact: » Save

System Location: » Save

Valid Query Communities

Community	Actions
public	✖ Delete » Edit

Add/Update Valid Query Communities

Community: » Save

Trap Destinations

Community	Description	IP Address	Actions
public	T950 at YourCompany	192.168.57.123	✖ Delete » Edit

Add/Update Trap Destinations

Community:

Description:

IP Address: » Save

« Previous

Figure 52 The SNMP Settings screen.

4. Enter the following information on the SNMP Settings screen.

Field	Description
System Contact	Maps to the value for system.4 (sysContact) object in the MIB. Enter the informations and click Save .
System Location	Maps to the value for system.6 (sysLocation) object in the MIB. Enter the informations and click Save .
Valid Query Communities	<p>Lists all SNMP communities to which the library currently belongs. The library only responds to SNMP queries from members of these communities. The default valid query community is public.</p> <ul style="list-style-type: none"> Click Edit next to the setting you need to modify. The current settings display in the corresponding Add/Update section of the screen. Click Save in the corresponding Add/Update section of the screen after you make your changes. <p> Important: Community strings are case sensitive. If the library is configured to include the community called "OurCommunity," it answers to queries from OurCommunity but not from a community called "ourcommunity."</p> <ul style="list-style-type: none"> Click Delete to remove a setting.
Trap Destinations	<p>Lists all the currently configured trap destinations (IPv4 or IPv6 addresses) to which the library sends SNMP traps. There are no default trap destinations configured.</p> <p>Note: Only one community at a time may contain IPv6 addresses.</p> <ul style="list-style-type: none"> Click Edit next to the setting you need to modify. The current settings display in the corresponding Add/Update section of the screen. Click Save in the corresponding Add/Update section of the screen after you make your changes. Click Delete to remove a setting.

5. Click **Previous** to return to the System Configuration screen.

Configure Controller Failover

Overview The library supports using two RIM2s to provide a redundant connection to the robotics. A single controller can be configured as the failover controller for multiple partitions. See [Controller Failover on page 66](#) for information about how controller failover functions.

To use the controller failover feature, you must assign a failover partner to the controller you selected to provide the partition's robotic control path to the robotics.

- Notes:**
- Drives used to provide the robotic control path cannot be configured with controller failover, however you can export the same changer interface over multiple drives in the partition to provide redundancy as long as your software can support this. You cannot use multiple paths at the same time.
 - If desired, you can configure multiple RIM2s for the same partition and export the same changer interface over them to provide redundancy as long as your software can support this.
 - If you configure controller failover before you create storage partitions, the secondary controller in the failover pair is not available for use as the exporting controller for the partitions.

User Privilege Requirements Only a user with superuser or administrator privileges can configure controller failover. See [Understanding User Groups and Security on page 90](#) for information about the three types of user groups and what types of privileges each has.

Configure Controller Failover Use the following steps to enable and configure controller failover.

1. Log into the library as a user with superuser or administrator privileges.

- From the toolbar menu, select **Configuration**  **Controllers** to display the Controllers screen.



Figure 53 The Controllers screen before the failover controller is selected.

- Identify the controller that you configured to provide the robotic control path in a partition (see [Select the Robotic Control Path on page 172](#)). This controller is the primary controller in the failover pair.

Note: If you have not yet configured partitions, identify two controllers (RIM2s). Both controllers must be at the same firmware version.

- Click **Failover** next to the controller you want to be the primary controller in the failover pair. The Controller Failover screen displays with a list of the other RIM2s in the library that can be used as the failover partner.

Note: The component identifiers for the RIM2s show them as F-QIPs. See [RIM2 Identifiers on page 57](#) for more information.

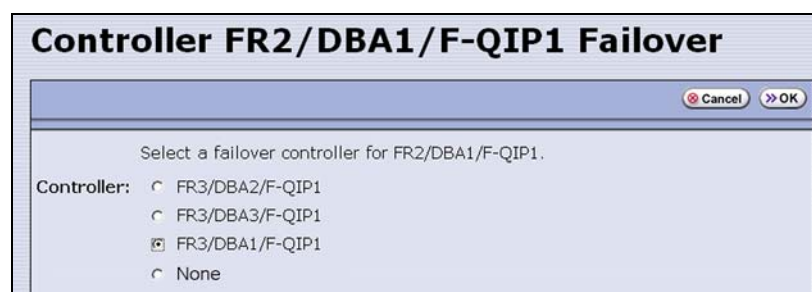

Figure 54 The Controller Failover screen.

5. Select the controller that you want to use as the failover partner for the primary controller. This controller is the secondary controller in the failover pair.



Important

Make sure that the controller you select is not already being used to provide the robotic control path for another partition.

- Notes:**
- To disable controller failover, select **None**. This is the default setting.
 - When you select **None** or if you select a different controller as the failover partner, the controller previously configured as the failover partner is once again available for use in a partition.
6. Click **OK** to complete the assignment. The Controllers screen redisplay to show the two controllers configured as a failover pair.

For example, in [Figure 55](#) the RIM2 identified as FR2/DBA1/F-QIP1 is the primary controller in the failover pair and provides the robotic control path for any partitions in which it is used. The RIM2 identified as FR3/DBA1/F-QIP1 is the secondary controller in the failover pair and automatically takes over for the primary controller if it detects a problem.

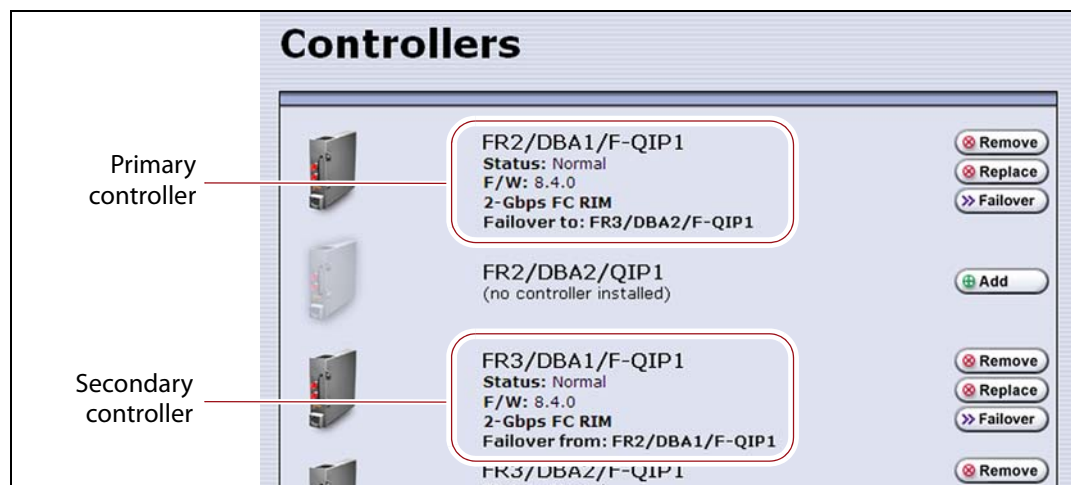

Figure 55 The Controllers screen after configuring controller failover.

To use the configured failover pair in a partition, select the controller that is the primary controller (see [Step 3 on page 120](#)) as the exporting controller (see [Select the Robotic Control Path on page 172](#)).

Configure Emulation

Overview The library identifies itself as “SPECTRA PYTHON” in response to a SCSI Inquiry command. If your storage management software or operating system does not specifically support one of the Spectra Logic libraries that identifies itself as “SPECTRA PYTHON,” you can configure one or more partitions to emulate another type of library. Because most storage management software is certified for one or more of these libraries, using the emulation mode may allow these applications to support the library.



Caution

Using emulation is not the preferred method of operation and should only be used when recommended by Spectra Logic Technical Support.

- Notes:**
- Configuring emulation changes how the library identifies itself to the operating system or storage management software.
 - The following instructions describe an advanced partition configuration option that is used only in the context of creating or editing a partition. The screens for configuring emulation are only accessible after you complete the initial configuration steps for the partition (see [Define the Initial Storage Partition Settings](#) on page 169).

User Privilege Requirements Only a user with superuser or administrator privileges can configure emulation. See [Understanding User Groups and Security](#) on page 90 for information about the three types of user groups and what types of privileges each has.

Configure Emulation Use the following steps to configure a partition to emulate another type of library.

1. Log in as a user with superuser or administrator privileges.
2. From the toolbar menu, select **Configuration ...⚙️ Partitions**. The Shared Library Services screen displays.
3. Click **Edit** to modify an existing partition or **New** to create a new partition. The Name and Media Type screen displays (see [Figure 86](#) on page 171).

- Click **Advanced**. The Advanced Partition Settings screen displays.

Advanced Partition Settings

<< Previous Cancel >> Next

These settings allow you to control the library emulation for the partition. The default preset is appropriate for most installations.

Caution: Setting the library emulation incorrectly could cause compatibility issues with your software package. Check with your software vendor or Spectra Logic technical support before changing these settings.

Choose a preset user emulation or choose "USER DEFINED" and enter the Vendor and Model below.

Emulation: Use preset:
 Use custom: Vendor:
 Model:

Emulation Options: Include tape generation in Read Element Status

Figure 56 Specifying the emulation type.

- Select the type of library you want the T950V library to emulate. You can either:
 - Select a preconfigured emulation from the **Use preset** drop-down list.
 - OR —
 - Create a custom emulation, enter the **Vendor** and **Model** for the library to be emulated. These fields are used in the string that the library returns in response to a SCSI Inquiry command.

Note: The default setting is SPECTRA PYTHON.

- If you want the SCSI Read Element Status command response to include Media Domain, Media Type, Drive Domain, and Drive Type, select **Include tape generation in Read Element Status**. See the *Spectra Tape Libraries SCSI Developer's Guide* for more information.
- Click **Next**. The Robotic Control Path screen displays listing the controllers currently installed in the library.

The Robotic Control Path screen is the beginning of a series of configuration screens. The sequence of steps and screens matches those described in [Creating a Storage Partition](#) on page 169.

Configure Barcode Reporting

Overview The Spectra Logic tape libraries support barcode data strings consisting of a start character; from 1 to 16 characters, including alphanumeric characters and an optional checksum character; and the stop character. Quiet zones precede and follow the start and stop characters.

By default, the library:

- Expects barcode labels with checksums (that is, it treats the right-most character as a checksum character).
- Does not use the checksum character to validate the barcode.
- Reports up to 16 characters but does not report the checksum character.

Note: With the exception of the checksum, the barcode labels typically show the human-readable character that each barcode character represents. The checksum character is not considered human-readable.

Modifying Barcode Reporting If your environment has any of the following:

- Labels without a checksum character
- A requirement to validate the barcode using the checksum
- Storage management software with specific barcode requirements

then you may need to modify the default settings used by the library.



Important

- Proceed with caution when changing the library's default barcode reporting settings. Any changes that you make affect every partition in the library. Before making changes, make sure that the changes do not adversely affect others using the library.
- If you modify the barcode reporting settings, you should do so before using any cartridges in the library. If you change the barcode reporting settings after the cartridges were used by the storage management software, the software may no longer recognize those cartridges. In general, it is best to leave the library set to its defaults and make any reporting modifications on the software side if that is an option.
- Never mix cartridges with checksummed and non-checksummed labels in the library.

Barcode Reporting Mismatch Errors Unexpected behavior can occur if the library's barcode reporting configuration does not match the type of barcode labels that are being used **and** what the storage management software expects. The most common problems that occur are:

- The library is configured to expect a checksum character in barcodes, but the barcode labels do not have a checksum character. In this case, the barcode reported by the library is “missing” the right-most character. This is because the library treats the last character in the barcode as a checksum character, which it does not report, when the character is actually part of the barcode.
- The library is configured to use barcode labels that do not include a checksum, but the barcode labels include a checksum character. In this case, the library treats the checksum character as part of the barcode and therefore reports a seemingly random “garbage” character as the last character of the barcode.
- The library is configured to use barcodes that include a checksum and perform checksum verification, but the barcode labels do not have a checksum character. In this case, the library reports a verification error on every barcode label because the character it is using to perform the checksum verification is not a checksum character.

User Privilege Requirements Only a user with superuser or administrator privileges can modify barcode reporting. See [Understanding User Groups and Security on page 90](#) for information about the three types of user groups and what types of privileges each has.

Changing the Library Barcode Reporting Configuration

Note: If you are unsure whether your labels include a checksum character, see [Determining the Barcode Label Type on page 127](#).

If necessary, use the following steps to change the library's barcode reporting configuration to disable the use of checksum characters, enable or disable the verification of the checksum character, or modify what portion of the actual barcode is reported to the host.



Important

After the utility completes, the LCM reboots. After the library completes its initialization, it rescans the barcode labels of all media in the library. This rescan takes up to 45 minutes per frame to complete.

1. Log into the library as a user with superuser or administrator privileges.
2. From the toolbar menu, select **Maintenance**  **Tools**. The Maintenance Tools screen displays.
3. Select **Utilities**. The Utilities screen displays.
4. Click **Show Advanced**. The Advanced Utilities Confirmation screen displays.

5. Click **Next**. The Utilities screen refreshes to show a list of the advanced utilities.
6. Select the **Modify Barcode Reporting** utility. The screen refreshes to show information about the utility. [Figure 57](#) shows the default settings.

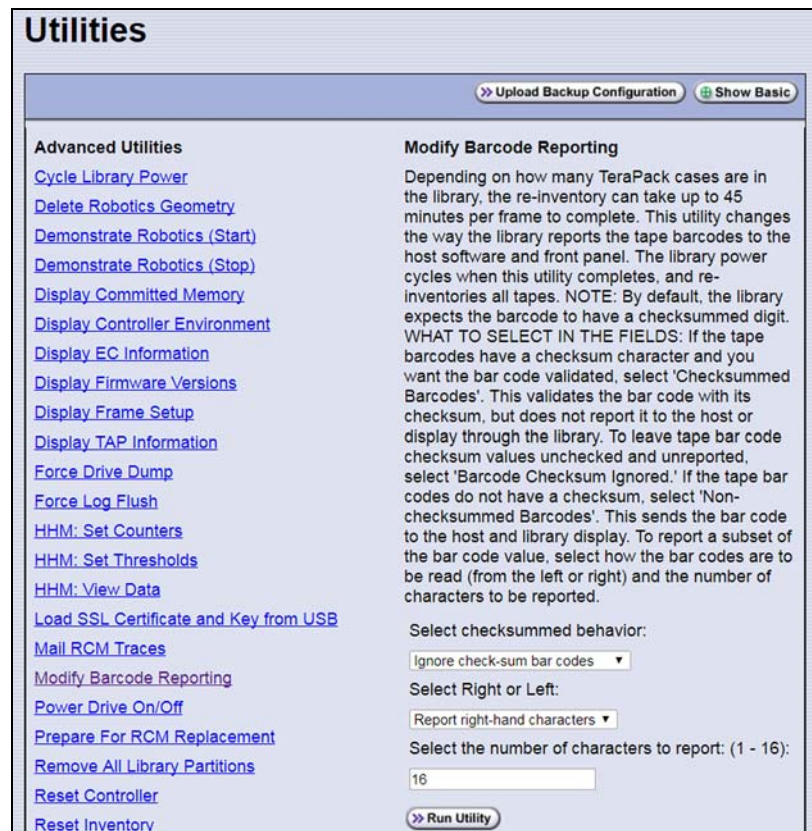



Figure 57 Use the Modify Barcode Reporting utility to change how the library handles barcode labels.

7. Change the barcode reporting as required for your environment.

Use this parameter	If...
Non-check-summed barcodes	Your labels do not include a checksum.
Check-summed barcodes	Your labels include a checksum and you want the barcode verified against the checksum when it is read. Verification is not generally required, but adds extra confirmation that the barcode label was read correctly by the barcode reader.
Ignore check-sum barcodes	Your labels include a checksum character but you do not want the barcode verified against the checksum when it is read. This is the default setting.
Report left-hand characters	<p>You want the library to report only the left-most x characters in the barcode, where x is any number from 1 to 16.</p> <p>For example, if the barcode is 1234567L2 and you configure the library to report only the five left-most characters, the library reports the barcode as 12345.</p> <p> Important: Be careful when specifying the number of left-most characters to report. You may end up with duplicate barcodes reported. For example, 12345XXXL2 and 12345ABCL3 are both reported as 12345.</p>

Use this parameter	If...
Report right-hand characters	<p>You want the library to report only the right-most x characters in the barcode, where x is any number from 1 to 16. This is the default setting.</p> <p>For example, if the barcode is 1234567L2 and you configure the library to report the 5 right-most characters, the library reports the barcode as 567L2.</p> <p> Important: Be careful when specifying the number of right-most characters to report. You may end up with duplicate barcodes reported. For example, 1234567L2 and ABCD567L2 are both reported as 567L2.</p>

8. If you want to specify the number of barcode characters the library reports, enter a number from **1** to **16** in the **Select the number of characters to report** field. If your labels include a checksum, the number you enter includes the checksum character. The default number of characters is 16.
9. Click **Run Utility**. When the utility completes, the LCM reboots. After the library completes its initialization, it rescans the barcode labels of all media in the library. This rescan takes up to 45 minutes per frame to complete.

Determining the Barcode Label Type

A checksum character is an “invisible” character — readable by the barcode reader, but not shown in the human-readable text on the label. Its function is similar to a parity check.

See [Barcode Label Specifications on page 492](#) for detailed information about the required physical characteristics of barcode labels.

If you have...	The barcode labels...
Spectra Certified data cartridges with standard barcode labels	Have a barcode with eight human-readable characters followed by a checksum character that is not human-readable. The last two human-readable characters indicate the media type (for example L6 indicates LTO-6 media and JC indicates TS11xx technology media).
Spectra Certified data cartridges with custom barcode labels	Are designed to a user’s specification. Custom labels support up to 16 characters including an optional checksum character.
Barcode labels purchased from different vendors	<p>Must always either include or not include a checksum. When ordering labels, make sure that you always specify the same type of barcodes (always include or always do not include a checksum).</p> <p> Important: Never mix media with checksummed and non-checksummed labels in the library.</p>

Use the following steps to determine if the barcode labels on your cartridges include a checksum character.



Important

After the utility completes, the LCM reboots. After the library completes its initialization, it rescans the barcode labels of all media in the library. This rescan takes up to 45 minutes per frame to complete.

1. Log into the library as a user with superuser or administrator privileges.
2. From the toolbar menu, select **Maintenance**  **Tools**. The Maintenance Tools screen displays.
3. Select **Utilities**. The Utilities screen displays.
4. Click **Show Advanced**. The Advanced Utilities Confirmation screen displays.
5. Click **Next**. The Utilities screen refreshes to show a list of the advanced utilities.
6. Select the **Modify Barcode Reporting** utility. The screen refreshes to show the details for the utility.
7. Make sure that the options for the utility are set as follows:

For this field...	Make sure it is set to...
Select checksummed behavior	Ignore check-sum barcodes
Select Right or Left	Report right-hand characters
Select the number of characters to report: (1 - 16)	16

8. Examine each barcode label you want to test and make a note of the human-readable text on each.
9. Import the cartridges into a storage partition, then view the partition inventory, either on the BlueScale Inventory screen (see [View the Cartridge Inventory for a Location on page 225](#)) or through your storage management software.
 - If the reported barcode exactly matches the human-readable text you recorded, then the barcode includes a checksum character.
 - If the reported barcode is missing the right-most character, then the barcode does not include a checksum character.
10. See [Changing the Library Barcode Reporting Configuration on page 125](#) to configure the barcode reporting to match your barcodes.

Configure a Package Server

Overview Configuring a package server is optional. A local package server can be used to store BlueScale packages downloaded from Spectra Logic for updating the BlueScale software or library component firmware. Update packages can also be downloaded directly from the Spectra Logic website to the memory card in the library's LCM or to a USB device.

Note: For additional information about BlueScale packages and how to use them, see [Updating the BlueScale Software and Library Firmware](#) on page 388.

User Privilege Requirements Only a user with superuser or administrator privileges can configure a package server.

Configure a Package Server Use the following steps to configure, modify, or delete a local package server.

1. Identify the server or servers you want to use for storing BlueScale packages. Make sure that these servers can access the Internet and that they are on the same network as the libraries you want to update.

Note: Both Microsoft Internet Information Services (IIS) and the Unix-based Apache server work as package servers.

2. Log into the library as a user with superuser or administrator privileges.
3. Select **Maintenance** > **Package Update**. The Package Update screen displays.

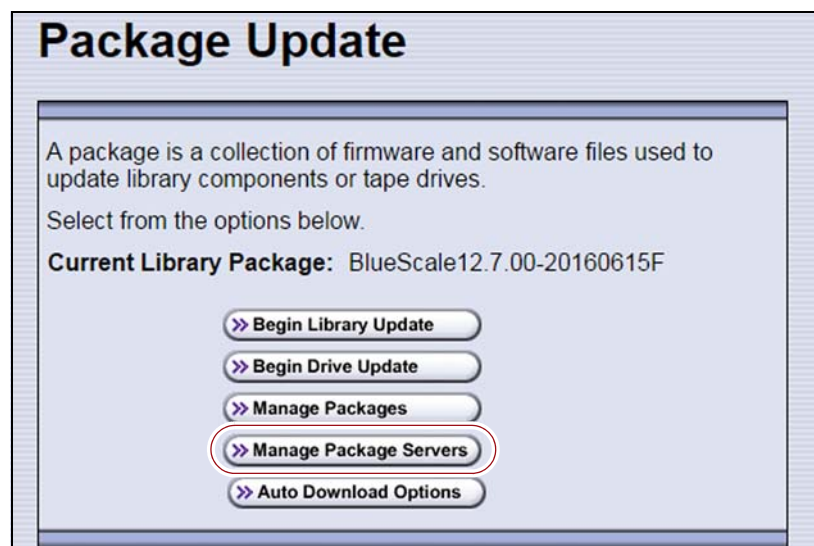

Figure 58 The Package Update screen.

4. Click **Manage Package Servers**. The Manage Package Servers screen displays, and provides the following information for each currently configured package server:
 - **Server name** — Name assigned to the server when it was added.
 - **Server configuration settings** — Includes the IP address of the package server, the port, the IP address of the proxy server (if configured), and the directory where BlueScale packages are stored.
 - **Auto Download setting** — Indicates whether Auto Download is configured. If configured (See [Add a Package Server on page 131](#)), the library checks the package server once a week for a library update package and drive firmware package newer than what the library is currently running. If a new package is available, the library downloads it, generates a system message, and displays an icon on the status bar to indicate the update is available (see [Auto Download Icon on page 79](#)). To modify auto download options, see [Modify Auto Download Options on page 132](#).

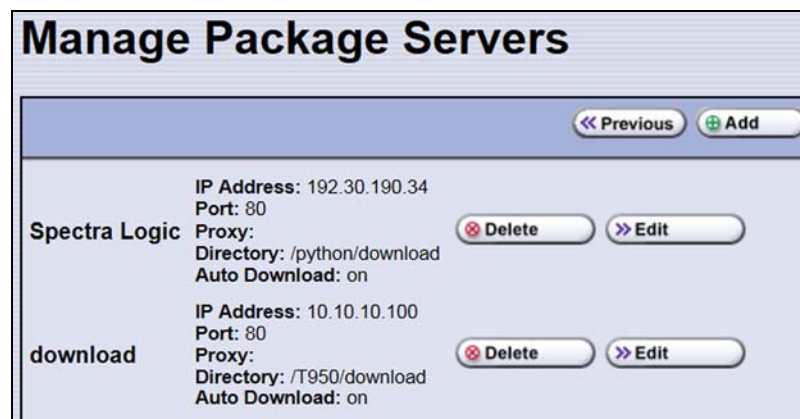
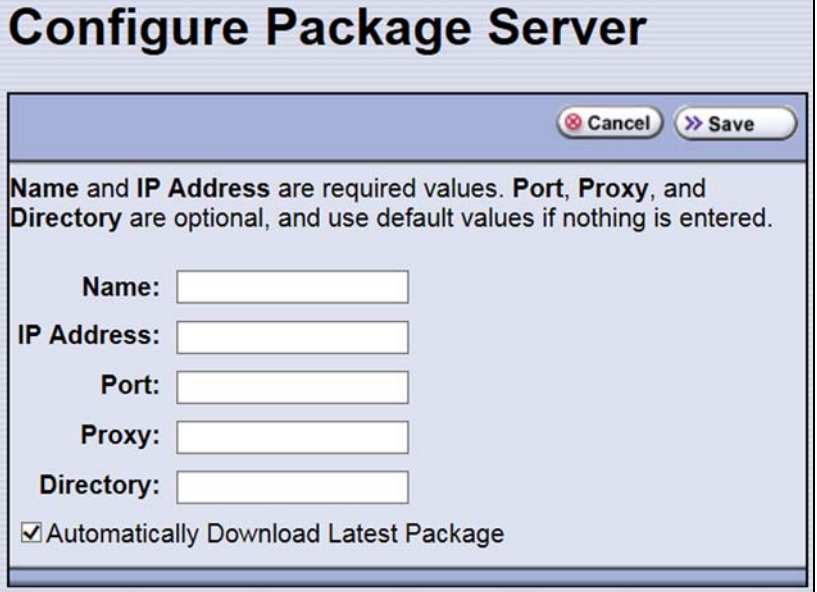



Figure 59 The Manage Package Servers screen.

5. Click the correct button to add, delete, or edit a package server.

Task	Procedure
Add a Package Server	<p>1. Click Add. The Configure Package Server screen displays.</p>  <p>Figure 60 The Configure Package Server screen.</p> <p>2. Fill in the requested information:</p> <ul style="list-style-type: none"> ▪ Required — Name and IP Address. If no Proxy is set, the IP Address can be an IPv4 or an IPv6 address. If a Proxy is set, the IP Address must use IPv4. ▪ Optional — Port, Proxy, and Directory fields use default values if nothing is entered. The Proxy, if set, must use IPv4. <p>3. Select or clear Automatically Download Latest Package.</p> <ul style="list-style-type: none"> ▪ If selected, the library checks the package server once a week for a library update package and drive firmware package newer than what the library is currently running. If a new package is available, the library downloads it, generates a system message, and displays an icon on the status bar to indicate the update availability. ▪ If cleared, you must check for updates manually. <p>4. Click Save. The screen refreshes and adds the new server to the list of available package servers.</p> <p>Note: If you specify the directory, make sure you include the full path to the directory where the BlueScale packages are stored.</p>
Edit a Package Server	<p>1. Click Edit next to the server's name and details. The Configure Package Server screen displays, with the appropriate fields completed.</p> <p>2. Edit the server information as necessary.</p> <p>3. Click Save.</p>
Delete a Package Server	<p>Click Delete next to the server's name and details.</p> <p> Important: There is no confirmation requested when you delete a package server. After you click Delete, the server is immediately removed from the list of available package servers. However, the packages on the server are not deleted.</p>

Modify Auto Download Options

Overview When auto download is enabled for a package server (see [Add a Package Server on page 131](#)) you can configure when the library sends notification of a new downloaded package update or drive firmware update, and whether the download is automatically staged to library devices capable of staging.

Note: For additional information about BlueScale packages and how to use them, see [Updating the BlueScale Software and Library Firmware on page 388](#).

User Privilege Requirements Only a user with superuser or administrator privileges can configure auto download options.

Configure Auto Download Options Use the following steps to configure or modify auto download options.

1. Log into the library as a user with superuser or administrator privileges.
2. Select **Maintenance** > **Package Update**. The Package Update screen displays.



Figure 61 The Package Update screen.

3. Click **Auto Download Options**. The Auto Download Options screen displays showing the current auto download settings.

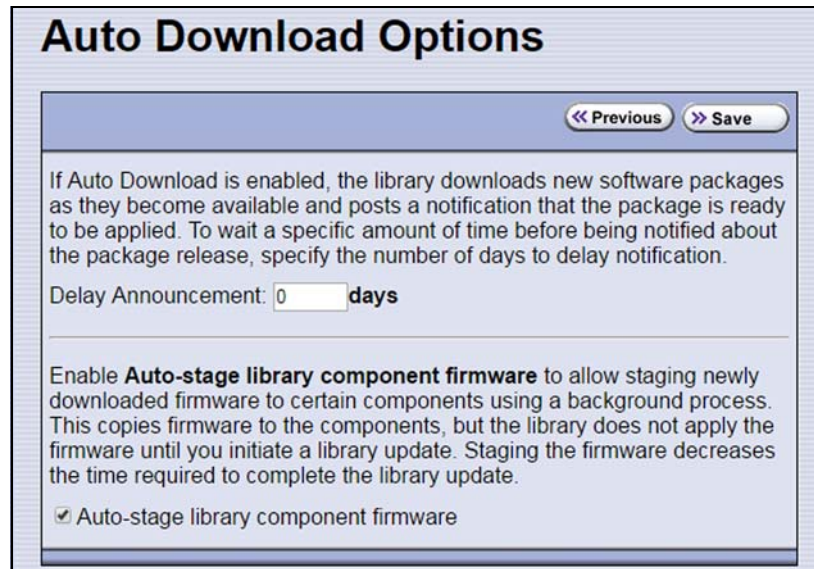

Figure 62 The Auto Download Options screen.

4. If you want to delay the notification about a new package, enter the number of days to delay in the **Delay Announcement** field.
5. Enable or disable auto-staging of component firmware by selecting or clearing **Auto-stage library component firmware**. The library does not apply the firmware until you initiate a library update. Enabling auto-staging decreases the time required to complete a library update.
6. Click **Save** to save the new settings.

Configure Rotation Manager

Overview If your site uses NetBackup™ Vault Manager or Symantec™ NetBackup, you can purchase the Rotation Manager option to simplify identifying tapes moved off site. With Rotation Manager installed, the library sends an email for each magazine that is exported (ejected) from the library to a specified email recipient. The email includes the barcode information for the magazine and an attachment that contains the barcode information for the cartridges it contains.

Administrators can follow the instructions in the email they receive to import identifying information for every barcode labeled cartridge and its off-site location into the storage management software. Because the cartridge barcodes are associated with the barcode of the magazine containing the cartridges, groups of cartridges can be located using a single barcode. Refer to the documentation that accompanied your software for information about using the `vltcontainers` command to manage the off-site magazines and cartridges.

Note: Before you can use Rotation Manager, you must enter the activation key to enable it as described in [Enter Activation Keys on page 97](#).

User Privilege Requirements Only a user with superuser or administrator privileges can configure Rotation Manager. See [Understanding User Groups and Security on page 90](#) for information about the three types of user groups and what types of privileges each has.

Configure Rotation Manager Use the following steps to configure the Rotation Manager.

1. Log into the library as a user with superuser or administrator privileges.
2. If necessary, obtain the activation key for Rotation Manager and enable it as described in [Enabling BlueScale Software Support, Options, and Upgrades on page 95](#).
3. From the toolbar menu, select **General ...> Import Export ...> Rotation Manager**. The Rotation Manager Configuration screen displays.



Figure 63 The Rotation Manager Configuration screen.

4. **Symantec NetBackup** is the only vendor supported by Rotation Manager and is selected automatically.

Note: NetBackup Vault Manager was acquired by Symantec and continues to be supported by Rotation Manager even though it is not listed on the Rotation Manager Configuration screen.

5. Select the **Mail To** email address to use for sending notifications.

Only previously configured mail recipients are listed. To send the notification to someone who is not already listed as a library user, you must first configure that person as an email recipient (see [Configure Mail Users on page 106](#)).

6. Click **Save**.

BACKING UP THE LIBRARY CONFIGURATION

Overview Keeping valid backup copies of your library's configuration, the MLM and DLM databases, and BlueScale encryption keys ensures that you can easily restore the library in the event of a disaster. Having a backup of the library's configuration is also extremely useful if problems require you to replace the LCM or the memory card in the LCM. After the replacement procedure is complete, you can use the saved configuration to restore the library's settings, including the partitions, instead of having to manually re-enter all of the information.



Important

Backing up the library configuration also backs up any BlueScale encryption keys that are stored in the library at the time the file is created.



Important

The backup configuration can only be used to restore the library that generated the backup. The configuration is tied to the Hardware ID of the library and cannot be transferred to another library.

Note: If the MLM database contains a large number of MLM and DLM records, generating the Auto Configuration Save file can take several minutes.

Options The library provides two methods for backing up the configuration:

- **Automatic** — See [Use Automatic Backup of the Library Configuration on page 136](#).
- **Manual** — See [Use Manual Backup of the Library Configuration on page 136](#).

If you have valid backups of the library's configuration and MLM database, you can use them to restore the library (see [Restoring the Library Configuration on page 340](#)).

See [Back Up and Protect the Library Metadata on page 455](#) for additional information about backing up the library's configuration information, the MLM database, the DLM database, and any BlueScale encryption keys.

Use Automatic Backup of the Library Configuration

The Auto Configuration Save feature, which operates automatically, saves a backup of the library configuration, the MLM and DLM databases, and any stored BlueScale encryption keys to a time-stamped zip file on the memory card in the LCM. The zip file is named `<date-time>cfg.zip`, where `<date-time>` is the time stamp for when the backup was created. The library generates the Auto Configuration Save backup file once a week and whenever a partition is created or modified.

Note: The library does not generate an Auto Configuration Save backup file when you make configuration changes other than creating or modifying a partition.

As an extra security measure, you can configure the library to automatically email the time-stamped zip file to a previously configured email recipient each time the backup file is created. Saving an external copy of the automatically generated configuration backup file ensures that you can recover the library configuration, the MLM and DLM databases, and the BlueScale encryption keys stored in the library in the event of a disaster.

When the recipient receives the email, they should verify the backup as described in [Verify the Configuration Backup on page 139](#) and [Verify the Database Backup File on page 284](#).

For detailed information about configuring a mail recipient for the Auto Configuration Save file and using it to restore the library, see:

- [Enable Email for the Auto Configuration Save File on page 108](#)
- [Restore From an Auto Configuration Save File on page 341](#)

Use Manual Backup of the Library Configuration

Overview Whenever you make a configuration change to the library that does not result in the library automatically generating a configuration backup file (for example, you entered activation keys after the creation date of the most current automatically generated backup file), you can manually back up the library configuration as described in this section.

Notes: ▪ The Save Library Configuration utility described in this section does not back up the MLM database or the DLM database.

To back up the MLM and DLM databases, use the Save MLM Database utility, as described in [Back Up the MLM and DLM Databases on page 282](#). After you create the backup, be sure to verify it as described in [Verify the Database Backup File on page 284](#).

- Backing up the library configuration also backs up any BlueScale encryption keys that are stored in the library at the time the file is created.

User Privilege Requirements Only a user with superuser or administrator privileges can create a manual backup of the library configuration. See [Understanding User Groups and Security on page 90](#) for information about the three types of user groups and what types of privileges each has.

Back Up the Library Configuration

1. Log into the library as a user with superuser or administrator privileges.
2. If you want to save the configuration to a USB device, connect the device to a USB port on the LCM or the front panel and wait for the device to mount before continuing.

Note: The **save library configuration to USB** option is only available if you connect a USB device to the library before you access the utilities screen (see [Connect a USB Device to the Library on page 158](#)).

3. Select **Maintenance** ...**Tools** ...**Utilities**. The Utilities screen displays a list of Basic Utilities.

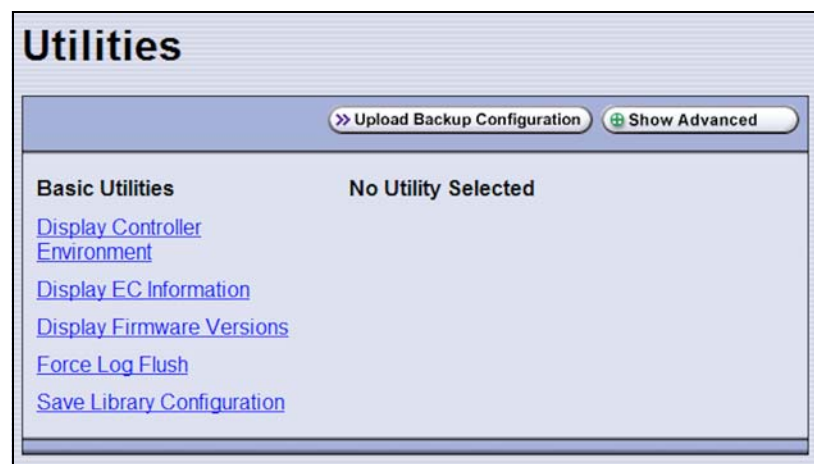

Figure 64 The Utilities screen.

- Select the **Save Library Configuration** utility. The screen refreshes to show the details for the utility.

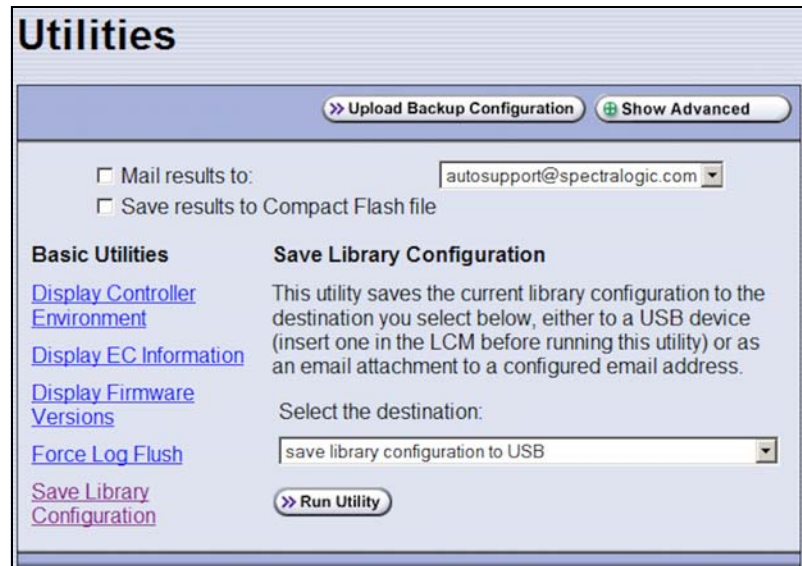

Figure 65 The Save Library Configuration utility.

- Use the **Select the destination** drop-down list to select where you want to save the file.

Note: Do not use the check boxes at the top of the screen. They act on the Utility Results message, not the configuration file.

Select...	To...
save library configuration to USB	Save the library configuration file to the USB device connected to a USB port on the LCM or front panel. The backup file is stored in a folder called <code>SavedConfigs\<i><date-time></i></code> , where <i><date-time></i> is the time stamp for when the backup was created. The folder contains multiple configuration files with the format <code>cnnnnnnn.cfg</code> , where <i>n</i> is a number between 0 and 9.
mail library configuration to [mail recipient]	Send the library configuration file as a zip file attached to an email addressed to a previously configured mail recipient (see Configure Mail Users on page 106). Note: Do not mail the file to <code>autosupport@spectralogic.com</code> unless Spectra Logic Technical Support specifically requested the file for troubleshooting.

- Click **Run Utility**.

After a brief delay, the Utility Results screen displays, showing that the configuration file was either saved or sent.

- Confirm that the backup was successful, as described in [Verify the Configuration Backup](#).

Verify the Configuration Backup

After creating a backup of your library configuration, use one of the methods described in the following sections to verify that the backup was successful as soon as possible after you create it.

When Saved to a USB Device

1. Plug the USB device into a USB port on an available computer.
2. Examine the list of files on the USB device and locate the `\SavedConfigs` folder.
3. Open the `\SavedConfigs` folder and verify that a folder with a name corresponding to the date and time you created the backup is present.
4. Open the time-stamped folder and confirm that it contains several configuration files named using the format `cnnnnnnn.cfg`, where *n* is a number between 0 and 9. Make sure the files are more than 0 bytes in size.
5. If the configuration files are present and are more than 0 bytes in size, the backup was successful. Store the USB device in a safe location.

Note: You can zip the files in the folder and email the zip file to others or make additional copies of the folder for safekeeping.

6. If the configuration files are not present, or if any of the files are 0 bytes in size, repeat the backup process ([Use Manual Backup of the Library Configuration on page 136](#)) using a different USB device.

When Sent as an Email Attachment

1. Open the email and confirm that it contains a zip file attachment.
2. Open the zip file and confirm that it contains several configuration files named using the format `cnnnnnnn.cfg`, where *n* is a number between 0 and 9. Make sure the files are more than 0 bytes in size.
3. If the configuration files are present and are more than 0 bytes in size, the backup was successful. Save the zip file attachment to a safe location from which you can copy it to a USB device, if needed.

Note: If desired, rename the zip file to indicate the date of the backup.

4. If the email attachment does not contain the configuration files or if one or more of the files are 0 bytes in size, repeat the backup process ([Use Manual Backup of the Library Configuration on page 136](#)) to send the email again.

Read [Back Up and Protect the Library Metadata on page 455](#) for additional information about backing up the library's configuration information, the MLM and DLM databases, and BlueScale encryption keys (this information is collectively referred to as the library metadata).

CHAPTER 5

Operating the Library

This chapter describes the following procedures for day-to-day operation of your library:

Topic	
Controlling the Library Power	page 141
Power On the Library	page 141
Power Off the Library	page 143
Monitoring Your Library	page 145
Check and Respond to Messages	page 146
Use Performance Metrics	page 149
View Robot Utilization Information	page 152
View Drive Status Information	page 153
View a Partition's World Wide Name	page 156
Using a USB Device	page 157
Using a USB Device	page 157
Continuing Backups While Using a USB Device	page 157
Connect a USB Device to the Library	page 158
Plug the USB device into the USB port and allow time for the device to mount.	page 158

CONTROLLING THE LIBRARY POWER

The library power is controlled using the operator panel power button or the BlueScale Soft Power feature.

Power On the Library

Before powering on the library, make sure that all of the library's power cables are plugged into AC outlets and that the AC breaker switches corresponding to each cable, on the back of the main frame and each drive expansion frame, are set to the **on** (up) position.



Important

For redundant AC power configurations, connect the primary and secondary input for each frame to a separate branch circuit, which allows for failover in the event of a power failure in one of the circuits (see [Power Specifications on page 479](#) for additional requirements).

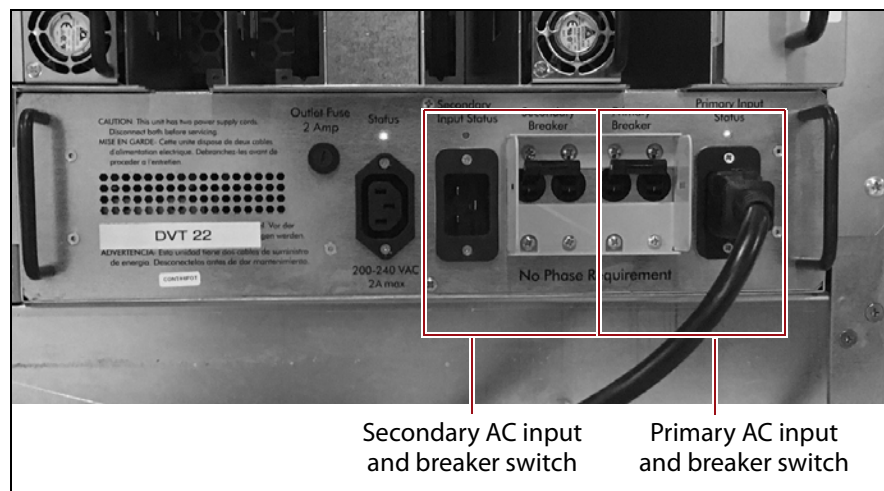

Figure 66 Connect the AC inputs and set the breaker switches to the **on** position (dual AC module shown).

Use the Front Panel Power Button

1. Press and hold the front panel power button until the button's LED illuminates and the LCD operator panel turns on.

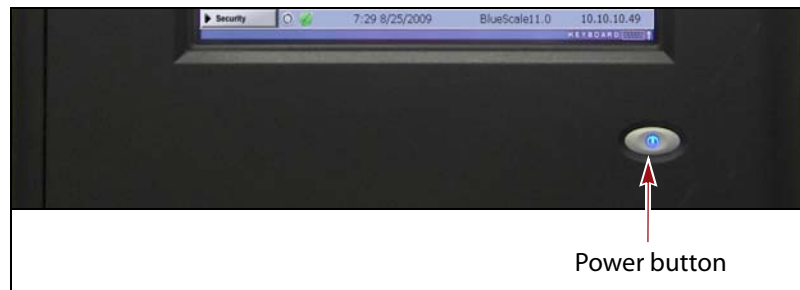

Figure 67 Press and hold the front panel power button.

2. Wait while the library completes its power-on sequence. After the library completes its power-on sequence, the Library Initialization screen displays (see [Figure 33 on page 82](#)). This screen lists the required initialization steps and current status of the library's major components (Robotics, RCM, and LCM). Text boxes provide descriptions about the currently active tasks.
3. After initialization is complete, the BlueScale login screen displays (see [Log Into the User Interface on page 82](#)).

Note: If the library cannot complete the initialization process, it generates system messages and enters maintenance mode. Contact Spectra Logic Technical Support for assistance (see [Contacting Spectra Logic on page 7](#)).

Use the Automatic Power-Up After Power Failure Feature

The Automatic Power-Up After Power Failure feature lets you configure the library to power on without user intervention after a power failure.

- Notes:**
- The Automatic Power-Up After Power Failure feature must be enabled on the System Setup screen (see [Enable Automatic Power-Up After Power Failure on page 101](#)).
 - The library does not automatically power on if it was powered off using the front panel power button or the Soft Power feature.

Power Off the Library

Before powering off the library, use the following steps to prepare for shut-down.

1. Use your storage management software to stop any backups running to the library.
2. Pause PostScan if it is running (see [Pause the PostScan Process on page 272](#)). Any tapes currently being scanned are returned to their storage locations.
3. Power off the library using one of the methods described in the following sections.

Note: If you intend to leave the library powered down for an extended length of time, set the AC breaker switches on the back of the library (see [Figure 66 on page 141](#)) to the **off** position after you power off the library.

Use the Front Panel Power Button

To power off the library, press and hold the front panel power button for approximately 5 seconds (the button's LED starts flashing). The library begins its power-off sequence, which allows the BlueScale software and components to shut down gracefully.

Use the Soft Power Feature

The Soft Power feature disables the physical power button on the library front panel and enables the soft power button on the General Status screen. Using the Soft Power feature gives users with superuser privileges exclusive control over powering the library off; other types of users cannot power off the library, either by using the physical power button on the library front panel or the Soft Power button on the General Status screen.

- Notes:**
- The Soft Power feature is only available from the library's front panel touch screen interface; it is not available through the BlueScale web interface (RLC).
 - When you click the Soft Power button, you must respond to a confirmation message before the library is powered off.
 - The Soft Power feature must be enabled on the System Setup screen before you can use it (see [Enable Soft Power on page 102](#)).
 - The feature can only be enabled or disabled by a superuser.

Follow these steps to power off the library using the Soft Power feature.

1. Log into the library as a user with superuser privileges (see [Log Into the User Interface on page 82](#)).
2. From the toolbar, access the General Status screen.

- Using the stylus, touch the blue power button on the picture of the library.

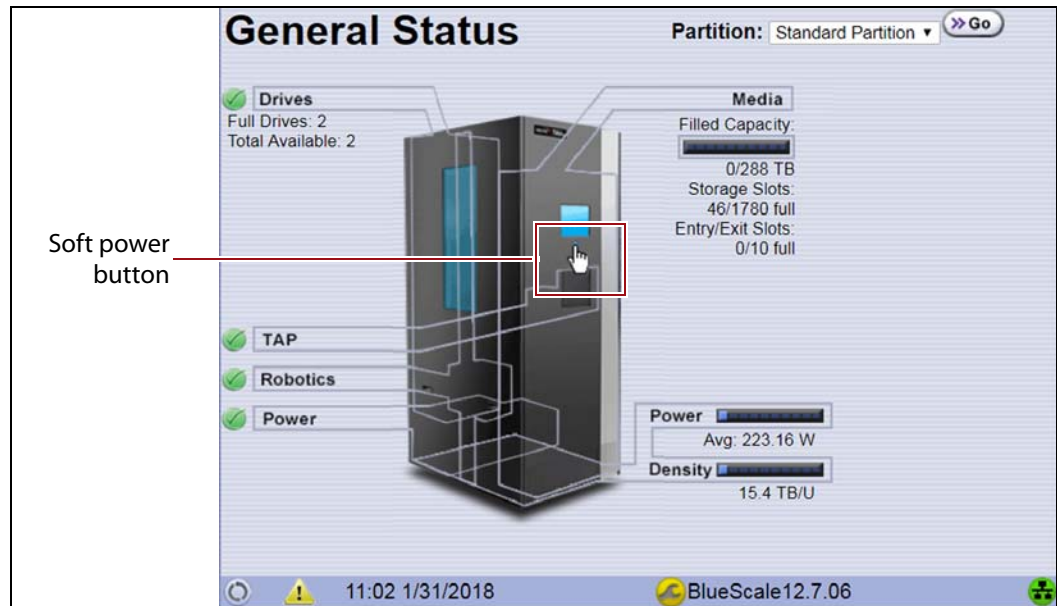

Figure 68 The Soft Power button on the General Status screen.

When the cursor comes near the button, it changes to a pointing finger, as shown in [Figure 68](#).

- When you touch the button, the Soft Power Shutdown confirmation screen displays after a brief delay. Click **Continue** to power off the library.

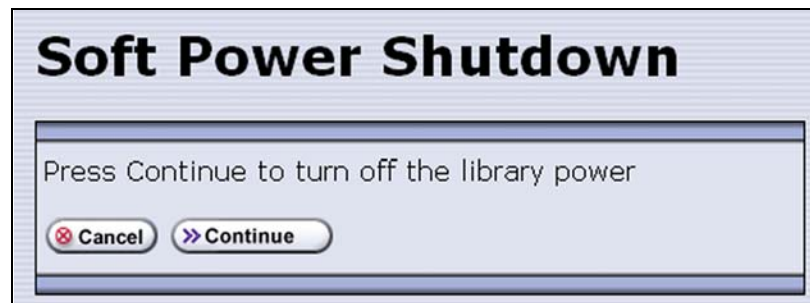

Figure 69 The Soft Power Shutdown confirmation screen.

MONITORING YOUR LIBRARY

Overview The BlueScale user interface provides a number of tools for monitoring the health and performance of the library, its components, and its media. The quickest way to obtain important information is to check the icons and bar graphs on the General Status screen (see [Status Bar on page 78](#)). They provide at-a-glance information about the status of major system components and resource usage, respectively. The icons on the status bar provide additional system-level status information.

The following table lists where to find additional information about the health and performance of the library, its components, and its media.

Check...	To monitor...	For details, see...
System Messages	Events that resulted in system messages about the library and its operation.	Check and Respond to Messages below
Performance Metrics	The performance of your library and its drives.	<ul style="list-style-type: none"> ▪ View Drive Performance Statistics on page 149 ▪ View Power Consumption Statistics on page 151 ▪ View Storage Density Statistics on page 151
Robot Utilization Information	The percentage of time the robotics are being used while the library is powered on.	View Robot Utilization Information on page 152
Drive Status	The operational status, firmware level, and cleaning status of the drives.	<ul style="list-style-type: none"> ▪ View Drive Status Information on page 153 ▪ Using a Global Spare Drive on page 352
Media Lifecycle Management (MLM)	The usage and health of MLM-enabled media in the library. Note: MLM also provides limited health information about media that is not MLM-enabled.	Chapter 9 – Configuring and Using Media Lifecycle Management, beginning on page 243
Drive Lifecycle Management (DLM)	The usage and health of the LTO drives in the library.	Chapter 10 – Using Drive Lifecycle Management, beginning on page 288
Hardware Health Monitoring	The health of key library components.	Using BlueScale Hardware Health Monitoring on page 324

User Privilege Requirements All users can view system messages and view performance metrics. The user privileges required to use the other monitoring tools depend on the tool.

Check and Respond to Messages

Check the library's system messages regularly. These messages provide important information about the library, its operation, and any library problems. Reviewing the messages is the first step in troubleshooting.

Note: When you configure mail users, you can specify which types of system messages the library automatically emails to each mail user. See [Configure Mail Users on page 106](#) for detailed information.

Use the BlueScale User Interface

Use the following steps to view BlueScale system messages through either the operator panel or a web browser.

1. Log into the library.
2. Select the System Status icon on the status bar (see [Figure 29 on page 78](#)). The System Messages screen displays.



Figure 70 The System Messages screen.

The following table describes the severity ranking for messages.

Message Severity	Description	Response
Informational	The library is working as intended. An event occurred that generated information about an operation or a system component. Example: The utility completed successfully.	No action is required.
Warning	The library is working as intended. An event occurred that may require attention to keep the library running at 100%. Example: QuickScan did not complete, but will retry.	If the event was unexpected, determine the cause of the event and take remedial steps.
Error	The library operation is impaired and requires user intervention. Example: QuickScan did not complete, and there is a tape stuck in a drive as a result.	Determine the cause of the error and take remedial steps.
Fatal Error	The library experienced an event that prevents it from continuing operations. Example: The robot is not responding.	Examine any additional information in the message and take the required remedial steps.

3. Read the message(s), and follow any recommended steps.

Note: Some error messages are followed by a series of errors that provide additional information. To understand the sequence of events, scroll back to view the first error message that was produced, then read the others for clarification.

If you need assistance, contact Spectra Logic Technical Support (see [Contacting Spectra Logic on page 7](#)).

4. When you are finished reading the messages and complete the appropriate actions, you can select and delete individual messages or you can delete all of the messages.

Use Syslog

The BlueScale Syslog feature sends all system messages logged by the library to a previously configured Syslog server. Syslog is a standard for forwarding log messages over an Internet Protocol (IP) computer network. It provides separation of the software that generates log messages from the system that stores the messages.

Each system message the library sends to the Syslog server contains the original system message posted by the library and the remedy information associated with the system message.

See [Syslog Server IP Address on page 103](#) for information about entering the IP address of the Syslog server. Entering a valid IP address enables the Syslog feature.

When enabled, the BlueScale Syslog feature automatically sends all system messages posted by the library to a single, previously configured Syslog server. The library transmits the messages to the Syslog server using the format:

```
<severity level>BlueScale_<library name>[PP]:(<message number>)  
<message text>
```

where:

Variable	Definition	
severity level	Indicates the severity the library assigned to the message. This severity corresponds to the syslog priorities as follows:	
	This library system message severity...	Corresponds to this Syslog priority...
	Informational	6 (Informational)
	Warning	4 (Warning)
	Error	3 (Error)
	Fatal Error	2 (Critical)
library name	The name of the library, if configured. If the library name is not configured, this value is set to "UnknownLibrary." Refer to Library Name on page 100 for information about setting the library name.	
PP	Indicates the ID number of the process that was being performed by the library's BlueScale software when the system message was posted. This ID number is for internal use only.	
message number	Indicates the order in which the Syslog server received the messages. The counter increments each time a message is received, beginning at zero. The counter can be used to determine whether all messages are arriving at the Syslog server.	
message text	Shows the actual message posted by the library. Each system message posted by the library generates two Syslog messages; one for the message text and one for the remedy text. The two messages have the same message number, which is included at the beginning of the message.	

Use Performance Metrics

The library includes the following metrics for monitoring the performance of your library and its drives.

- [View Drive Performance Statistics](#) on this page
- [View Power Consumption Statistics](#) on page 151
- [View Storage Density Statistics](#) on page 151

View Drive Performance Statistics

The Drive Performance metrics let you monitor the performance of your drives. This innovative feature helps you optimize drive performance through load-balancing, tuning your SAN, and identifying performance bottlenecks.

Note: The Drive Performance Monitoring option is disabled by default. [Enable Drive Performance Monitoring on page 101](#) provides instructions for enabling this option.

Use the following steps to view the performance data.

1. Select **General**  **Metrics** from the toolbar menu. The screen for the last metric you viewed displays.
2. Select how you want to view the performance information from the available options:
 - **Total Library** — The consolidated statistics for all the drives in the library.
 - **Partition *n*** — The statistics for the drives in the specified partition.
 - **Drive *n*** — The statistics for a specific drive.
3. Select either **Drive Write Performance** or **Drive Read Performance** from the **Metric** drop-down menu.

Note: If you enabled or disabled the Drive Performance Monitor option when a drive contained a cartridge, the drive is reported as empty on the Drive Performance screens.

- Click **Go**. A screen showing the selected metric displays.

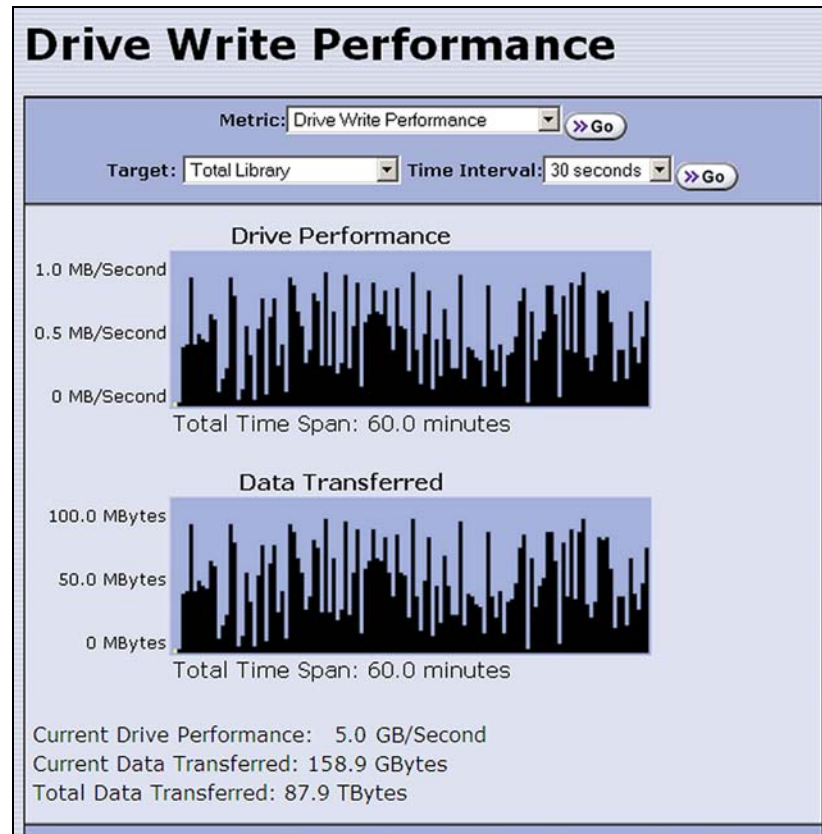

Figure 71 The Drive Performance Monitor screen (Write Performance for the Total Library shown).

- Alternatively, you can view the Drive Performance metrics by selecting **Configuration >> Drives (or DLM)** and then clicking **Drive Performance**.

Note: The **Drive Performance** button is not present if Drive Performance Monitoring is not enabled (see [Enable Drive Performance Monitoring](#) on page 101).

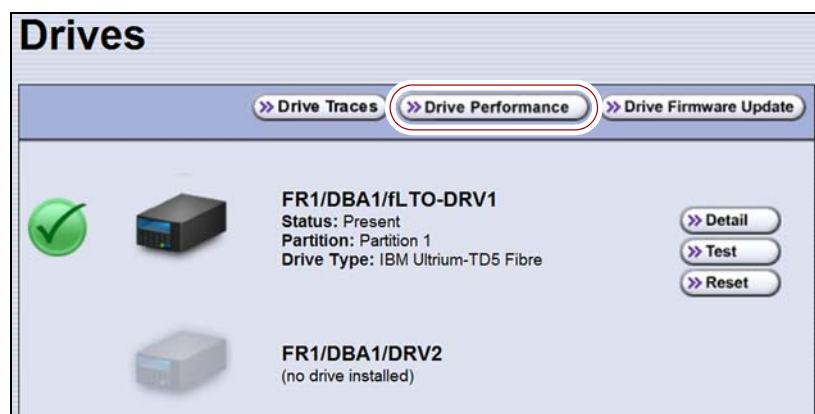



Figure 72 The Drives screen.

View Power Consumption Statistics

In addition to the Power bar graph on the General Status screen, the BlueScale EnergyAudit feature provides a configurable graphical display of the library's power consumption.

Use the following steps to view the power consumption data for the library.

1. Select **General**  **Metrics** from the toolbar menu. The screen for the last metric you viewed displays.
2. Select which power consumption metric you want to view from the **Metric** drop-down menu:
 - Power Consumption (kWh)
 - Power Consumption (kWh/Ft²)
 - Power Consumption (kWh/Ft³)
 - Power Consumption (kWh/TB)
3. Click **Go**. A screen showing the selected metric displays.

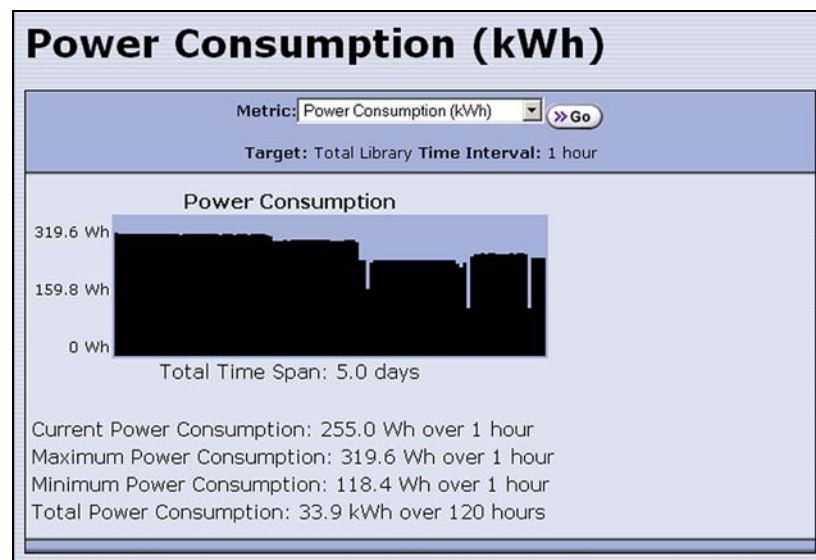



Figure 73 The Power Consumption metrics screen.

View Storage Density Statistics

The Storage Density metrics let you monitor the amount of data your library is capable of storing based on the number of data cartridges currently stored in the library.

Use the following steps to view the storage density data for the library.

1. Select **General**  **Metrics** from the toolbar menu. The screen for the last metric you viewed displays.
2. Select **Storage Density** from the **Metric** pull-down menu.
3. Select the media type and the unit of measure for the density values.

4. Click **Go**. The Storage Density screen showing the selected metrics displays.

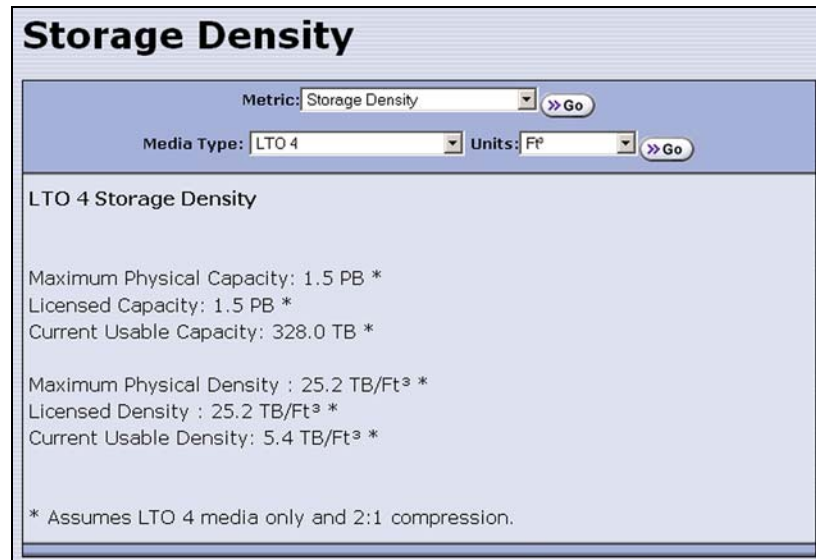

Figure 74 The Storage Density metrics screen.

View Robot Utilization Information

The Robot Utilization by Hour metric lets you monitor the percentage of each hour that the library's robotics are actively operating over the last 24 hours. The data is updated every hour while the library is powered on.

- The Robot Utilization by Hour metric can include up to 24 data points, one for each hour that data was collected over a 24-hour period. The first time period begins one full hour after the library is powered on. Data collected during the first partial hour following power-on is discarded as invalid data.
- The data is stored in volatile memory and is not retained when the library is powered off.

Use the following steps to view the robot utilization information.

1. Select **General** ... **General Status** from the toolbar menu. The General Status screen displays.
2. Click **Robotics** to display the Robotics Status screen.

3. Select the **Usage** tab to display the Robot Utilization by Hour metric.

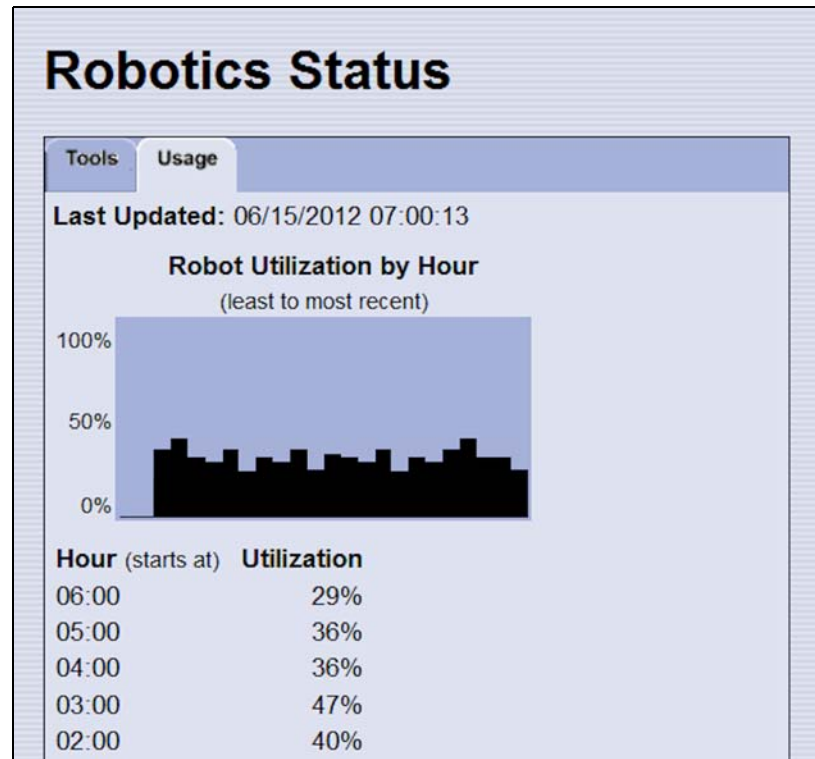

Figure 75 The Robotics Status screen.

View Drive Status Information

The drive status icon on the General Status screen indicates the overall status of the library's drives. If the status icon indicates that a drive is experiencing a problem, view the Drive and Drive Details screens for detailed information about a specific drive.

The Drive Details screen includes the drive firmware version and the manufacturer's serial number, as well as more detailed status information. From the Drive Details screen you can access the Drive Lifecycle Management (DLM) report for the drive. See [Chapter 10 – Using Drive Lifecycle Management](#), beginning on [page 288](#) for detailed information about DLM.

Use the following steps to view information about the individual drives in the library.

1. Log into the library as a user with administrator or superuser privileges.
2. Select **Configuration** > **DLM** (or **Drives** if DLM is not enabled) to display the Drives screen. This screen lists all of the drives in the library, along with basic information about each drive and the available operations for each drive.

Note: The operations available for each drive depend on how you are accessing the BlueScale user interface and whether or not:

- DLM is enabled
- The drive is configured in a partition
- Auto Drive Clean is enabled for the partition

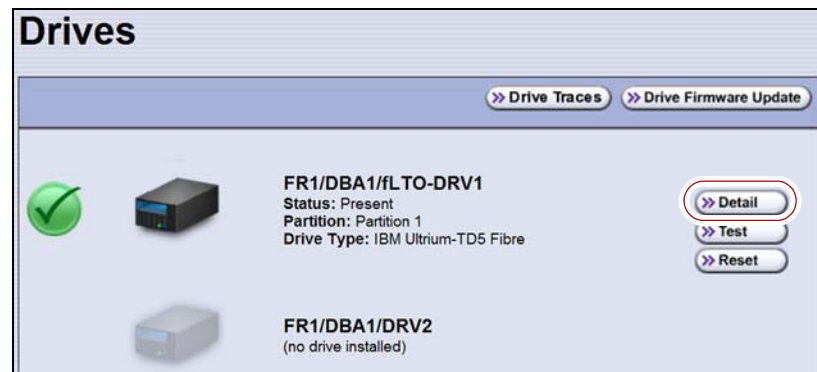

Figure 76 The Drives screen.

3. Click **Detail** next to the drive for which you want to view detailed information. The Drive Details screen displays.

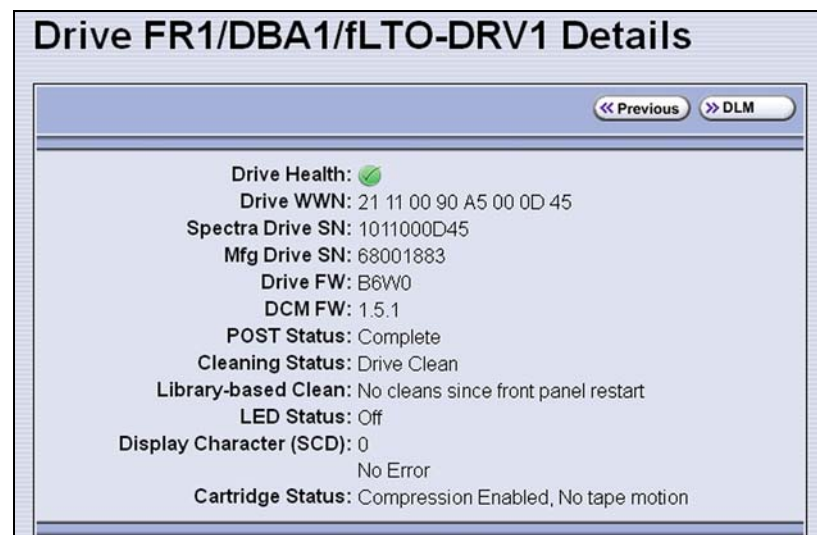

Figure 77 The Drive Details screen.

The Drive Details screen shows the following information.

This field...	Shows...
Drive Health	The drive health icon (see Using the Drive Health Icons on page 291).
Drive WWN	The Fibre Channel WWN for the drive (see World Wide Names for Fibre Channel Drives on page 65 for detailed information about the WWNs for drives) or the SAS port identifier for a SAS drive.
Spectra Drive SN	The location-based serial number for the drive while it is in the library. This serial number makes it possible to replace one drive with another without having to reconfigure the storage management software that accesses the drive. Note: For TS11xx technology drives, the serial number provided in response to SCSI commands from the host has 00 appended to the end of the number that displays on the operator panel or is retrieved using XML.
Mfg Drive SN	The serial number assigned to the physical drive by the drive manufacturer. This serial number is required for tracking the drives when they are not inside the library.
Drive FW	The firmware version being used by the drive itself.
DCM FW	The firmware version being used by the drive sled that houses the drive.
POST Status	Shows the results of the drive's POST (Power-On Self-Test).
Cleaning Status	Shows the status of the drive's Cleaning Tape Alert flag.
Library-based Clean	Shows the last time that the drive was cleaned using the Auto Drive Clean feature. Note: This field is only present when a cleaning partition is associated with the storage partition containing the drive.
LED Status	Shows the state of the drive's front panel status LED (see Interpreting the Status LED Information on page 366).
Display Character (SCD) or Display Message (MCD)	Shows the code displayed on the drive's single-character display (SCD) or multi-character display (MCD) (see Interpreting the SCD and MCD Codes on page 366).
Cartridge Status	Indicates whether the drive is configured to compress data as it is written and whether the drive contains a cartridge. Note: No tape motion indicates either that the drive is empty or, if the drive contains a cartridge, that the tape is not moving.

- From the Drive Details screen click **DLM** to access the Drive Lifecycle Management (DLM) report for the drive (see [Viewing and Saving a Detailed Drive Health Report on page 293](#)).
- Use the information on the Drive Details screen and the DLM report to troubleshoot drive problems (see [Troubleshooting Drives on page 362](#)). If the drive is in an error state, contact Spectra Logic Technical Support (see [Contacting Spectra Logic on page 7](#)).

View a Partition's World Wide Name

When monitoring connections to multiple libraries through a Fibre Channel switch, knowing the World Wide Name (WWN) for a storage partition is useful for identifying a particular library.

Note: From the Fibre Channel switch, each storage partition defined in the library appears as an independent library connected to the Fibre Channel arbitrated loop or fabric.

To view the WWN for each storage partition configured in the library, select **Configuration > Partitions**. The Shared Library Services screen displays.

Note: If multiple drives are configured as exporting controllers in a partition there are multiple WWNs for the partition. Click **Summary** to display the Partition Settings screen, which lists all of the WWNs.





Figure 78 The WWN assigned to the partition.

See [World Wide Names for Fibre Channel Partitions](#) on page 62 for detailed information about the partition's WWN.

USING A USB DEVICE

You can plug a USB device into the USB port on the library's operator panel or into a USB port on the LCM for transferring information such as backing up or restoring the library configuration, backing up or restoring the MLM and DLM databases, importing or exporting BlueScale encryption keys, gathering log files, or to upload BlueScale software updates to the library.

 **Important** After connecting a USB device, allow time for the device to mount before continuing.

 **Important** Do not leave a USB device plugged into the library control module indefinitely, unless specifically directed to do so by Spectra Logic Technical Support.

One Spectra Logic USB device is shipped with the library, but most types of USB devices work.

 **Important** The library only recognizes FAT-formatted, not NTFS-formatted, USB devices. If you are unable to access a USB device from the library, remove it and use a different one.

Continuing Backups While Using a USB Device

When using a USB device, keep the following requirements in mind:

It is...	to continue backups while...
Safe	Exporting or importing a BlueScale encryption key to a USB device.
	Saving library configurations and other information to a USB device.
	Capturing traces and saving the trace results data to a USB device.
Not Safe	Restoring a saved library configuration and other information from a USB device.
	Updating the library BlueScale software using an update package on a USB device.

Connect a USB Device to the Library



Important

Unless specifically instructed to do so, do not connect a USB device to the USB port on the RCM.

- Notes:**
- When connecting the USB device to the LCM, make sure that you do not inadvertently connect it to the RCM. See [Figure 10 on page 41](#) to identify the LCM.
 - The library only recognizes FAT-formatted, not NTFS-formatted, USB devices.
 - Not all USB devices are compatible with the library. If you are unable to access a USB device from the library, remove it and use a different one. If the LCM stops responding after you insert an incompatible USB device, reboot the LCM as described in [Reset the LCM or RCM on page 334](#).
 - Plug the USB device into the LCM *before* beginning a procedure that reads or writes data to allow time for device recognition. For many utilities, the option to read from or write data to a USB device is not available if a USB device was not plugged into the LCM and allowed enough time to mount before you select the utility.

Use the following steps to connect a USB device to the library.

1. Locate the USB port you want to use on the operator panel or LCM.
2. Plug the USB device into the USB port and allow time for the device to mount.

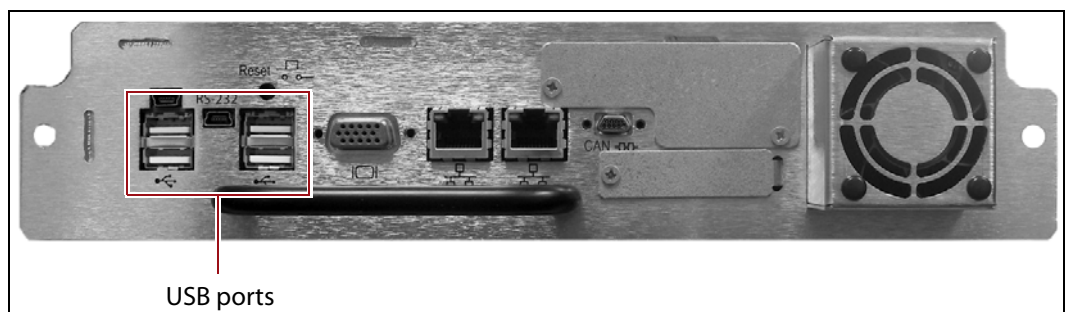

Figure 79 Location of the USB ports on the Spectra LS.

CHAPTER 6

Configuring and Managing Partitions

This chapter describes how to use the BlueScale partition wizard to configure and manage partitions in the library.

Topic	
Partition Configuration Overview	page 160
Partition Types and Requirements	page 160
Preparing to Configure Partitions	page 165
Creating a Cleaning Partition	page 166
Define the Initial Cleaning Partition Settings	page 167
Configure the Chambers for the Partition	page 168
Creating a Storage Partition	page 169
Define the Initial Storage Partition Settings	page 169
Select the Robotic Control Path	page 172
Assign Global Spare Drives	page 173
Allocate Chambers and Drives	page 176
Enable and Configure MLM PreScan and PostScan	page 178
Select the Encryption Mode	page 181
Configure the Drive Fibre Channel Addressing	page 183
Specify the Partition Users	page 184
Configure the Robotic Path Visibility	page 184
Configure the Port Addressing for the Controllers	page 185
Configure the Port Addressing for the Controllers	page 185
Confirming and Saving the Partition Settings	page 187
Modifying an Existing Partition	page 190
Deleting a Partition	page 194

PARTITION CONFIGURATION OVERVIEW

Before you start configuring partitions in your library, it may be helpful to read the following:

- [Media Pools](#), beginning on [page 49](#), to understand how the storage chambers in the library are allocated.
- [Library Partitions](#), beginning on [page 50](#), to learn how the library uses storage partitions to create multiple virtual libraries.
- [MLM PreScan and PostScan on page 250](#) to learn how the MLM PreScan and PostScan features interact with the storage partitions.

Partition Types and Requirements

The library supports two types of partitions: storage partitions and cleaning partitions. When configuring partitions, keep in mind the requirements in the following sections.

Global Considerations

The following information applies to both cleaning and storage partitions.

User Privilege Requirements Only users with superuser or administrator privileges can create or modify partitions.

Background operations You cannot create, modify, or delete a partition if the library is actively running a Media Auto Discovery, PreScan, or PostScan operation, or if the library is performing certain other background processes (for example, updating drive firmware using the Update Drive Firmware wizard).

If you do not want to wait for a Media Auto Discovery, PreScan, or PostScan operation to complete, you can stop the Media Auto Discovery or PreScan operation or pause the PostScan operation. For other background operations, wait for the process to complete.

- To stop Media Auto Discovery or PreScan, click **Stop Discovery** on the Media Lifecycle Management Tools screen (see [Stop the Discovery Process on page 264](#)).
- To pause PostScan for one hour, click **Pause PostScan** on the Media Lifecycle Management Tools screen (see [Pause the PostScan Process on page 272](#)).

Configuring and Using Cleaning Partitions and Auto Drive Clean

Cleaning Partition Overview A cleaning partition provides permanent storage for cleaning cartridges inside the library. This special-purpose partition is only used when Auto Drive Clean is enabled for one or more storage partitions and can be shared by multiple storage partitions. The cleaning partition does not have any drives associated with it.

Configuring a cleaning partition does not require an SLS activation key; nor does a cleaning partition count against the partition maximum for the library. If fewer than the physically present chambers are licensed with a Capacity On Demand (CoD) key, the cleaning partition uses any chambers that are not licensed. The chambers assigned to the cleaning partition do not count against the licensed capacity. If all of the physically present chambers are licensed, the cleaning partition can use any chambers that were not already assigned to another partition.

Auto Drive Clean Functional Overview Auto Drive Clean uses the cleaning cartridges stored in the cleaning partition to provide automatic, library-based cleaning of LTO drives without user intervention. Automated drive cleaning results in fewer failed tape read/write operations and is the preferred method for cleaning drives. See [Cleaning Cartridge Tracking on page 249](#) for information about how Media Lifecycle Management (MLM) manages the cleaning cartridges in the cleaning partition.

Note: Drive cleaning operations that are initiated by the storage management software cannot use the cleaning cartridges stored in a cleaning partition; the cartridges are not accessible to the storage management software.

When the drive is unloaded in response to a host request and the data cartridge is moved to its storage location, the library queries the drive to determine if it needs cleaning. If cleaning is required, the library delays notifying the host that the SCSI move command for the unloaded data cartridge is complete while it performs an automatic drive cleaning.

During the delay, the library retrieves a cleaning cartridge from the cleaning partition and inserts it into the drive. When the cleaning is complete, the library returns the cleaning cartridge to the cleaning partition and then notifies the host that the SCSI move command for the unloaded data cartridge is complete.

Automatic cleaning of drives does not occur more than once in any 12 hour period. If the next data cartridge load/unload cycle occurs within this 12 hour waiting period, a cleaning is not attempted unless the previous cleaning attempt failed due to an expired cleaning cartridge. When a cleaning fails, the cleaning is reattempted the next time the host unloads a data cartridge from the drive if the cleaning partition contains a good cleaning cartridge. If you want to clean the drive immediately after you receive the notification that a cleaning failed, you can initiate a manual cleaning (see [Manually Cleaning a Drive on page 416](#)).

Configuration Requirements for a Cleaning Partition and Auto Drive Clean

- Cleaning partitions do not count against the partition maximum.
- A cleaning partition can be shared by multiple storage partitions as long as the cleaning cartridges are compatible with the drive types in each storage partition.
- Cleaning partitions use chambers that are not licensed with a Capacity On Demand (CoD) key. If all of the chambers are licensed, a cleaning partition uses any chambers that are not already assigned to another partition.
- Configuring a cleaning partition and assigning it to one or more storage partitions automatically enables the Auto Drive Clean feature for those storage partitions (see [Creating a Cleaning Partition on page 166](#) and [Allocate Chambers and Drives on page 176](#)).
- The drives in the storage partitions with an associated cleaning partition are cleaned automatically when a drive indicates that it needs cleaning. In addition, you can use the BlueScale user interface to initiate a manual cleaning. See [Manually Cleaning a Drive on page 416](#).
- The option to perform a manual cleaning operation using a cleaning cartridge in a cleaning partition is only available for drives that are in storage partitions associated with a cleaning partition.
- The cleaning cartridges in the cleaning partition are inaccessible to the storage management software. If your storage management software supports automated drive cleaning and you plan to use this method to clean the drives, store a TeraPack magazine (not a Maintenance TeraPack magazine) containing one or more cleaning cartridges in the storage partition. The storage management software can then access the cleaning cartridges when needed.



Important

If you store cleaning cartridges in the storage partition, make sure that they are identified as required by your storage management software to prevent the storage management software from attempting to use the cartridges for writing or reading data.

- The cleaning cartridges used in a cleaning partition must be stored in specially labeled Maintenance TeraPack magazines.
- If you do not configure a cleaning partition and associate it with the storage partitions, you must use your storage management software to perform the cleaning or use the BlueScale user interface to manually move a cleaning cartridge to the drive that needs cleaning (see [Manually Cleaning a Drive on page 416](#)).
- If you configure a Global Spare drive for a partition, it is cleaned using a cleaning cartridge stored in the cleaning partition. If a cleaning partition is not associated with the storage partition, the Global Spare drive must be cleaned manually (see [Manually Cleaning a Drive on page 416](#)).

Configuring and Using Storage Partitions

- You can configure storage partitions either before or after you configure cleaning partitions. However, if you know that you want to use Auto Drive Clean with a storage partition, it is easier to configure the cleaning partition before you configure the storage partition. If you choose to create the storage partition before you create the cleaning partition, you need to modify the storage partition to assign the cleaning partition to it (thereby enabling Auto Drive Clean for the partition).
- The library requires, at a minimum, one storage partition to be configured before you can use the library. Each storage partition must have a minimum of one chamber assigned to the storage pool. Each storage partition must also have at least one drive assigned to it.
- When using multiple tape technology generations, Spectra Logic strongly recommends configuring separate partitions for each generation.
- When using both Fibre Channel and SAS drives in the library, the different drive interface types must be in separate partitions.
- **Chamber Availability** — The number of chambers available for a storage partition depends on how many chambers in the library are licensed, how many chambers are used by other partitions, and whether or not Thin Provisioning is enabled.
 - If Thin Provisioning is not enabled, the library automatically makes any licensed chambers that are not already configured for use in another partition available to be configured in the new partition. If all of the licensed chambers in your library are already assigned to existing partitions, you must modify one or more partitions to make chambers available for creating a new partition (see [Modifying an Existing Partition on page 190](#)). You may also be able to license more chambers or make hardware upgrades that increase the storage capacity of the library (see [Hardware Expansion and Upgrades on page 471](#)).
 - If Thin Provisioning is enabled, up to a combined total of 20,000 elements, including storage slots (not chambers), entry/exit slots (not chambers), and drives are available for each partition, no matter how many chambers are licensed or already assigned to existing partitions. Using Thin Provisioning, it is possible for the combined configured number of storage slots in all partitions to exceed the licensed or physically available number of slots. Empty slots are inaccessible elements until a TeraPack magazine is imported into a partition. At that time, the slots are made accessible to only the partition into which the magazine was imported.

- **Restrictions on the Number of Partitions** — By default, you can only create a single storage partition. If you need additional storage partitions, you must purchase a Shared Library Services (SLS) activation key. Refer to [Enabling BlueScale Software Support, Options, and Upgrades on page 95](#) for information about purchasing and entering activation keys. Libraries can have a maximum of 16 storage partitions.
 - Notes:**
 - Cleaning partitions do not require an SLS activation key and do not count toward the partition maximum.
 - The more partitions in a library, the longer each move can take. If move requests can be sent to several partitions at once, you may need to increase the timeout setting in your storage management software.
- **Restrictions on Exporters** — Each partition is exported by an RIM2 or a drive.
 - The maximum number of physical exporting devices (drives or RIM2) supported by the library is six. If the library contains RIM2s in excess of the six exporters, the additional RIM2s can be used for failover (see [Controller Failover on page 66](#)).
 - Notes:**
 - If the library only uses drive exporters, multiple exporters may reduce the maximum number of partitions possible. Six drive exporters can be used for six different partitions, or multiple exporters can be configured in the same partition, reducing the maximum number of partitions.
 - A single RIM2 can export up to 16 partitions, but still only count as one exporter.
 - If desired, you can configure multiple exporting controllers of similar type (RIM2s or drives) to a single partition and use your host software to export the same changer interface over the controllers to provide redundancy.
 - Note:** A single partition can have, at most, six physical exporting devices configured.

PREPARING TO CONFIGURE PARTITIONS

Before you begin configuring partitions, gather the information listed in the following table.

Note: Each chamber holds a single magazine.

Component	Description
Media type	<p>Determine the type of media (for example, LTO or LTO Clean) to be used in the partition. You can only select from media types that are compatible with the drives already installed in the library. If there are multiple drive technologies installed in the library, the media type you select determines the type of drive that can be used in the partition. Selecting a “Clean” media type starts the process of creating a cleaning partition for use with the specified media type.</p> <p>Note: Only one media type can be used in each partition. Each media type has its own unique TeraPack magazine and TeraPack barcode.</p>
Cleaning partition: number of chambers	<p>If you plan to use the Auto Drive Clean feature, determine the number of chambers to be used for the cleaning partition. A cleaning partition can be shared by multiple storage partitions as long as the cleaning cartridges are compatible with the drives in the storage partitions. See Configuring and Using Cleaning Partitions and Auto Drive Clean on page 161 for information about using cleaning partitions.</p>
Entry/Exit pool: number of chambers	<p>Determine the number of chambers to be used for the partition’s entry/exit pool. See Entry/Exit pool on page 49 for information about how the entry/exit pool is used.</p>
Storage pool: number of chambers	<p>Determine the number of chambers to be used for the partition’s storage pool. See Storage pool on page 50 for information about how the storage pool is used.</p>
Drives assigned to the storage partition	<p>Determine which drives to assign to the partition. Only drives that are already installed in the library and are compatible with the media type you select are available. Each storage partition must have at least one drive assigned to it.</p>
Global Spares	<p>Determine which drives to designate as Global Spares if you plan to use this feature. See Assign Global Spare Drives on page 173 for detailed information about the requirements for using Global Spares.</p> <p> Important: If you plan to use one of the PostScan features that uses a Global Spare, one or more Global Spare drives must be configured for the partition.</p>
PreScan and PostScan	<p>Decide whether or not you want the library to scan the cartridges in the partition for media errors. See Using PreScan on page 264 and Using PostScan on page 265 for detailed information about the PreScan and PostScan features.</p>
Encryption mode	<p>Decide whether or not to encrypt data in the partition and what type of encryption and encryption key management to use. The Encryption screen does not display unless you are logged into the library as an encryption user and have either created one or more BlueScale encryption keys or configured a Spectra SKLM or KMIP server. See the Spectra Tape Libraries Encryption User Guide for details.</p>

Component	Description
Robotic control path	<p>Decide on the exporting controller (an LTO drive or RIM2) for the library robotics.</p> <p>Notes:</p> <ul style="list-style-type: none"> ▪ If you plan to select both ports on the exporting controller, make sure that the software used with the partition supports using multiple control paths and that the ports are cabled correctly. Selecting both ports provides redundancy, but requires software that supports two control paths to the robotics. ▪ You can select multiple similar exporting controllers (RIM2s or drives), and export the same changer interface over them to provide redundancy, as long as your storage management software supports this. These multiple paths cannot be used at the same time. ▪ The maximum number of exporters supported by the library is six. <ul style="list-style-type: none"> ▪ Six drive exporters can be used for six different partitions, or multiple exporters can be configured in the same partition, reducing the maximum number of partitions. ▪ A single RIM2 can export up to 16 partitions, but still only count as one exporter.
Controller port addressing	<p>If the robotic control path is provided by a RIM2, decide what port addressing (soft addressing or Loop ID) and Fibre mode (Loop, Fabric, or Auto-negotiate) each port on the controller uses. If you select soft addressing, each Fibre Channel port is assigned a unique address when it connects to the Fibre Channel arbitrated loop, fabric, or SAN. If you do not use soft addressing, each port uses the fixed Loop ID you set.</p>
Direct-attached Fibre Channel drive addressing	<p>For each Fibre Channel drive, decide whether to use soft addressing or an assigned Loop ID. If you select soft addressing, each Fibre Channel port is identified by an address assigned to the drive when it connects to the Fibre Channel arbitrated loop, fabric, or SAN. If you do not use soft addressing, each port uses the fixed Loop ID you set.</p>

CREATING A CLEANING PARTITION

The following sections describe using the BlueScale partition wizard to create a cleaning partition for your library. If you know that you want to use Auto Drive Clean with a storage partition, it is easier to configure the cleaning partition before you configure the storage partition(s). If you choose to create the storage partitions before you create the cleaning partition, Auto Drive Clean is not enabled until you modify the storage partitions to assign a cleaning partition to them.

Note: If you want to configure the storage partitions first, skip to [Creating a Storage Partition on page 169](#).

Define the Initial Cleaning Partition Settings

1. Log in as a user with superuser or administrator privileges.
2. From the toolbar menu, select **Configuration**  **Partitions** to display the Shared Library Services screen.
 - If one or more partitions are already created, the existing partitions are listed in alphabetical order. Click **New** to display the Name and Media Type screen.

Note: If the **New** button is not displayed then all chambers in the library are allocated. You need to delete a partition or edit an existing partition to free up chambers, or make hardware upgrades that increase the storage capacity of the library before you can create another partition.



Figure 80 Click **New** on the Shared Library Services screen to begin creating the cleaning partition.

- If the library does not currently have any partitions configured, select **Manually create a partition**, then click **New** to display the Name and Media Type screen.

Important

Do not select the **Automatically create a partition** option. Doing so configures a storage partition using the majority of the licensed chambers. You then need to modify the storage partition to make chambers available for a cleaning partition.



Figure 81 Select **Manually create a partition**.

3. Enter a name for the partition and select **LTO Clean** or **TS11x0 Clean** as the media type.

Figure 82 Enter a name for the partition and select **LTO Clean** or **TS11x0 Clean** to create a cleaning partition.

For this field...	Do the following...
Name	Enter a unique, descriptive name to identify the partition as a cleaning partition. Names can be any length and can include @ - _ / . and the space character. Partition names over 32 characters causes a scroll bar to display on some screens and are not recommended. Note: The default name for a cleaning partition is “Cleaning <i>n</i> ”, where <i>n</i> is a number. The partition names are listed alphabetically on many of the BlueScale screens. If you want the cleaning partitions to be listed after the storage partitions, precede the name with a “z” or “_”.
Media Type	Select LTO Clean or TS11x0 Clean to create a cleaning partition.

Configure the Chambers for the Partition

1. From the Name and Media Type screen, click **Next**. The Chambers and Drives screen displays.

Figure 83 Specify the number of chambers for the cleaning partition.

2. Enter the number of chambers you want to assign to the cleaning partition.
3. Proceed to [Confirming and Saving the Partition Settings](#) on page 187.

CREATING A STORAGE PARTITION

The following sections describe using the BlueScale partition wizard to create a new storage partition.

Define the Initial Storage Partition Settings

If you did not yet create any partitions on the library, you can choose to either have the BlueScale partition wizard automatically create a single storage partition that uses all or most of the licensed chambers and installed drives or you can use the wizard to manually create storage partitions to your own specifications.



Important

The drives you plan to use in the partition must be installed in the library before you start configuring the partition.



Important

Components not configured in a partition may not display in the BlueScale interface for a few minutes after library initialization.

Automatically Create a Partition Use the following steps to have the BlueScale partition wizard automatically create a single storage partition. The partition uses all installed drives, has a single chamber assigned to the entry/exit pool, and has all or most of the remaining licensed chambers assigned to the storage pool. If the entire library is licensed, one chamber per frame is left out of the partition to optimize tape movements.

1. Log in as a user with superuser or administrator privileges.
2. From the toolbar menu, select **Configuration**  **Partitions** to display the Shared Library Services screen.
3. Select **Automatically create a partition** from the initial Shared Library Services screen (see [Figure 84](#) on page 170) and click **New**.

- Notes:**
- This option is only available if all of the drives in the library are of the same type (LTO or TS11xx technology) and there are currently no partitions, including cleaning partitions.
 - If you want to use Auto Drive Clean with the partition and the library does not contain unlicensed chambers, you need to modify the partition after it is created to remove some of the chambers assigned to it so that you can create a cleaning partition.

- If you want to use the Global Spare option with the partition, you need to modify the partition after it is created to unassign one or more of the drives that were automatically assigned to the partition, and then reassign those drives as Global Spares.
- If you want to use encryption with the partition, you need to modify the partition after it is created to enable encryption (see the *Spectra Tape Libraries Encryption User Guide*).

Manually Create a Partition Use the following steps to create a storage partition using the partition wizard.

1. Log in as a user with superuser or administrator privileges. If you want to configure encryption in the partition, you must also log in as an encryption user (see the *Spectra Tape Libraries Encryption User Guide* for more details).
2. From the toolbar menu, select **Configuration** ... **Partitions** to display the Shared Library Services screen.
 - If one or more partitions already exist, the existing partitions are listed in alphabetical order. Click **New** to display the Name and Media Type screen.

Note: If the **New** button is not displayed, then all chambers in the library are allocated or the maximum number of partitions already exist. You need to delete or edit an existing partition to free up chambers, license more chambers, or make hardware upgrades that increase the storage capacity of the library before you can create another partition.



Figure 84 Click **New** on the Shared Library Services screen to begin creating the storage partition.

- If the library does not currently have any partitions configured, select **Manually create a partition** and click **New** to display the Name and Media Type screen.



Figure 85 Select **Manually create a partition** on the Shared Library Services screen when there are no partitions.

3. Enter a name for the storage partition and select the media type.

Note: If the storage partition media type is grayed out, then all licensed chambers are assigned to partitions. Edit an existing partition to free up chambers or purchase a Capacity on Demand key to increase the number of available storage chambers.



Figure 86 Enter a name for the partition and select the media type.

For this field...	Do the following...
Name	<p>Enter a unique, descriptive name to identify the partition. Names can be any length and can include @ - _ / . and the space character. Partition names over 32 characters causes a scroll bar to display on some screens and are not recommended.</p> <p>The default name for a storage partition is “Partition <i>n</i>”, where <i>n</i> is a number.</p> <p>Note: In many of the BlueScale screens, the partitions are listed alphabetically. Keep this in mind when naming your partitions.</p>
Media Type	<p>Select LTO to create a storage partition that uses LTO drives and media. Select TS11x0 to create a storage partition that uses TS11xx technology drives and media.</p>

Select the Robotic Control Path

Controllers in the library are used to provide the robotic control path for the partition. The controller “exports” the partition to the hosts, receiving and processing the robotic motion commands sent from the host to move tapes. RIM2s and LTO tape drive can act as controllers.

- Notes:**
- A RIM is identified as an F-QIP in the Robotic Control Path screen and other screens that reference controllers. See [RIM2 Identifiers on page 57](#) for additional information about the RIM identifier.
 - Partitions with greater than 930 slots, or spanning more than one frame, should use a RIM2 for the robotic control path. Exceeding this number with a drive providing the robotic control path may cause an inventory operation to time out in your data storage software.
 - A TS11xx technology drive cannot provide the robotic control path. TS11xx technology partitions must use a RIM2.
 - You can select multiple similar exporting controllers (RIM2s or drives), and export the same changer interface over them to provide redundancy, as long as your storage management software can support this. You cannot use multiple paths at the same time.
 - If a partition uses multiple exporting controllers, the partition cannot use QuickScan.
 - The maximum number of exporters supported by the library is six.
 - Six drive exporters can be used for six different partitions, or multiple exporters can be configured in the same partition, reducing the maximum number of partitions.
 - A single RIM2 can export up to 16 partitions, but still only count as one exporter.

- The library does not support selecting drives and a RIM2 to export the partition.

Use the following instructions to select the robotic control path:

1. From the Name and Media Type screen, click **Next**. The Robotic Control Path screen displays a list of the controllers currently installed in the library.



Figure 87 Select the exporting controller.

2. Select the controller(s) to provide the control path for the robotics.



Important

If you want to use the controller failover feature for RIM2s (see [Configure Controller Failover on page 119](#)), keep the following requirements in mind:

- You must have at least two controllers (RIM2s) installed in the library.
- If you configured controller failover before you configured the storage partition, select the primary controller in the failover pair to provide the robotic control path.



Important

Do not select more than one drive to provide the robotic control path unless you know your storage management software can support this.



Important

If you select two different generations of drives to provide the robotic control path, then you are not able to assign a Global Spare to the partition because all drives in a partition with a Global Spare must match the technology generation of the Global Spare.

Assign Global Spare Drives

The Global Spare option lets you remotely substitute a working drive for a failed one using a spare drive in the library. Having a Global Spare drive in the library lets you continue your backup operations and replace the failed drive the next time you are physically present at the library. See [Using a Global Spare Drive on page 352](#) for instructions on how to use the Global Spare drive in place of a failed drive.

Requirements Before you can configure the Global Spare option, the following requirements must be met:

- The partition must use Fibre Channel LTO or TS11xx technology drives. The Global Spare feature is not available for use with other drive technologies.
- In addition to the drives assigned to the partition for use by the host software, the library must have Fibre Channel drives available for use as spares in the partition.
- All of the drives in a partition with a Global Spare must match the technology and generation of the Global Spare.
- The drives that are configured as Global Spares must be connected to the same Fibre Channel arbitrated loop or fabric as the drives they would replace. You may need to reconfigure your switch to access the Global Spare drive.

Partition Requirements When configuring the partition, keep the following in mind:

- The type of drive you select as the Global Spare determines the type of drives that you can assign to the partition.
- The library prevents you from selecting drives that cannot be used as Global Spares, including drives already selected as controllers.
- Although a Global Spare drive can be shared by multiple partitions, the drive can only be used by one partition at a time. To ensure that each partition has access to a Global Spare when needed, configure one or more dedicated Global Spare drives for each partition.
- If you do not currently have a drive that can be used as a Global Spare installed in the library, but install one later, you can edit the partition to configure Global Spares.

PostScan Requirements If you plan to use one of the MLM PostScan features that requires a Global Spare drive, you must configure at least one Global Spare drive for the partition.

Keep in mind that when the PostScan process starts, it “owns” the Global Spare drive it is using until all of the cartridges in the PostScan queue are processed (unless you pause the PostScan operation as described in [Pause the PostScan Process on page 272](#)). If a shared Global Spare drive is being used for PostScan it is not available for use as a spare. Configuring one or more dedicated Global Spare drives for each partition that uses PostScan is highly recommended.

Note: See [Using PostScan on page 265](#) for information about the PostScan feature.

Configuration Process Use the following steps to configure one or more Global Spare drives for the partition.

1. From the Robotic Control Path screen, click **Next**. The Spare Drives screen lists the drives that are available for use as Global Spares.

If you do not want to configure spare drives, click **Next** again and skip to [Allocate Chambers and Drives](#) on page 176.

2. Select one or more of the available drives to be designated as spares. Drives that cannot be used as spares are grayed out.

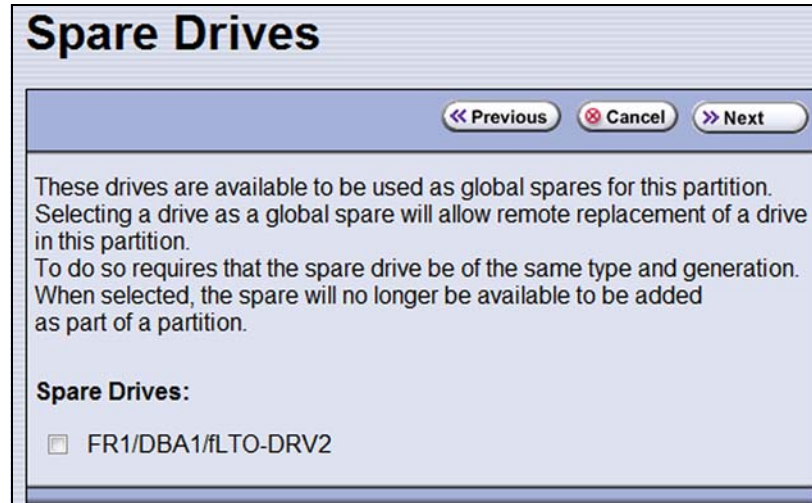

Figure 88 Select the drives you want to use as Global Spares.

Allocate Chambers and Drives

Use the following steps to allocate chambers and drives for the partition.

1. From the Spare Drives screen, click **Next**. The Chambers and Drives screen displays.

Chambers and Drives

<< Previous Cancel >> Next

Slots are allocated to partitions on a chamber basis. Partitions must allocate chambers for both storage and entry/exit. For the media type of this library there are 10 slots per chamber.

Storage Chambers:

EE Chambers:

A maximum of 84 chambers can be allocated to this partition.

Choose the drives this partition will use. NOTE: Removing/Adding drives may change the LUN mapping of the remaining devices exported via the QIP. You may need to reconfigure your host software. Mixing LTO SCSI and LTO3 Fibre drives in a single partition is not allowed

Drives: FR1/DBA4/FLTO-DRV1
 FR1/DBA4/FLTO-DRV3
 FR1/DBA4/FLTO-DRV4

Figure 89 The Chambers and Drives screen for a library without Thin Provisioning enabled.

Chambers and Drives

<< Previous Cancel >> Next

Slots are allocated to partitions on a chamber basis. Partitions must allocate chambers for both storage and entry/exit. For the media type of this library there are 9 slots per chamber.

Storage Chambers:

EE Chambers:

Thin Provisioning is enabled. The combined total of storage slots, entry/exit slots, and drives allowed for this partition is 20000.

Choose the drives this partition will use. NOTE: Removing/Adding drives may change the LUN mapping of the remaining devices exported via the QIP. You may need to reconfigure your host software. Mixing LTO SCSI and LTO3 Fibre drives in a single partition is not allowed

Drives: FR1/DBA6/FTS11x0-DRV3

Figure 90 The Chambers and Drives screen for a library with Thin Provisioning enabled.

2. Complete the following information in the Chambers and Drives screen.

For this field...	Do the following...
Storage Chambers	<p>Enter the number of storage chambers to assign to the storage pool for this partition. If Thin Provisioning is not enabled in the library, the screen displays how many chambers are available for the partition. If Thin Provisioning is enabled, the screen displays how many elements (storage slots + entry/exit slots + drives) are allowed.</p> <p>Notes:</p> <ul style="list-style-type: none"> ▪ Each chamber accommodates one TeraPack magazine. Each magazine has slots for either ten LTO cartridges or nine TS11xx technology cartridges. ▪ If Thin Provisioning is enabled it is possible for the combined configured number of storage slots in all partitions to exceed the licensed or physically available number of slots. ▪ If Thin Provisioning is not enabled: <ul style="list-style-type: none"> ▪ If you plan to create multiple partitions, be sure to reserve enough chambers to configure the other partitions. ▪ If you licensed all of the chambers in the library and want to use a cleaning partition, be sure to reserve enough chambers for the cleaning partition. If you did not license all of the chambers in the library, the unlicensed chambers are available for use in cleaning partitions.

For this field...	Do the following...
EE Chambers	<p>Enter the number of chambers to assign to the entry/exit pool for this partition.</p> <p>Notes:</p> <ul style="list-style-type: none"> ▪ Some storage management software features require an entry/exit pool. Spectra Logic recommends assigning at least one entry/exit chamber. ▪ It is useful for the entry/exit pool to be larger than the expected import/export operations you plan to do on a daily or weekly basis. ▪ The cartridges stored in the entry/exit pool are not accessible to the storage management software for writing or reading data.
Drives	<p>Select the drives to be dedicated to this partition. The check boxes for any installed drives that cannot be used in the partition are grayed out. Any drive already selected as a controller is automatically selected and cannot be cleared.</p> <p>Notes:</p> <ul style="list-style-type: none"> ▪ You cannot use Fibre Channel and SAS drives in the same partition. ▪ If you enabled Global Spares (see Assign Global Spare Drives on page 173), you can only select Fibre Channel drives of the same generation as the Global Spare drive assigned to the partition. ▪ If you plan to mix multiple generations of LTO cartridges in the same partition, make sure that the drives in the partition are compatible with every generation of data cartridge in the partition (see LTO Read/Write Compatibility on page 491 for compatibility information).
Cleaning Partition	<p>Select the name of the cleaning partition to be used for the drives in the storage partition. Associating a cleaning partition with the storage partition enables the Auto Drive Clean feature for the partition. If you do not want to enable Auto Drive Clean, select None.</p> <p>Note: The option to select a cleaning partition is only available if you previously configured a cleaning partition that uses the same type of media as the storage partition (see Creating a Cleaning Partition on page 166). If you create a cleaning partition later, edit the storage partition to associate the cleaning partition with it.</p>

Enable and Configure MLM PreScan and PostScan

When MLM is enabled, you can configure the partition to use the MLM PreScan and PostScan features. See [Using PreScan on page 264](#) and [Using PostScan on page 265](#) for information about these features.

- Notes:**
- MLM is enabled by default. If you want to use PreScan and PostScan but do not see the MLM Media Verification screen, check to see if MLM is disabled (see [Enabling MLM and Configuring Global Settings on page 253](#)).
 - If the partition uses SAS drives, the partition cannot use FullScan or QuickScan with Global Spares.
 - If a partition uses multiple exporting controllers, the partition cannot use QuickScan.
 - If you enable PostScan, the options for SKLM or KMIP Encryption are not available when you get to the Encryption screen.

Use the following steps to configure the PreScan and PostScan features used in the partition.

1. From the Chambers and Drives screen, click **Next**. The MLM Media Verification screen displays.

Note: If you do not want to use the PreScan and PostScan features, click **Next** again and skip to [Select the Encryption Mode on page 181](#).

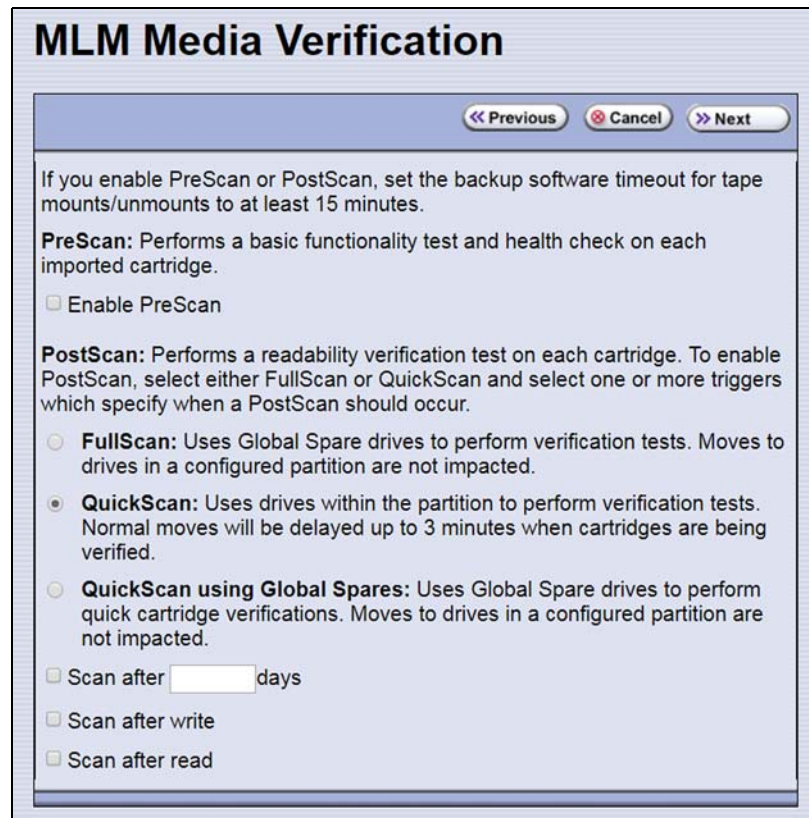

Figure 91 The Media Verification screen.

2. Enable and configure the PreScan and PostScan options for the partition.

Notes:

- Selecting any of the PostScan triggers automatically enables the selected PostScan option for the partition.
- If you enable PostScan, the options for SKLM or KMIP Encryption are not available when you get to the Encryption screen.
- The automatic PostScan operation configured on this screen only verifies MLM-enabled cartridges. If your partition uses cartridges that are not MLM-enabled, you must add them to the PostScan queue manually (see [Request a Manual PostScan on page 270](#)).

The following table describes the PreScan and PostScan options.

Option	When selected...	Default
Enable PreScan	Enables the PreScan feature. When enabled, PreScan replaces the more basic Media Auto Discovery process. See Using PreScan on page 264 for information about this option.	Disabled (cleared)
FullScan	Enables the FullScan feature. When enabled by selecting one or more PostScan triggers, FullScan uses a Global Spare drive assigned to the partition to verify all of the data on each cartridge. See Using PostScan on page 265 for information about this option. Note: FullScan is only available if a Global Spare drive is configured for the partition.	Disabled (no PostScan triggers selected)
QuickScan	Enables the QuickScan feature. When enabled by selecting one or more PostScan triggers, QuickScan uses one of the drives in the partition to verify the data on a single wrap, from the beginning of the tape (BOT) to the end of the wrap or the end of recorded data (EOD), whichever comes first. See Using PostScan on page 265 for information about this option.	Disabled (no PostScan triggers selected)
QuickScan using Global Spares	Enables the QuickScan using Global Spares feature. When enabled by selecting one or more PostScan triggers, QuickScan uses a Global Spare drive assigned to the partition to verify the data on a single wrap, from the beginning of the tape (BOT) to the end of the wrap or the end of recorded data (EOD), whichever comes first. See Using PostScan on page 265 for information about this option. Notes: <ul style="list-style-type: none"> ▪ QuickScan using Global Spares is only available if a Global Spare drive is configured for the partition. ▪ QuickScan using Global Spares is only available if the partition uses Fibre Channel drives. 	Disabled (no PostScan triggers selected)
PostScan Triggers	Enables PostScan and configures one or more triggers. <ul style="list-style-type: none"> ▪ Verify After Time — Add the cartridges in the partition to the automatic PostScan queue after the specified number of days pass since the last scan. Enter the number of days in the Days field. ▪ Verify After Write — Add a cartridge to the automatic PostScan queue each time data is written to it. ▪ Verify After Read — Add a cartridge to the automatic PostScan queue each time data is read from it. Note: Selecting any of these triggers automatically enables the selected PostScan option.	Disabled (cleared)

Select the Encryption Mode

If you are creating a partition or editing a partition that does not currently use encryption, the Encryption screen only displays if you are logged into the library as an encryption user and have either created one or more BlueScale encryption keys, or configured a Spectra SKLM or KMIP server. If you are not logged into the library as an encryption user and you are editing a partition with encryption, the Encryption screen displays with all options grayed out.

Note: If you are not logged into the encryption feature, or did not create a BlueScale encryption key, or configure a Spectra SKLM or KMIP server, proceed to [Configure the Drive Fibre Channel Addressing on page 183](#). You can modify the partition to use encryption later, as described in this section.

Requirements You must log into the library as an encryption user, and have BlueScale encryption keys already created, or a Spectra SKLM or KMIP server already configured to be able to configure encryption for a partition.

- Notes:**
- See the *Spectra Tape Libraries Encryption User Guide* for detailed instructions about configuring and using encryption in the library.
 - Any options that are not supported for the partition you are currently configuring are grayed out.
 - You can only use one type of encryption in a partition.
 - You can only configure KMIP encryption servers or Spectra SKLM encryption servers, not both.
 - KMIP encryption and Spectra SKLM encryption are not compatible with PostScan. Do not enable PostScan for the partition if you want to use KMIP encryption or Spectra SKLM encryption.
 - Spectra SKLM key management, KMIP encryption, and BlueScale encryption are not compatible with each other. Data encrypted using one type of encryption key management cannot be decrypted using another.
 - BlueScale Encryption is not supported for partitions with TS11xx technology drives.

Use the following steps to configure encryption in the partition:

1. From the Chambers and Drives screen, click **Next**. The Encryption screen displays.

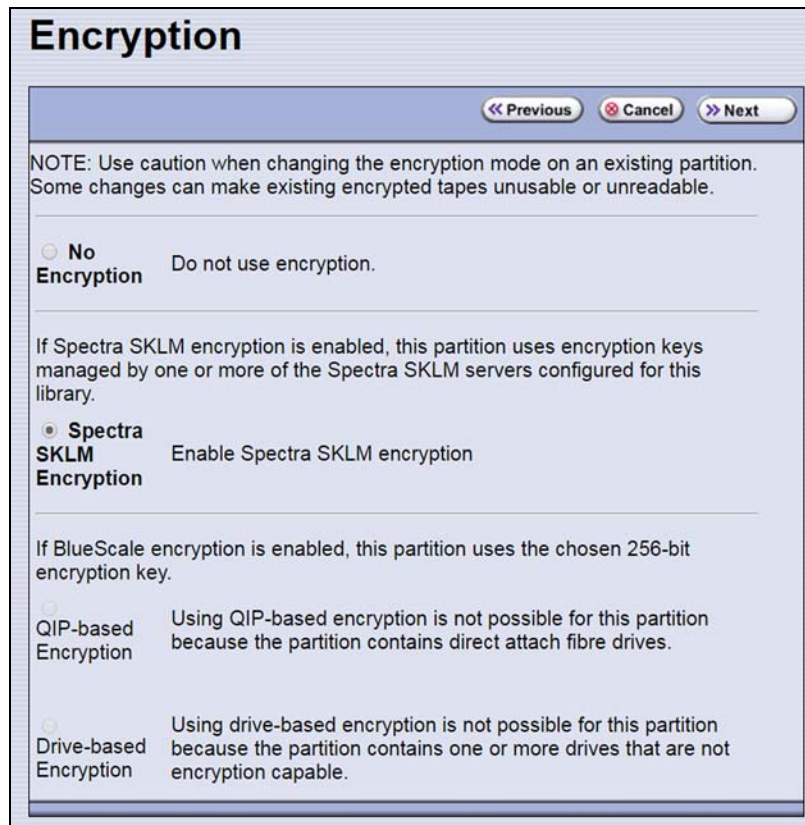

Figure 92 The Encryption screen.

2. Select the type of encryption you want to enable. See the *Spectra Tape Libraries Encryption User Guide* for detailed instructions.

Encryption Option	Description
No Encryption	Turns off encryption. None of the data in the partition is encrypted.
Spectra SKLM Encryption	Turns on Spectra SKLM Encryption key management for drive-based encryption using LTO or TS11xx technology drives. Note: If PostScan is enabled for the partition, do not select Spectra SKLM Encryption.
KMIP Encryption-Reuse (not shown)	Turns on KMIP encryption key management for drive-based encryption using LTO or TS11xx technology drives. The library reuses KMIP encryption keys when tapes are overwritten. Note: If PostScan is enabled for the partition, do not select KMIP Encryption.
KMIP Encryption - No Reuse (not shown)	Turns on KMIP encryption key management for drive-based encryption using LTO-6 and later generation drives or TS11xx technology drives. The library does not reuse KMIP encryption keys when tapes are overwritten. Note: If PostScan is enabled for the partition, do not select KMIP Encryption.

Encryption Option	Description
BlueScale Encryption: QIP-based	Not supported for this library.
BlueScale Encryption: Drive-based	<p>Turns on BlueScale Encryption key management for drive-based encryption using LTO drives. All key management tasks are performed through the BlueScale user interface.</p> <p>Note: If you have BlueScale Encryption Professional edition and multiple encryption keys configured on the library, select the primary key for the partition. This key is used when encrypting and decrypting data. Then, select none, one, or up to eight keys to be associated with the partition for decrypting data.</p>

Configure the Drive Fibre Channel Addressing

For partitions containing Fibre Channel drives, the Fibre Channel Loop ID screen configures the Fibre Channel addressing used by each drive in the partition. In general, you want to select the same type of addressing for every drive in a partition.

1. From the Encryption screen (or the MLM Media Verification screen), click **Next**. The Fibre Channel Loop ID's screen displays.

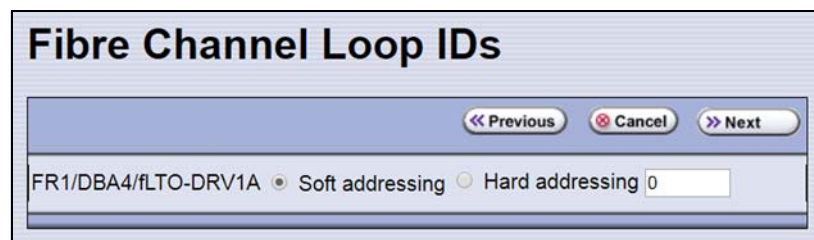

Figure 93 Select the type of addressing to be used by the Fibre Channel drives.

2. Select **Soft Addressing** or **Hard Addressing** for each of the drives listed.
 - The drives use soft addressing by default. A drive is assigned a soft address when it connects to the Fibre Channel arbitrated loop or fabric.
 - If you select **Hard Addressing**, enter a value between 0 and 125 in the text field. This value is the Loop ID used by the drive when it connects to the Fibre Channel arbitrated loop or fabric. The ID you enter must be unique for every device in the loop or fabric.

- Notes:**
- Spectra Logic recommends using soft addressing where possible for Fibre Channel drives.
 - SAS tape drives do not have Loop IDs.

Specify the Partition Users

1. From the Fibre Channel Loop ID's screen, click **Next**. The Partition Users screen displays.

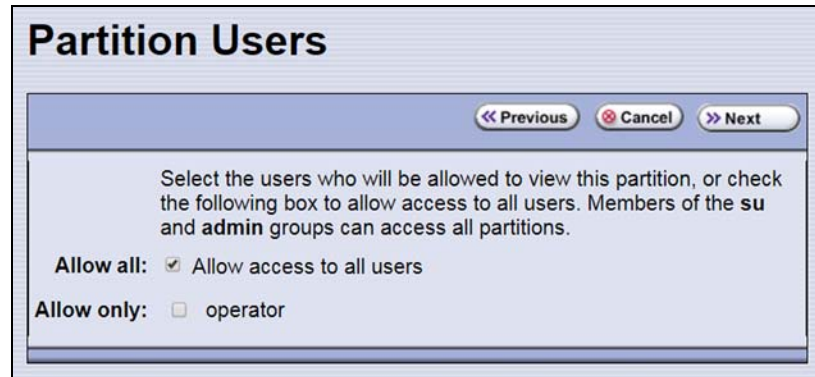

Figure 94 Select which users can access the partition.

2. Select the users who are allowed access to this partition. Only users who were previously configured can be selected (see [Configuring Library Users on page 90](#)).
 - Notes:**
 - All of the users who are configured with operator privileges are listed under **Allow only**. Select one or more of these users to enable partition-based security for operators.
 - If you did not configure additional Operator level users, you can do so later and then edit the partition to give them access.
 - Superusers and administrators always have full access to all partitions.



Important

If you are using a tape drive to provide the robotic control path, this is the last partition configuration screen. Skip to [Confirming and Saving the Partition Settings on page 187](#).

Configure the Robotic Path Visibility

Robotic path visibility determines whether one or both of the Fibre Channel ports on the exporting controller provide the robotic control path.

Use the following steps to configure the robotic path visibility.

1. From the Partition Users screen, click **Next**. The Robotic Path Visibility screen displays.

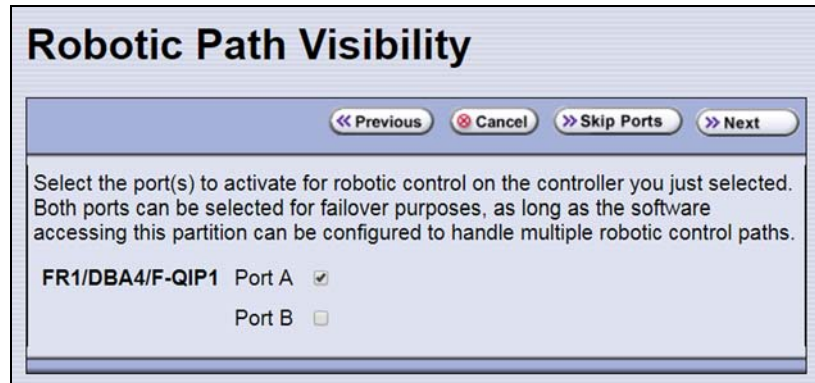

Figure 95 Select the port on the exporting controller that is used to communicate with the robotics.

2. Select either one or both ports to provide the robotic control path.

- Notes:**
- Selecting both ports provides a redundant connection to the robotics, but requires software that supports two control paths.
 - Alternatively, you can use two controllers and configure controller failover (see [Configure Controller Failover on page 119](#)).
 - The WWPN of the Fibre Channel port on the exporting controller is used as the WWN for the partition. See [World Wide Names for Fibre Channel Partitions on page 62](#) for detailed information about the relationship between the Fibre Channel port on the exporting controller and WWNs for partitions.

Configure the Port Addressing for the Controllers

For each RIM2 in the partition, identify the port(s) through which the hosts communicate with the components (the robotics or drives) connected to the controller.

If you previously configured the settings for both the exporting controller and do not want to make any changes, click **Next** on the Exporting F-QIP Configuration screen to proceed to [Confirming and Saving the Partition Settings on page 187](#).

Use the following steps to configure the port addressing for the exporting controller.

1. From the Robotic Path Visibility, click **Next**. The Exporting F-QIP Configuration screen displays.

Note: A RIM2 can export up to 16 partitions. If a RIM2 exports multiple partitions, a confirmation screen warns you that any changes you make apply to all partitions associated with the exporting controller.

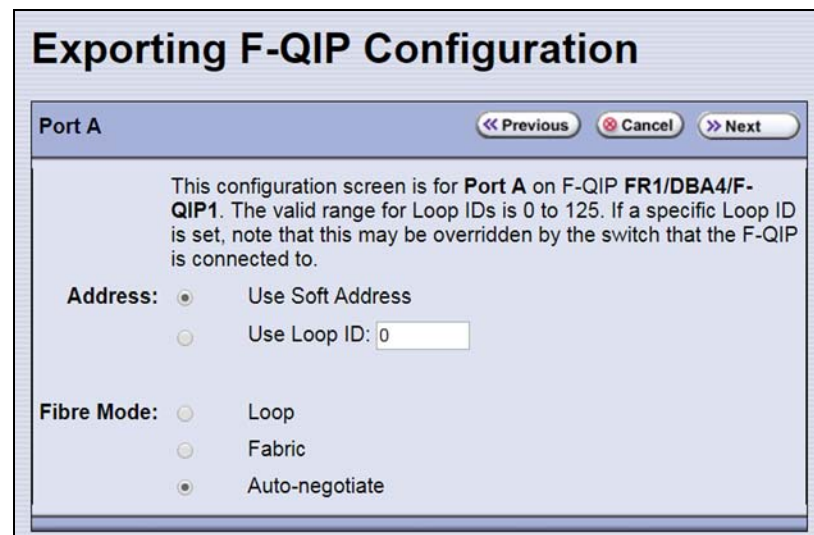

Figure 96 The Exporting F-QIP Configuration screen for robotics.

2. Select one of the following combinations for the **Address** and **Fibre Mode**:
 - **Use Soft Address** and **Fabric**.
 - **Use Soft Address** and **Auto-negotiate**.
 - **Use Loop ID** and **Loop**. The Loop ID must be between 0 and 125.
 - **Use Loop ID** and **Auto-negotiate**. The Loop ID must be between 0 and 125.

Note: If you select **Loop** as the Fibre Mode, the Fibre Channel switch to which the RIM is connected may override your settings.

3. If you selected both ports on the Robotics Visibility screen ([Configure the Robotic Path Visibility on page 184](#)), repeat the configuration steps in this section for the other Fibre Channel port.

If you have multiple exporters, repeat the configuration steps in this section for the port(s) on the additional exporters.

If you only selected one port in the Robotic Path Visibility screen or if you have already configured both ports, proceed to [Confirming and Saving the Partition Settings](#).

CONFIRMING AND SAVING THE PARTITION SETTINGS

After you finish configuring a partition, confirm and save the partition settings to complete the creation process.

Note: If you want to save the configuration to a USB device, connect the device to a USB port on the LCM or operator panel (see [Connect a USB Device to the Library on page 158](#)) and allow time for the device to mount before continuing.

1. After you complete the configuration screens for the partition as described in the previous sections, click **Next**. The Save Library Configuration screen displays.

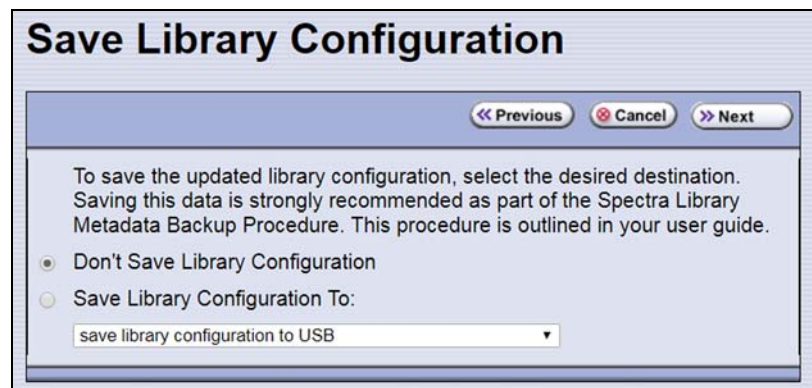

Figure 97 The Save Library Configuration screen.

2. Select whether you want to save the current library configuration.
 - **Don't Save Library Configuration** — A backup of the changed library configuration is not saved.
 - **Save Library Configuration To** (highly recommended) — Saves a backup of the library configuration to the selected destination. Using this option is highly recommended to ensure that you can easily restore the previous library configuration, if necessary.

Select whether to save the library configuration file to a USB device or to email it to an already-configured mail recipient (see [Configure Mail Users on page 106](#)).

Note: Do not use the default *autosupport@spectralogic.com* email recipient. Spectra Logic does not save emailed configuration files unless they are specifically requested for troubleshooting.

3. Click **Next**. The Save Partition screen displays.

Note: The Save Partition screen on your library may be different from the ones shown in [Figure 99](#) and [Figure 98](#). The information on this screen varies depending on the type of partition you configured and the options you chose.



Figure 98 The Save Partition screen for a cleaning partition.

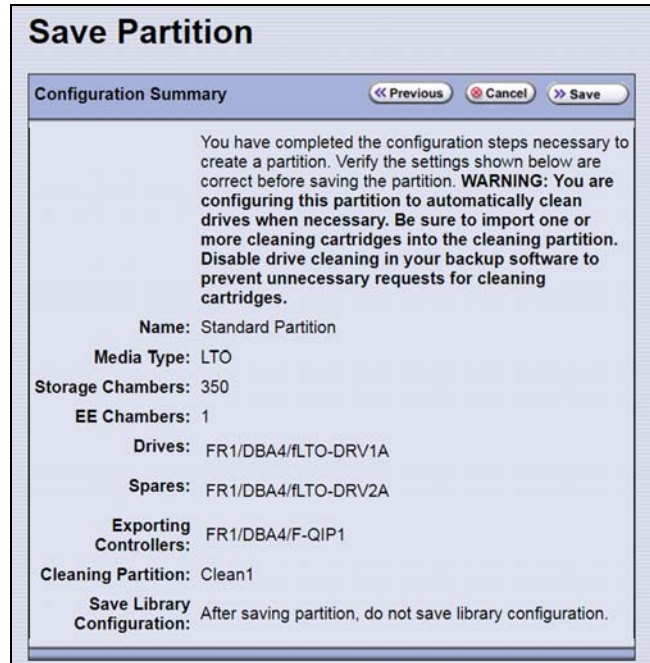

Figure 99 The Save Partition screen for a storage partition that uses a Global Spare and a cleaning partition.

4. Review the information on the screen and confirm that all settings are correct for this partition's configuration.
- If the configuration information is correct, proceed to [Step 5](#).
 - If the configuration information is not correct, do one of the following:
 - Click **Previous** to move backward through the configuration screens until you reach the settings that need correcting. As you move backward through the configuration screens, the values reset to their default values. After you reach the desired screen and make the necessary changes, click **Next** to advance through the screens and re-enter the necessary information until you return to the Save Partition screen.
- Note:** If the screen requiring the correction is toward the beginning of the configuration process, it may be easiest to click **Cancel** and repeat the entire configuration process.
- Click **Cancel** to configure the partition again from the beginning.

5. Click **Save**. The library requires several minutes to create the partition, after which the Shared Library Services screen redisplay with the partition you just created added to the list of partitions.

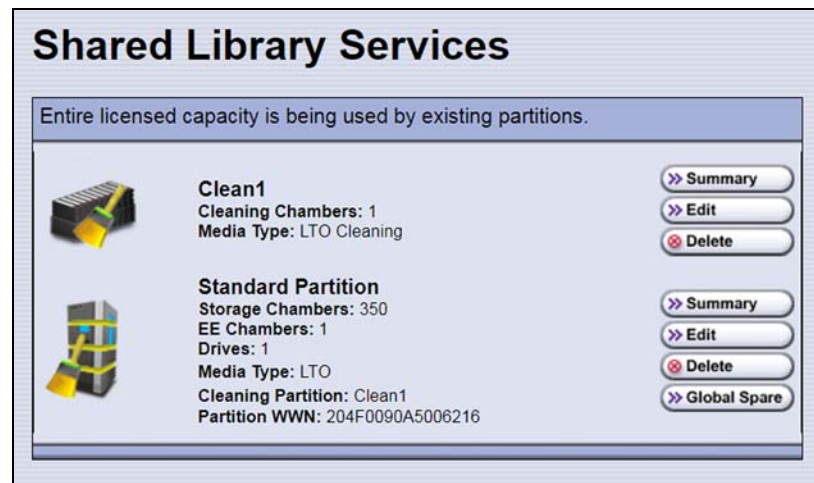

Figure 100 The Shared Library Services showing a cleaning partition and storage partition.

- Notes:**
- If you assigned a cleaning partition to the storage partition, the partition icon changes as shown in [Figure 100](#).
 - When you save the partition, the library automatically generates a configuration backup file and saves it to the memory card in the LCM. This backup file contains the library configuration, the MLM and DLM databases, and any BlueScale encryption keys that are currently stored in the library.
 - If you configured the email option for the automatically generated backup file, the library sends an email with the backup file attached to the specified recipient (see [Enable Email for the Auto Configuration Save File on page 108](#)).
6. To configure another storage partition, repeat the entire configuration process, beginning with [Creating a Storage Partition on page 169](#).
To configure another cleaning partition, repeat the entire configuration process, beginning with [Creating a Cleaning Partition on page 166](#).

MODIFYING AN EXISTING PARTITION

Overview This section describes how to edit or modify an existing partition.



Caution

Use your storage management software to empty all drives and discontinue host operations before modifying an existing partition.

- Notes:**
- You cannot modify a partition to change the exporter from a RIM2 to a drive.
 - You cannot change the media type (and thus the drive type) specified for the partition.

You might want to modify an existing partition for any of the following reasons:

- **Assign a Cleaning Partition** — If you created a cleaning partition and now want to assign it to the storage partition, you need to modify the Chambers and Drives screen for the storage partition to add the cleaning partition.
- **Assign a Global Spare Drive** — If you want to designate one of the unassigned drives as a Global Spare, you need to modify the Spare Drives screen to assign the drive to the partition.
- **Make Resources Available to Create a New Cleaning or Storage Partition** — If the existing partitions use all of the licensed chambers in the library, and you want to create a new partition, you need to reduce the number of chambers assigned to an existing partition to provide the chambers needed for the new partition. If you want to create a storage partition, you may also need to install additional drives or unassign drives that were previously assigned to other partitions.
- **Rename Partition** — If you want to rename the partition, you need to modify it in the Name and Media Type screen.
- **Disable PreScan or Change the PostScan Settings** — If you want to change the settings that you chose (to take advantage of a new Global Spare drive, for example), you need to select a different setting in the MLM Media Verification screen.
- **Enable or Disable Encryption** — If you need to modify encryption settings for the partition, you need to log in as an encryption user and make the necessary changes.
- **Adding Additional Exporting Controllers** — If a partition is configured with one exporting controller, and you want to add additional controllers to export the library, you need to edit the partition and select the additional controllers.

Preparation Before making changes to an existing partition, review the information at the beginning of this chapter to ensure that you address any requirements (see [Partition Types and Requirements on page 160](#)). In addition, address the following recommendations and requirements:

- Spectra Logic strongly recommends backing up the library configuration, either to a USB device or as an attachment to an email sent to a previously configured mail recipient, before you make changes.
- When reducing the number of chambers assigned to a partition, physically export any magazines in those chambers, as described in [Exporting or Exchanging Magazines and Cartridges on page 209](#), before you remove chambers from the partition.



Important

By default, the library deletes empty chambers from a partition first. However, if all chambers are full, the library is forced to delete populated chambers. When this happens, the magazines in the deleted chambers are no longer accessible through the BlueScale interface or storage management software. You must add these chambers to either a new or an existing partition before the magazines are accessible again.

Auto Configuration Save When you make a change to a partition, the library generates an auto-configuration file and saves it to the memory card in the LCM. If you configured the email option for the Auto Configuration Save file, an email containing the updated library configuration, the MLM and DLM databases, and any BlueScale encryption keys stored in the library, are sent to the specified recipient (see [Enable Email for the Auto Configuration Save File on page 108](#)).

Note: Do not use the default *autosupport@spectralogic.com* email recipient. Spectra Logic does not save emailed configuration files unless they are specifically requested for troubleshooting.

Modify a Partition Use the following steps to modify an existing partition.

1. Log into the library as a user with superuser or administrator privileges.
2. Select **Maintenance**  **Media Lifecycle Management** to display the Media Lifecycle Management Tools screen. If Media Auto Discovery, PreScan, or PostScan is running (as indicated by the presence of a **Stop Discovery** or **Pause PostScan** button, respectively), do the following:
 - Click **Stop Discovery** to temporarily stop Media Auto Discovery or PreScan (see [Figure 138 on page 264](#)).
 - Click **Pause PostScan** to pause the PostScan for one hour (see [Figure 141 on page 273](#)).

3. If you configured the partition to use encryption or if you want to enable encryption in a partition that did not previously use it, select **Security**  **Encryption** to log into the encryption feature. The Encryption User Login screen displays.



Figure 101 Log into the Encryption feature if you need to change the encryption setting for the partition.

- a. Type the encryption user password, if one is set. Otherwise, leave the password blank.
- b. Click **OK** to display the Encryption Configuration screen.

After you log into the encryption feature, you can modify the encryption settings for the partition (see [Select the Encryption Mode on page 181](#)). You can also configure encryption settings and manage BlueScale encryption keys. See the *Spectra Tape Libraries Encryption User Guide* for detailed information about enabling and configuring encryption for a partition.

4. From the toolbar menu, select **Configuration**  **Partitions** to begin the partition configuration process. The Shared Library Services screen displays.



Figure 102 The Shared Library Services screen.

5. Click either **Summary** or **Edit**. Either option can be used when modifying a partition.
 - If you click **Summary** next to the partition that you want to edit, the Partition Settings screen displays, showing summary information related to the selected partition.

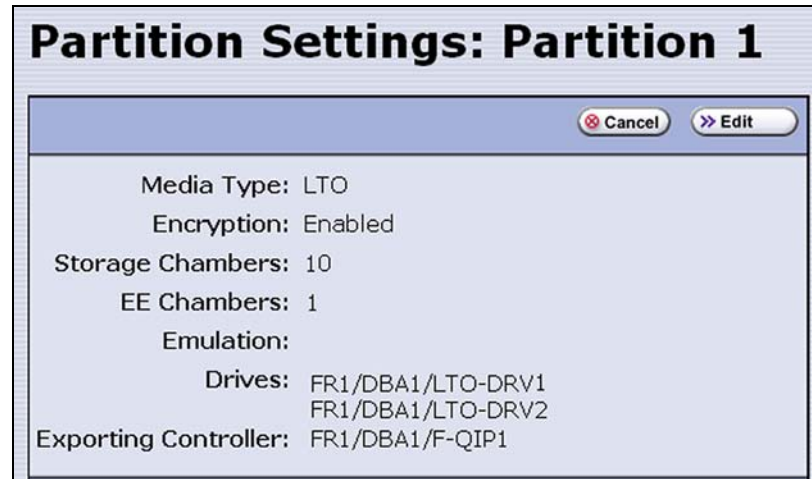

Figure 103 The Partition Settings screen (storage partition).

If you want to make changes or see all of the configuration settings for the partition, click **Edit**.

- If you click **Edit** from either the Partition Settings screen or the Shared Library Services screen the Name and Media Type screen displays.



Figure 104 The Name and Media Type screen for a cleaning partition.

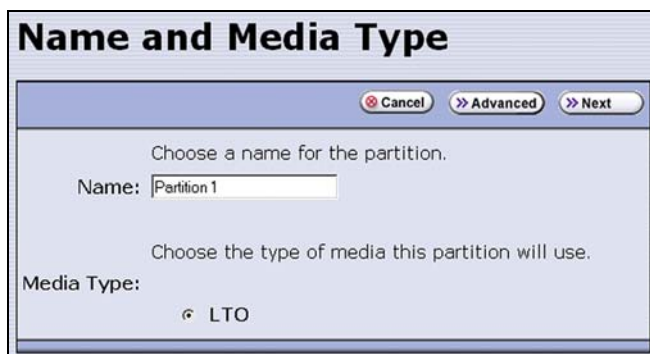

Figure 105 The Name and Media Type screen for a storage partition.

6. The Name and Media Type screen is the beginning of a series of configuration screens. Depending on the type of partition you are modifying, choose one of the following.
 - To modify a cleaning partition, see [Creating a Cleaning Partition on page 166](#),
— OR —
 - To modify a storage partition, see [Creating a Storage Partition on page 169](#).

DELETING A PARTITION

Overview When you delete a partition, the drives and chambers previously assigned to that partition are available to be assigned to a new or existing partition.

Preparation Before deleting an existing partition, review the information at the beginning of this chapter to be sure that you address any requirements (see [Partition Types and Requirements on page 160](#)). In addition, make sure you address the following:

- Spectra Logic strongly recommends backing up the library configuration, either to a USB device or as an attachment to an email sent to a previously configured mail recipient, before you delete a partition.
- To ensure that you do not inadvertently mix cartridges from one storage partition with that from another, use your storage management software to eject all of the cartridges from the storage partition's storage pool. The library moves the media to the partition's entry/exit pool. Export the media from the library as described in [Exporting or Exchanging Magazines and Cartridges on page 209](#).



Important

After the partition is deleted, any magazines in the chambers that were assigned to the partition's storage and entry/exit pools are not accessible until the chambers are assigned to another new or existing partition.



- If the storage partition is configured to use BlueScale encryption, make sure that you export the BlueScale encryption key for any cartridges that were in the partition (see the [Spectra Tape Libraries Encryption User Guide](#)). The encryption key is required in order to access the data on the cartridges at a later date.
- If you plan to delete a cleaning partition, edit any storage partitions that use the cleaning partition to unassociate the cleaning partition from the storage partition, otherwise, the delete fails.

Auto Configuration Save When you delete a partition, the library automatically generates a configuration backup file and saves it to the memory card in the LCM. If you configured the email option for the Auto Configuration Save file, an email with the backup file as an attachment is sent to the specified recipient (see [Enable Email for the Auto Configuration Save File on page 108](#)).

Note: Do not use the default *autosupport@spectralogic.com* email recipient. Spectra Logic does not save emailed configuration files unless they are specifically requested for troubleshooting.

Delete a Partition

Use the following steps to delete an existing partition.

1. Log in as a user with superuser or administrator privileges.
 2. Select **Maintenance**  **Media Lifecycle Management** to display the Media Lifecycle Management Tools screen. If Media Auto Discovery, PreScan, or PostScan is running (as indicated by the presence of a **Stop Discovery** or **Pause PostScan** button, respectively), do the following:
 - Click **Stop Discovery** to temporarily stop Media Auto Discovery or PreScan (see [Figure 138 on page 264](#)).
 - Click **Pause PostScan** to pause the PostScan for one hour (see [Figure 141 on page 273](#)).
 3. From the toolbar menu, select **Configuration**  **Partitions**. The Shared Library Services screen displays.
 4. Click **Delete** for the partition you want to delete. A Feedback Required screen displays.
 5. Select whether you want to save the current library configuration.
 - **Don't Save Library Configuration** — A backup of the changed library configuration is not saved.
 - **Save Library Configuration To** (highly recommended) — Saves a backup file of the changed library configuration to either a USB device connected to the library or as an attachment to an email sent to a previously configured recipient (see [Configure Mail Users on page 106](#)). Using this option is highly recommended to ensure that you can easily restore the library configuration if necessary.
- Note:** If you want to save the configuration to a USB device, connect it to a USB port on the LCM or the operator panel and allow time for the device to mount before continuing.
6. Click **Ok** to confirm that you want to delete the partition.

The screen refreshes and the deleted partition is no longer listed on the Shared Library Services screen.

CHAPTER 7

Importing and Exporting Cartridges

This chapter describes importing cartridges into and exporting cartridges out of the library.

- See [Chapter 8 – Using the Cartridge Inventory](#), beginning on [page 223](#) for information about moving cartridges from one location to another in a partition.
- See [Chapter 9 – Configuring and Using Media Lifecycle Management](#), beginning on [page 243](#) for information about using MLM to manage the cartridges in the library.

Topic	
Preparing Cartridges for Use	page 197
Cartridge Guidelines and Requirements	page 197
Prepare the Cartridges for Use	page 199
M8 Media	page 200
Import and Export Overview	page 201
Requirements	page 201
Restrictions	page 201
Importing into a Storage or Cleaning Partition	page 202
Import Requirements	page 202
Prepare the Storage Partition or the Cleaning Partition	page 205
Import the Magazines	page 206
Prepare the Entry/Exit Pool	page 209
Exporting or Exchanging Magazines and Cartridges	page 209
Prepare for the Export or Exchange	page 210
Export Magazines from a Partition	page 211
Exchange Magazines or Cartridges in a Partition	page 212
Export or Exchange Expired Cleaning Cartridges	page 213
Using the Advanced Import/Export Options	page 216
Manually Create a Move Queue	page 216

Topic	
Upload a Move Queue	page 219
Start the Moves	page 222
Updating the Storage Management Software Inventory	page 222

PREPARING CARTRIDGES FOR USE

Before you can load cartridges into the library, you must prepare and load them into TeraPack or Maintenance TeraPack magazines (referred to as magazines and maintenance magazines, respectively).

Cartridge Guidelines and Requirements

When preparing cartridges for use, keep the following guidelines and requirements in mind:

Spectra Certified Media For best performance, use Spectra Certified Media (both data and cleaning cartridges), which guarantees both media compatibility and the cartridge itself over its lifetime. Using Spectra Certified Media also lets you take full advantage of the library's Media Lifecycle Management (MLM) features. See [Chapter 9 – Configuring and Using Media Lifecycle Management](#), beginning on [page 243](#) for detailed information about using MLM to monitor the health of data and cleaning cartridges.

Multiple Tape Technology Generations When using multiple tape technology generations, Spectra Logic strongly recommends configuring separate partitions for each generation.

TeraPack Magazines Data cartridges are stored in TeraPack magazines while they are inside the library. Each TeraPack magazine holds either ten LTO cartridges or nine TS11xx technology cartridges. Similarly, the cleaning cartridges used in a cleaning partition are stored in Maintenance TeraPack magazines. Each maintenance magazine holds the same number of cartridges as a data cartridge magazine.

Barcode Labels To ensure that the library can properly maintain its media inventory, make sure that all cartridges and magazines have unique barcode labels. For your convenience, all Spectra Certified Media is available pre-labeled with sequential barcode labels. Optional custom barcode sequences can be ordered, if desired.

- **Data Cartridges** — The library prevents you from importing tape cartridges with blank/unreadable barcodes, with duplicate barcodes, or whose labels indicate that the media type or generation is not supported by the partition.
- **TeraPack Magazines** — Barcode labels are required on all magazines. Maintenance TeraPack magazines are identified by Spectra-unique labels. For your convenience, the pre-loaded magazines are labeled with sequential barcode labels. Optional custom barcode sequences can be ordered, if desired.
- **Cleaning Cartridges and Maintenance TeraPack Magazines** — If you plan to use a cleaning partition and the Auto Drive Clean feature, the cleaning cartridges must be identified with “CLN” at the beginning of the barcode sequence on their labels. This requirement applies to both standard and custom barcode labels. The cleaning cartridges must be stored in Maintenance TeraPack magazines, which are identified by Spectra-unique labels.

If you plan to store cleaning cartridges in a storage partition, labeling the cleaning cartridges with “CLN” at the beginning of the barcode sequence on their labels is highly recommended to help prevent the storage management software from attempting to use a cleaning cartridge for writing or reading data.

Write Protection Before loading data cartridges into the library, make sure that the write-protection switch is properly set. For normal backup operations, the write protect switch is set to the write-enabled or unlocked position. The write-protect switch is typically set to the write-protect or locked position when the cartridge is removed from the library for storage and during restore operations.

Prepare the Cartridges for Use

Use the following steps to prepare the individual cartridges to be loaded into the library.

1. If your cartridges are unlabeled, prepare and affix a barcode label to each cartridge. Position each label in the indented area on the cartridge, as illustrated in [Figure 106](#). See [Barcode Label Specifications](#) on page 492 for detailed information about barcode labels.



Caution

Do not place labels on any surface of the cartridge except the area shown in [Figure 106](#). An improperly positioned label can become dislodged and damage the drive.



Important

Before importing cartridges into the library, allow them to acclimate to the ambient environment for 24 hours.



Important

If you are using Auto Drive Clean, all cleaning cartridges must be identified with "CLN" at the beginning of the barcode sequence on their labels. This requirement applies to both standard and custom barcode labels.

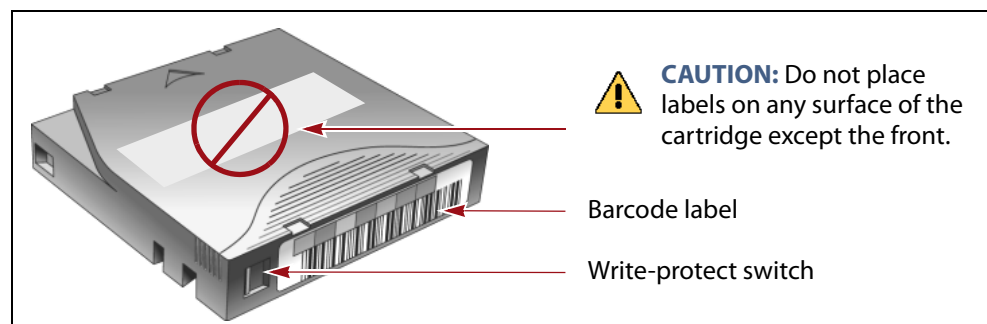

Figure 106 Attach barcode labels to cartridges and check write-protect switch setting (LTO cartridge shown.).

2. Depending on whether you plan to write data to a cartridge or restore data from a cartridge, make sure the write-protect switch on the cartridge is set for the desired operation.

Note: Cleaning cartridges do not have a write-protect switch.

If the switch...	The cartridge is...
Does not cover the opening	Write-enabled. Data can be written to or read from the tape.
Does cover the opening	Write-protected. Data can be read from the tape. Data cannot be written to or erased from the tape.

3. Insert the prepared cartridges into the magazine. Make sure that the cartridges are oriented with the hub side toward the front of the magazine, which has a textured surface on each side.

Important

Do not put data cartridges in a Maintenance TeraPack magazine. The Maintenance TeraPack magazine, with properly labeled cleaning cartridges, can only be used in a cleaning partition.

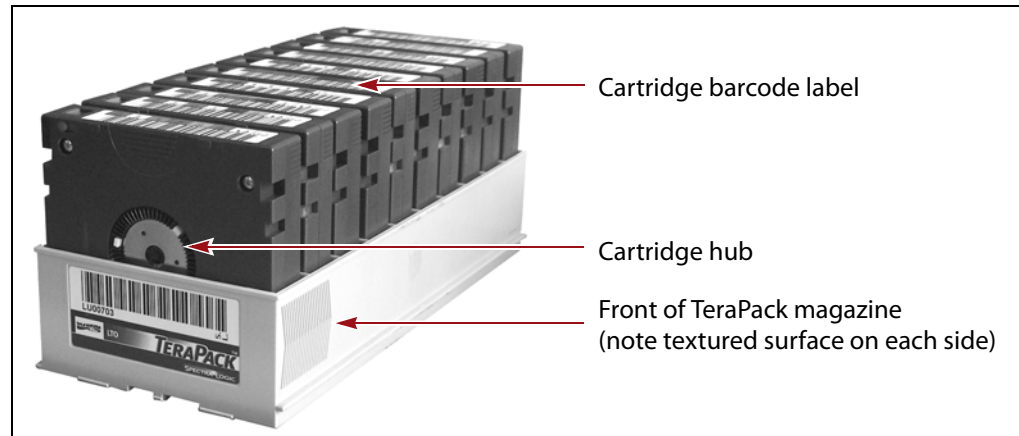

Figure 107 Insert prepared cartridges into a TeraPack magazine (LTO shown).

M8 Media

When the library loads an unused LTO-7 tape cartridge with a barcode label ending with “M8” into an LTO-8 tape drive using firmware HB82 or later, the drive attempts to initialize the tape for M8 density, increasing the density from 6 TB to 9 TB. Once initialized, the tape can no longer be written to, or read by, an LTO-7 drive.

To use the M8 feature, make sure that your tape library uses the default barcode reporting configuration or a configuration that reports the last two characters, not including the checksum. See [Configure Barcode Reporting on page 110](#) for details of the default barcode reporting configuration and instructions for changing the barcode configuration.

If the tape drive determines that the tape cartridge does not meet the unused criteria, the M8 initialization fails and the tape retains LTO-7 density. If the library or your storage management software reports an M8 initialization failure, Spectra Logic recommends replacing the barcode on the tape with an L7 barcode.

IMPORT AND EXPORT OVERVIEW

Importing cartridges into the library and exporting cartridges from the library are the primary interactions you have with the physical library. You import magazines filled with cartridges into the library during your initial setup, and both import and export cartridges during normal day-to-day backup operations.

Requirements

User Privilege Requirement Any user with operator privileges who is assigned to the partition and all users with superuser or administrator privileges can perform import or export operations. See [Specify the Partition Users on page 184](#) for information about assigning users to a partition.

Cartridge and Magazine Labeling Make sure that each cartridge and magazine is labeled with a unique barcode. The barcode labels on Spectra Certified Media contain information about the media type. To ensure that the correct type of cartridges are stored in a partition, the library prevents you from importing the wrong cartridge type into a partition.

TeraPack Magazines Cartridges are always imported and exported using a TeraPack magazine (or a maintenance magazine for cleaning partitions), regardless of whether you have an individual cartridge or a group of cartridges.

- When you want to import a single cartridge, you must first put the prepared cartridge in a magazine, then import the magazine.
- When you want to export a single cartridge, you must export the magazine containing the cartridge and remove the desired cartridge from the magazine. You can then reimport the magazine, if desired.

Restrictions

Using the BlueScale Web Interface (RLC) The import and export options are not available when you access the library using a remote connection to the BlueScale web interface (RLC). These operations are always performed from the local BlueScale user interface on the library operator panel.

Background Operations You cannot import, export, or exchange cartridges or magazines if the library is actively running a background operation such as Media Auto Discovery, PreScan, or PostScan.

If you do not want to wait for a Media Auto Discovery, PreScan, or PostScan operation to complete, you can stop the Media Auto Discovery or PreScan operation or pause the PostScan operation. For other background operations, wait for the process to complete.

- Click **Stop Discovery** on the Media Lifecycle Management Tools screen to stop a Media Auto Discovery or PreScan operation (see [Stop the Discovery Process on page 264](#)).
- Click **Pause PostScan** on the Media Lifecycle Management Tools screen to pause the PostScan operation for one hour (see [Pause the PostScan Process on page 272](#)).

Auto Discovery Media Auto Discovery and PreScan are background operations that use the drives in a partition to discover newly imported LTO cartridges and add them to the MLM database. The discovery process cannot begin while the hosts are actively loading cartridges into or unloading cartridges from the drives. If you import cartridges during this time, the library posts a failure message stating that no drives are available to perform the discovery process.

Either wait until the library is idle before beginning the import or manually start the discovery process for imported cartridges when the library is idle. See [Discover Cartridges Manually on page 262](#) for instructions.

IMPORTING INTO A STORAGE OR CLEANING PARTITION

Overview During normal operations, magazines containing data cartridges are typically imported to a storage partition's entry/exit pool and then moved to the storage pool using your storage management software. This process ensures that the media inventory maintained by the storage management software is accurate.

An exception is the first time that cartridges are loaded into a storage partition. Unless your storage management software requires you to use the software to perform all imports, importing magazines directly into a storage partition's storage pool simplifies loading a storage partition for the first time. After the cartridges are imported into the storage pool, they are available for immediate use by the storage management software.

Import Requirements

Partitions You must have one or more partitions defined before you can import magazines into the library. [Chapter 6 – Configuring and Managing Partitions](#), beginning on [page 159](#) provides detailed instructions for creating partitions.

Cartridges and Magazines All cartridges are imported into the library using magazines. Before beginning, have on hand the cartridges that you want to import into the partition. If necessary, prepare the cartridges as described in [Preparing Cartridges for Use on page 197](#).

If you are importing magazines into the storage partition's storage pool for the first time, the maximum number of magazines you need equals the number of chambers assigned to the storage pool for the partition (see [Creating a Storage Partition on page 169](#)). You do not need to fill all slots in the magazines or all of the chambers in the partition. However, any empty chambers are inaccessible to the storage management software.

Entry/Exit Pool For daily operations, TeraPack magazines containing data cartridges are typically imported or exported using a storage partition's entry/exit pool. When using the entry/exit pool for importing/exporting, the following must be true:

- The entry/exit pool must have sufficient empty chambers available for importing new magazines. If you need to import new magazines and all of the chambers in the entry/exit pool are full, you must export one or more magazines to make space for the new magazines (see [Export Magazines from a Partition on page 211](#)).
- The entry/exit pool must have sufficient empty slots available to accommodate any cartridges that the storage management software ejects from the partition. If all of the slots in the entry/exit pool are full, either move newly imported cartridges to the partition's storage pool, leaving empty slots in the entry/exit pool, or export one or more full magazines and replace them with magazines that have empty slots.



Important

Make sure that the magazines you export are not filled with cartridges that you just imported but did not yet move to the storage pool using your storage management software.

You can import a magazine containing a cleaning cartridge into the partition's entry/exit pool and then use the Inventory screen to move the cartridge to a drive for cleaning (see [Moving Cartridges Within a Partition on page 231](#)). When the cleaning is complete, move the cleaning cartridge back to the entry/exit pool and export the magazine from the entry/exit pool.

Storage Pool A storage partition's storage pool contains all of the cartridges that can be accessed by the storage management software for the purpose of writing or reading data.

- If you are importing magazines into the entry/exit pool and using your storage management software to move the cartridges to the storage pool, the storage pool must have sufficient empty slots to accommodate each cartridge imported into the entry/exit pool.
- If you are importing directly into the storage pool, the storage pool must have sufficient empty chambers to accommodate the magazines you plan to import.

- Any chambers in the storage pool that do not contain magazines are inaccessible to the storage management software. You can, however, import magazines into the empty chambers using the library's BlueScale user interface.

Cleaning Partition When importing cleaning cartridges into a cleaning partition, keep the following in mind:

- Cleaning cartridges must be identified with "CLN" at the beginning of the barcode sequence on their labels. This requirement applies to both standard and custom barcode labels.
- Cleaning cartridges used in a cleaning partition must be in Maintenance TeraPack magazines, which are identified by Spectra-unique labels. The library automatically prevents importing cleaning cartridges and magazines that are not properly labeled into a cleaning partition.

Note: Maintenance TeraPack magazines filled with appropriately labeled cleaning cartridges are available from Spectra Logic.

- Make sure that the Maintenance TeraPack magazine does not contain any data cartridges. The library does not import a Maintenance TeraPack magazine that contains cartridges that are not identified with "CLN" at the beginning of the barcode sequence on their labels.
- Make sure that you import only cleaning cartridges that are compatible with the drives in the storage partition associated with the cleaning partition. To ensure that the correct type of cleaning cartridges are stored in a cleaning partition, the library prevents you from importing the wrong cartridge type.
- The cleaning cartridges in a cleaning partition can only be used for drives in storage partitions configured to use that cleaning partition. Associating a cleaning partition with drives in a storage partition automatically enables the Auto Drive Clean feature for that partition.
- The cleaning cartridges in the cleaning partition are inaccessible to the application software running on the host. Make sure you disable any software-based drive cleaning to prevent repeated requests to import a cleaning cartridge.
- If your storage management software supports automated drive cleaning and you plan to use this method to clean the drives instead of the library's Auto Drive Clean feature, refer to your software documentation for instructions. You must import the properly labeled cleaning cartridges into the storage partition using a TeraPack magazine (*not* a Maintenance TeraPack magazine).

Additional Requirements and Restrictions See [Import and Export Overview on page 201](#) for information about additional requirements and restrictions when importing magazines and cartridges.

Prepare the Storage Partition or the Cleaning Partition

Before importing magazines into a storage partition or a cleaning partition, make sure that the partition has sufficient empty slots or chambers available to accommodate the cartridges or magazines you plan to import.

- If you plan to import cartridges into the storage partition's entry/exit pool, and then use your storage management software to move the cartridges to the storage pool, check the Inventory screen for the partition to make sure that the storage pool has an empty slot available to accommodate each imported cartridge (see [Viewing and Downloading the Cartridge Inventory on page 224](#)). If there are insufficient empty slots available in the storage pool, do one of the following to prepare the storage pool to receive the imported cartridges:
 - If the partition's storage pool has empty chambers, import one or more TeraPack magazines with empty slots into the storage pool (see [Import the Magazines on page 206](#)).
 - If the partition's storage pool does not have any magazines with empty slots, use your storage management software to eject cartridges from the library. The library moves the ejected cartridges from the partition's storage pool to magazines in its entry/exit pool. You can then export the magazines from the library (see [Export Magazines from a Partition on page 211](#)). The resulting empty slots in the storage pool are now available for newly imported cartridges.
 - Exchange a full magazine in the storage pool for one containing empty slots (see [Exchange Magazines or Cartridges in a Partition on page 212](#)).
- If you plan to import cartridges directly into the partition's storage pool, make sure that the storage pool has an empty chamber for each magazine you plan to import. The partition's Import/Export TeraPack Magazines screen shows the number of empty chambers available in the partition's storage pool (see [Figure 108 on page 206](#)). If there are no empty chambers available in the storage pool, export one or more magazines from the storage pool (see [Export Magazines from a Partition on page 211](#)).
- If you plan to import cleaning cartridges into a cleaning partition, make sure that there is an empty chamber for each maintenance magazine you plan to import. If there are no empty chambers available in the cleaning partition, export one or more magazines. Alternatively, you can exchange expired cleaning cartridges for new ones in the magazines already present in the cleaning partition without having to import additional magazines (see [Export or Exchange Expired Cleaning Cartridges on page 213](#)).

Import the Magazines

1. Log into the library as a user with the appropriate privileges (see [User Privilege Requirement](#) on page 201).
2. From the toolbar menu, select **General** ... **Import/Export**. The Import/Export TeraPack Magazines screen displays, showing the information for the last partition that was viewed on either the Import/Export TeraPack screen or the Inventory screen.
3. Select the partition and TAP you want to use from the drop-down lists, then click **Go**. The Import/Export TeraPack Magazines screen refreshes to show the current status of the chambers assigned to the selected partition.



Figure 108 Select the partition.

- Click the appropriate **Import** button to select the destination (the storage pool or entry/exit pool for a storage partition or cleaning for a cleaning partition) for the imported magazines.

Note: If there are no empty chambers in the selected pool, the **Import** button is not present. Export one or more magazines to make space for the new magazines.

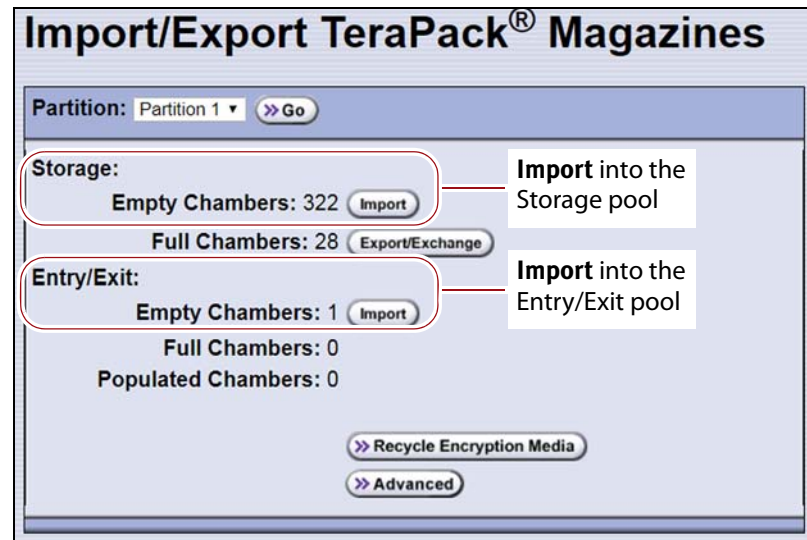

Figure 109 Click **Import** for the desired destination (storage partition shown).

For a...	Select Import for....	If you want to import...
Storage partition	Storage: Empty Chambers	Magazines into the storage pool.
	Entry/Exit: Empty Chambers	Magazines into the entry/exit pool. Note: Importing into the entry/exit pool is the recommended method (see Import and Export Overview on page 201).
Cleaning partition	Cleaning: Empty Chambers	Maintenance magazines into the cleaning partition.

- The top TAP door opens and a Feedback Required screen displays instructing you to place a TeraPack in the TAP.

- a. Insert a magazine into the tray on the open TAP, making sure that it is oriented with the textured surface on each side toward the outside of the library, as shown in [Figure 110](#).

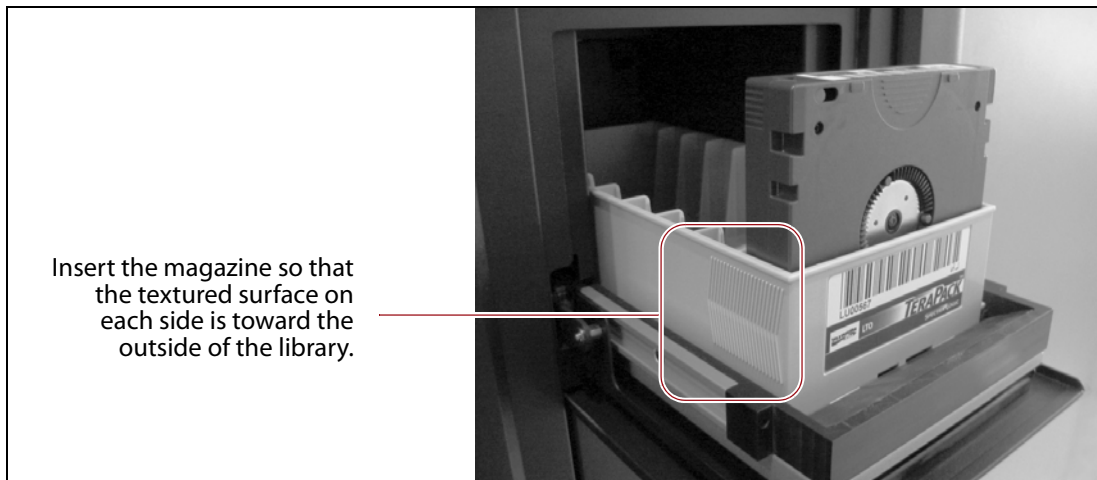

Figure 110 Insert a magazine into the TAP, making sure that it is correctly oriented.

- b. Return to the operator panel and select the appropriate option on the Feedback Required screen.

Note: If you wait more than 10 minutes to respond, the library times out and displays a message on the operator panel. The TAP door is left open.

Select...	If...
Continue	<p>You plan to import another magazine after the one currently in the TAP. The import process continues as follows:</p> <ol style="list-style-type: none"> 1. The TAP door closes automatically. The library retrieves the magazine from the TAP and moves it to a chamber in the selected destination. 2. If there are still empty chambers available in the selected destination, the TAP door opens, ready to accept the next magazine. 3. The import process continues as long as there are empty chambers available or until you click Stop Importing on the Feedback Required screen. Continue to insert magazines into the TAP, clicking Continue after each one. When there are no empty chambers remaining in the selected destination, the process stops automatically and the Import/Export TeraPack Magazines screen displays.
Stop Importing	The magazine you placed in the TAP is the last one you want to import.

Prepare the Entry/Exit Pool

After the storage management software moves the cartridges out of the entry/exit pool, export empty magazines to provide empty chambers for future import operations (see [Export Magazines from a Partition on page 211](#)). Be sure to leave at least one magazine with empty slots in it in the entry/exit pool. These empty slots are used for the cartridges that the library moves from the storage pool when the storage management software ejects cartridges from the partition. Over the course of time, normal operations typically result in the entry/exit pool containing at least one magazine with empty slots.



Important

If the entry/exit pool does not contain a magazine with sufficient empty slots, the storage management software halts its eject operation. You must exchange the full magazines in the entry/exit pool for empty ones, as described in [Exchange Magazines or Cartridges in a Partition on page 212](#), before retrying the eject operation.

If you plan to import additional cartridges, export empty magazines left in the entry/exit pool after the storage management software moves all of the previously imported cartridges to the storage pool. The resulting empty chambers are needed for future import operations (see [Export Magazines from a Partition on page 211](#)).



Important

Make sure that the magazines you export are not filled with cartridges that you just imported but that the storage management software has not yet moved to the storage pool.

If there are no magazines with empty slots in the entry/exit pool, follow the steps in [Exchange Magazines or Cartridges in a Partition on page 212](#) to exchange the full magazines for magazines that have empty slots.

EXPORTING OR EXCHANGING MAGAZINES AND CARTRIDGES

Overview This section provides instructions for exporting or exchanging all of the magazines and cartridges in a storage partition's entry/exit or storage pool or all of the maintenance magazines in a cleaning partition.

- Notes:**
- If you want to export or exchange a specific magazine or a specific cartridge, use the Advanced option, as described in [Using the Advanced Import/Export Options on page 216](#).
 - If you want to export or exchange a small number of cartridges, you can also use the Inventory screen to move the magazine containing the desired cartridge to the TAP so that you can remove or exchange an individual cartridge and then move the magazine back to its original location (see [Moving Cartridges Within a Partition on page 231](#)).

Requirements See [Import and Export Overview](#) on page 201 for information about requirements and restrictions when exporting or exchanging magazines.

Export process The *export* process uses the TAP to physically remove all of the magazines (and any cartridges they contain) from the selected location (a cleaning partition or a storage partition's entry/exit pool or storage pool). The exported magazines are not replaced by new magazines.

The following steps describe the process for exporting cartridges from a storage partition using the entry/exit pool. Using this method ensures that the media inventory maintained by the storage management software remains accurate.

1. Use your storage management software to tell the library to eject the cartridges from the library.
2. The library moves each cartridge out of the partition's storage pool and into an empty slot in a TeraPack magazine already stored in the entry/exit pool.
3. When all of the requested cartridges are moved to the entry/exit pool, the library reports to the software that the export request is complete.
4. At your convenience, you can then export the magazines in the entry/exit pool from the library using controls on the Import/Export TeraPack Magazines screen of the user interface and either the center TAP or left TAP.

Exchange process The *exchange* process moves each of the magazines in the selected location to either the TAP so that you can exchange the magazines for others of the same type.

You can also remove or exchange one or more individual cartridges in a magazine while leaving the other cartridges in place. Exchanging cartridges in a magazine is especially useful when you need to temporarily import a cleaning cartridge into the storage pool as part of drive maintenance.

Prepare for the Export or Exchange

- If you are exchanging cartridges or magazines, have on hand the prepared data cartridges and properly labeled magazines (see [Preparing Cartridges for Use](#) on page 197).
- **Recommended** If you want to export cartridges from a storage partition, use your storage management software to eject the desired cartridges from the partition's storage pool. You can then export the cartridges from the entry/exit pool. Using this method to export cartridges from a storage partition ensures that the media inventory maintained by the storage management software remains accurate.

- Exporting a magazine directly from the storage pool is not recommended unless you are exporting all of the magazines from a partition. This process is often referred to as a “bulk export.”

If you choose to export magazines directly from the storage partition’s storage pool, be sure to use your storage management software to update its media inventory after completing the export (see [Updating the Storage Management Software Inventory on page 222](#)).

Export Magazines from a Partition

1. Log into the library as a user with the privileges appropriate to the location from which you are exporting magazines (see [User Privilege Requirement on page 201](#)).
2. From the toolbar menu, select **General ... Import/Export**. The Import/Export TeraPack Magazines screen displays showing the information for the last partition that was viewed on either the Import/Export TeraPack Magazines screen or the Inventory screen.
3. Select the partition and TAP you want to use from the drop-down lists, then click **Go**.

The Import/Export TeraPack Magazines screen refreshes to show the current status of the chambers assigned to the selected partition.

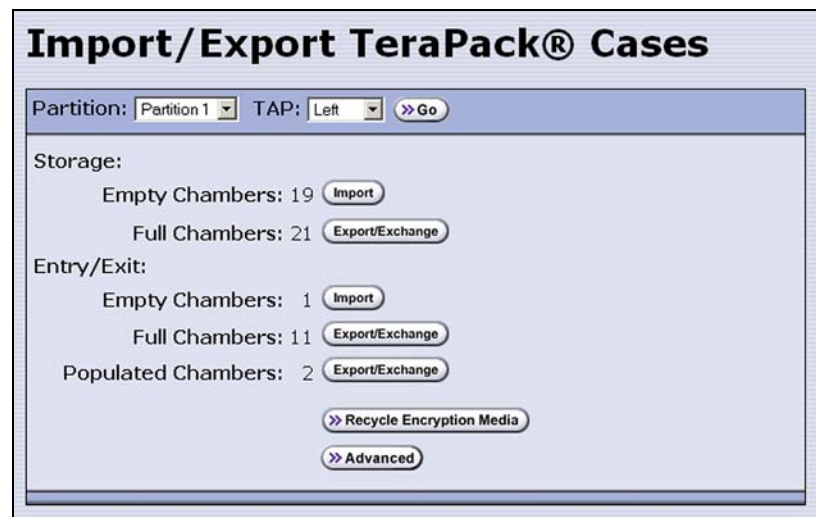

Figure 111 Use the Import/Export TeraPack Magazines screen to export or exchange magazines (storage partition shown).

- Click the appropriate **Export/Exchange** button to select the location from which you want to export or exchange magazines.

Note: If there are no full chambers in the selected location, the **Export/Exchange** button is not present.

For a...	Select Export/Exchange for...	If you want to export or exchange...
Storage partition	Storage: Full Chambers	All of the magazines in the storage pool.
	Entry/Exit: Full Chambers	All of the magazines in the entry/exit pool.
	Entry/Exit: Populated Chambers	Only the magazines in the entry/exit pool that contain one or more cartridges.
Cleaning partition	Cleaning: Full Chambers	All of the magazines in the cleaning partition.

The library retrieves a magazine from the specified pool and places it in the TAP. The TAP door opens and a Feedback Required screen displays.

- Remove the magazine from the open TAP and set it aside.
- Return to the operator panel and select the appropriate option on the Feedback Required screen.

Note: If you wait more than 10 minutes to respond, the library times out and displays a message on the operator panel. The TAP door is left open.

Select...	If...
Continue	You want to export another magazine. The process continues as follows: <ol style="list-style-type: none"> The TAP door closes automatically when you click Continue. The library retrieves the next magazine and delivers it to the TAP. The export process continues as long as there are magazines in the selected location or until you click Stop Exporting on the Feedback Required screen. Continue to remove the magazines and click Continue after each one. When all of the magazines in the selected location are exported, the process stops automatically and the Import/Export TeraPack Magazines screen displays.
Stop Exporting	The magazine you removed from the TAP is the last one you want to export.

Exchange Magazines or Cartridges in a Partition

The process for exchanging a magazine or cartridges in a partition is the same as that for exporting a magazine up to the point where the magazine is delivered to the TAP.

Note: If you want to exchange only the expired cleaning cartridges in a cleaning partition, skip to [Export or Exchange Expired Cleaning Cartridges](#) on page 213.

- Complete [Step 1 on page 211](#) through [Step 4 on page 212](#) to begin the exchange process.

When you click **Export/Exchange**, the library retrieves a magazine from the selected location and places it in the TAP. The TAP door opens and a Feedback Required screen displays.

2. Remove the magazine from the TAP and either:

- Place another magazine of the same type in the TAP.

— OR —

- Remove or exchange one or more cartridges in the magazine and then place the magazine back in the TAP.

Note: If you are exchanging cartridges, make sure to only exchange cartridges of the same type.

3. Return to the operator panel and select the appropriate option on the Feedback Required screen.

Note: If you wait more than 10 minutes to respond, the library times out and displays a message on the operator panel. The TAP door is left open.

Select...	If...
Continue	You want to make additional exchanges. The process continues as follows: <ol style="list-style-type: none"> 1. The TAP door closes automatically. The library returns the magazine to its original location. It then retrieves the next magazine and delivers it to the TAP. 2. The exchange process continues as long as there are magazines in the selected location or until you click Stop Exporting on the Feedback Required screen. Continue to make exchanges, clicking Continue after each one. When all of the magazines in the selected location are presented for exchange, the process stops automatically and the Import/Export TeraPack Magazines screen displays.
Stop Exporting	The magazine or cartridge you exchanged is the last one you want to process.

Export or Exchange Expired Cleaning Cartridges

The export and exchange processes described in this section only operate on Maintenance TeraPack magazines that contain expired cleaning cartridges. The Maintenance TeraPack magazines are always stored in a cleaning partition.

1. Log into the library as a user with superuser or administrator privileges.
2. From the toolbar menu, select **General**  **Import/Export**. The Import/Export TeraPack Magazines screen displays showing the information for the last partition that was viewed on either the Import/Export TeraPack Magazines screen or the Inventory screen.

3. Select the desired cleaning partition and then click **Go**. The Import/Export TeraPack Magazines screen refreshes to show the current status of the chambers assigned to the partition.
4. Click **Export/Exchange Expired** on the Import/Export TeraPack Magazines screen.



Figure 112 Select **Export/Exchange Expired**.

5. The library retrieves a magazine that contains expired cleaning cartridges from the cleaning partition and places it in the TAP. The TAP door opens and a Feedback Required screen displays, indicating which cartridges to remove from the magazine.
 - a. Remove or exchange the expired cleaning cartridges indicated on the Feedback Required screen.
 - b. Place the magazine back in the TAP if you removed it.

6. Return to the operator panel and click the appropriate option on the Feedback Required screen.

Note: If you wait more than 10 minutes to respond, the library times out and displays a message on the operator panel. The TAP door is left open.

Click...	If...
Continue	<p>You <i>removed</i> the expired cleaning cartridges in the magazines and did not replace them with new cartridges. Also click Continue if you <i>removed</i> or <i>exchanged</i> the entire magazine. The process continues as follows:</p> <ol style="list-style-type: none"> 1. The TAP door closes automatically. If you exchanged magazines, the library first moves the new magazine into the cleaning partition. It then retrieves the next magazine from the cleaning partition and delivers it to the TAP. <p>Note: If you <i>exchanged</i> cartridges and clicked Continue instead of Override, click Ok in response to a message stating that the slot containing the exchanged cartridge should be empty.</p> <ol style="list-style-type: none"> 2. The process continues as long as there are magazines with expired cleaning cartridges in the cleaning partition or until you click Stop Exporting on the Feedback Required screen. Remove the expired cartridges from each magazine, place the magazine back into the TAP, and click Continue for each one. When there are no expired cleaning cartridges left in the cleaning partition, the process stops automatically and the Import/Export TeraPack Magazines screen displays.
Override	<p>You <i>exchanged</i> the expired cleaning cartridges in the magazine for new ones. The process continues as follows:</p> <ol style="list-style-type: none"> 1. The TAP door closes automatically. The library moves the magazine in the TAP back to the cleaning partition. It then retrieves the next magazine from the cleaning partition and delivers it to the TAP. 2. The process continues as long as there are magazines with expired cleaning cartridges in the cleaning partition or until you click Stop Exporting on the Feedback Required screen. Exchange the expired cartridges in each magazine, place the magazine back into the TAP, and click Override for each one. When there are no expired cleaning cartridges left in the cleaning partition, the process stops automatically and the Import/Export TeraPack Magazines screen displays.
Stop Exporting	<p>The expired cleaning cartridge you removed or exchanged is the last one you want to process.</p>

USING THE ADVANCED IMPORT/EXPORT OPTIONS

Overview The Advanced option on the Import/Export TeraPack Magazines screen lets you import a magazine into a specific chamber in a partition or export a specific magazine from a partition.

Note: If you only need to import or export a single cartridge, you can also use the options on the Inventory screen (see [Chapter 8 – Using the Cartridge Inventory](#), beginning on [page 223](#)). This chapter also provides instructions for moving cartridges from one location to another within a partition.

Requirements When using the advanced import/export options, keep the following in mind:

- Only a user with superuser or administrator privileges can access the advanced import/export options.
- Refer to the following sections for additional requirements and restrictions:
 - [Import and Export Overview on page 201](#)
 - [Importing into a Storage or Cleaning Partition on page 202](#)
 - [Exporting or Exchanging Magazines and Cartridges on page 209](#)

Populate the Import/Export move queue using one of the following:

- [Manually Create a Move Queue on page 216](#)
- [Upload a Move Queue on page 219](#)

Manually Create a Move Queue

1. If you want to import one or more cartridges, place the prepared cartridges in an empty TeraPack magazine (see [Preparing Cartridges for Use on page 197](#)).
2. Log into the library as a superuser or administrator.
3. From the toolbar menu, select **General**  **Import/Export**. The Import/Export TeraPack Magazines screen displays showing the information for the last partition that was viewed on either the Import/Export TeraPack Magazines screen or the Inventory screen.

4. Click **Advanced**. The Advanced Import/Export screen displays showing the information for the partition that was selected on the basic Import/Export TeraPack Magazines screen.



Figure 113 Access the advanced import/export options.

5. On the Advanced Import/Export screen, use the drop-down lists to select the partition and the direction you want to move the magazine, then click **Go**.

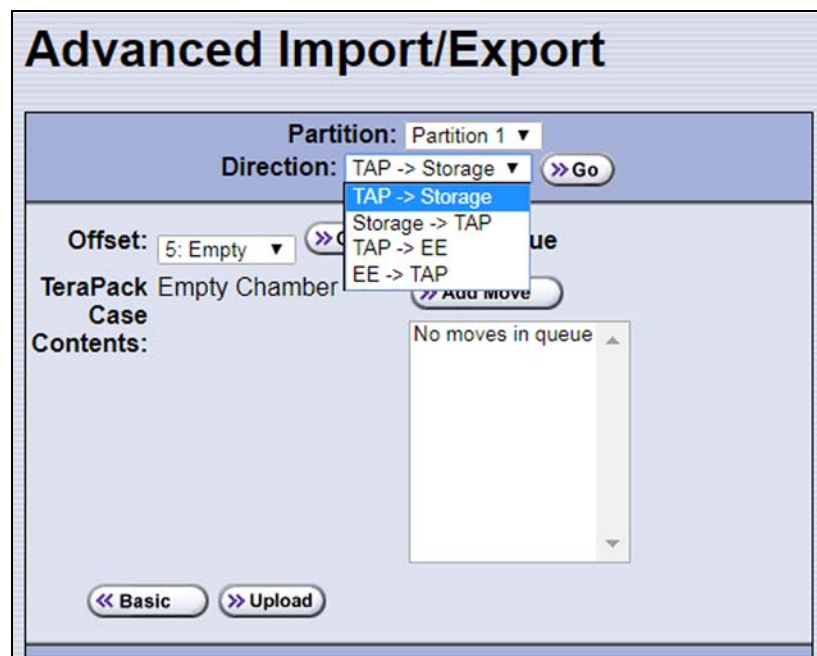

Figure 114 Select the partition and the direction of the move.

Select the direction

For a...	Select...	To move the magazine from...
Storage partition	TAP → Storage	The TAP to the selected chamber in the storage pool.
	Storage → TAP	The selected chamber in the storage pool to the TAP.
	TAP → EE	The TAP to the selected chamber in the entry/exit pool.
	EE → TAP	The selected chamber in the entry/exit pool to the TAP.
Cleaning partition	TAP → Storage	From the TAP to the selected chamber in the cleaning partition.
	Storage → TAP	From the selected chamber in the cleaning partition to the TAP.
	TAP → EE EE → TAP	For a cleaning partition, the options for moving to or from the entry/exit pool are not valid.

6. Use the **Chamber** drop-down list to select the source chamber for the move and then click **Go** to refresh the screen.
 - For moves to the TAP from either the entry/exit or storage pool, the selected chamber is the source for the move. The **TeraPack Case Contents** list shows the barcodes of the cartridges in the magazine in the selected chamber.
 - For moves from the TAP to either the entry/exit or storage pool, the selected chamber is the destination for the move. Use the **Chamber** drop-down list to select an empty chamber in the selected pool.
7. Click **Add Move**.

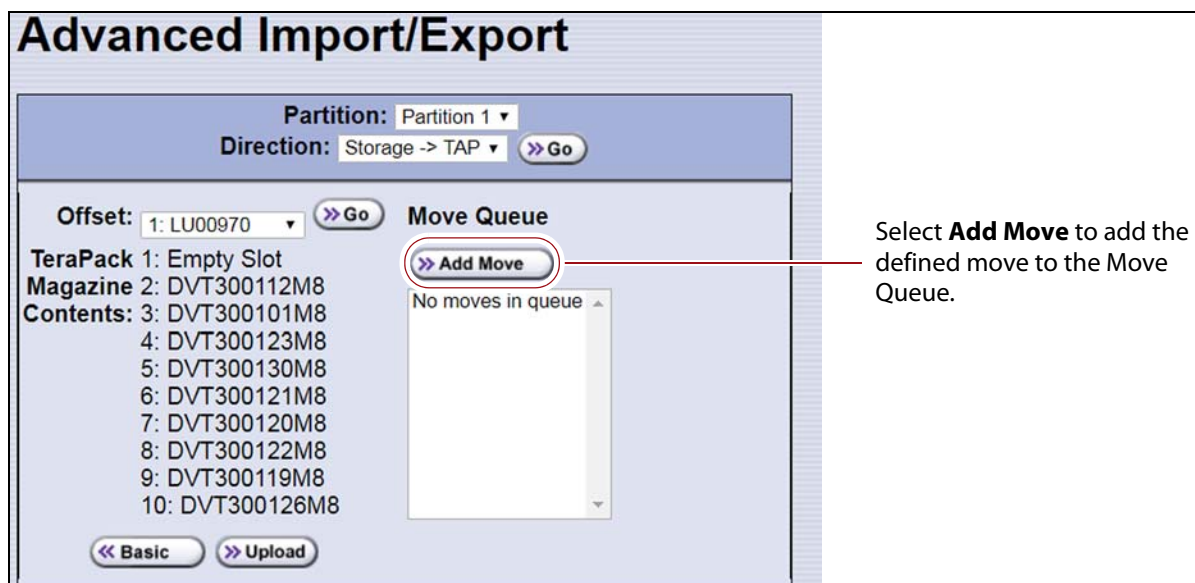



Figure 115 Add the move to the Move Queue.

An entry listing the move you just defined appears in the Move Queue list.

8. Repeat [Step 5 on page 217](#) through [Step 7 on page 218](#) to add more moves to the Move Queue.
Notes:
 - Changing the selected partition clears the move queue.
 - You can add moves from different directions to the same move queue.
 - If you do not want to perform one or more of the moves in the queue, do the following:
 - Select the move and click **Delete** to remove it from the Move Queue list.
 - Click **Delete All** to remove all of the defined moves from the Move Queue list.
9. Continue with [Start the Moves on page 222](#).

Upload a Move Queue

1. Create a media exchange move file listing the offsets for the imports or exports you want to initiate. You can create the file using the `mediaExchange.xml?action=prepareImportExportList` command (see the *Spectra Tape Libraries XML Command Reference* for more information) or manually. If you are creating the move file manually, keep the following in mind:
 - The file must be an ASCII text file.
 - Each line in the file must contain a 1-based TeraPack offset.
 - All chambers indicated by the offsets in a file must be full indicating an export, or all chambers must be empty indicating an import. You cannot mix import and export moves in one file.
 - If you are using a USB device to upload the file, the file must be named `MediaExchangeMoves.txt` and the file must be saved to the root of the USB device.
2. Log into the library as a superuser or administrator.
3. If you saved the move queue file to a USB device, connect the device to one of the USB ports on the LCM or operator panel and allow time for the device to mount before proceeding.
4. Access the Upload Media Exchange Move List screen.
Using RLC, from the toolbar menu, select **General**  **Import/Export**. The Upload Media Exchange Move List screen displays.
— OR —

Access the Upload Media Exchange Move List screen from the front panel.

- a. On the toolbar menu, select **General**  **Import/Export**. The Import/Export TeraPack Magazines screen displays showing the information for the last partition that was viewed on either the Import/Export TeraPack Magazines screen or the Inventory screen.
- b. Click **Advanced**. The Advanced Import/Export screen displays showing the information for the partition that was selected on the basic Import/Export TeraPack Magazines screen.
- c. On the Advanced Import/Export screen (see [Figure 115 on page 218](#)), click **Upload**. The Upload Media Exchange Move List screen displays.

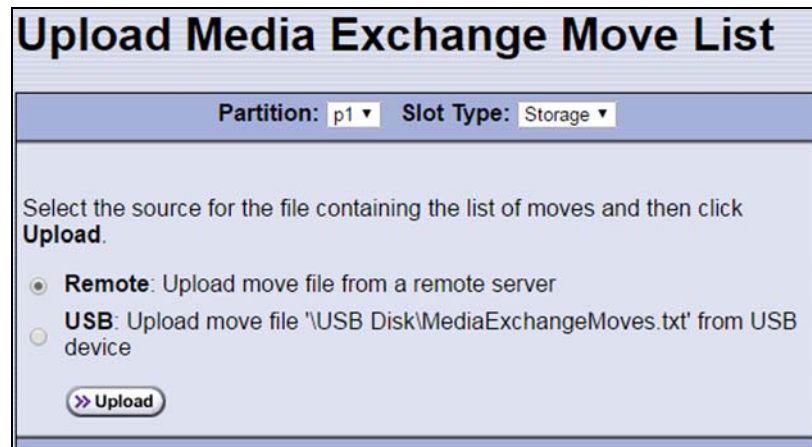



Figure 116 Add the move to the Move Queue.

5. Select the **Partition** from which you want to export, or to which you want to import, TeraPack magazines.
6. Select whether to move magazines to, or from, the **Storage** pool or entry/exit (**EE**) pool.
7. Select the desired option for uploading the move queue file.

Select...	To...
Remote	Upload the move queue file using the BlueScale web interface. Note: This option is only available if your are logged in using the RLC.
USB	Upload the move queue file from a USB device connected to the LCM or operator panel.  Important: The move queue file must be named <code>MediaExchangeMoves.txt</code> . The library does not recognize any other file name. The file must be stored in the root of the USB device.

8. Click Upload.

- If you selected **USB**, the Advance Import/Export screen displays. Continue with [Step 9 on page 221](#).
- If you selected **Remote**, the RLC Upload Media Exchange Move File screen displays. Use your web browser's upload feature to find the file, and then click **Next**. The Advanced Import/Export screen displays with a new button labeled **Populate**.

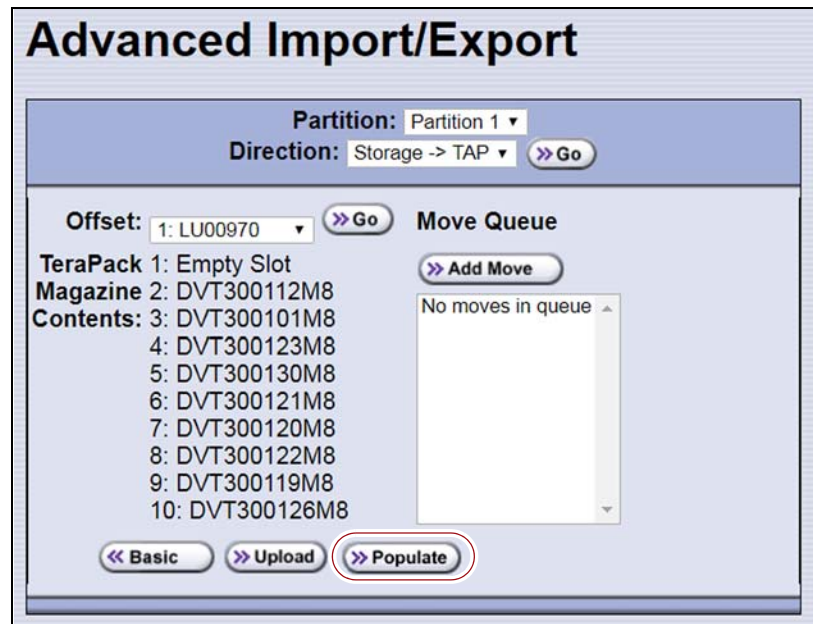

Figure 117 The Advanced Import/Export screen with the **Populate** button.

- 9.** Click **Populate** to add the imports or exports in the media exchange move file to the move queue.
- 10.** Continue with [Start the Moves on page 222](#).

Start the Moves

1. Click **Start Moves** to begin processing the moves. The TAP door opens.
2. Depending on the direction of the move, either remove the magazine or insert a magazine.
3. Return to the operator panel and select one of the following options on the Feedback Required screen.

Note: If you wait more than 10 minutes to respond, the library times out and displays a message on the operator panel. The TAP door is left open.

Select...	To...
Continue	<p>Process the next move in the queue.</p> <ol style="list-style-type: none"> 1. The TAP door closes automatically and the library performs the next move. 2. The TAP door opens and a Feedback Required screen displays waiting for you to remove or insert a magazine. 3. The process continues until all of the moves in the queue are processed or until you click Stop Exporting on the Feedback Required screen. Continue to remove or insert a magazine in the TAP, clicking Continue for each one. When all of the defined moves are completed, the process stops automatically and the Advanced Import/Export TeraPack Magazines screen displays.
Stop Exporting	Stop processing the move queue.

UPDATING THE STORAGE MANAGEMENT SOFTWARE INVENTORY

As the library imports magazines, it reads the barcode labels on the individual cartridges and the magazines and automatically updates the physical inventory that it maintains. This process does not automatically update the media inventory maintained and used by the storage management software.

The storage management software maintains its own media inventory, which it uses when performing backup/restore operations and for media management. To avoid errors when the storage management software requests a specific cartridge, be sure to use your storage management software to update its media inventory whenever you import cartridges into or export/exchange cartridges from a storage partition's storage pool as described in this chapter. Refer to your software documentation for more information.

CHAPTER 8

Using the Cartridge Inventory

This chapter describes using the library's cartridge inventory to identify and move cartridges within the library. See [Chapter 7 – Importing and Exporting Cartridges](#), beginning on [page 196](#) for information about importing and exporting magazines and cartridges.

Topic	
Understanding the Cartridge Inventory	page 224
Viewing and Downloading the Cartridge Inventory	page 224
View the Cartridge Inventory for a Location	page 225
Download the Cartridge Inventory	page 227
Locating a Specific Cartridge	page 231
Moving Cartridges Within a Partition	page 231
Move Cartridges Using the BlueScale Inventory Screen	page 232
Upload and Process the Move Queue File	page 240

UNDERSTANDING THE CARTRIDGE INVENTORY

The inventory is a record of all the cartridges stored in each library partition and their current locations (for example, in a specific slot in a TeraPack magazine, or in a drive). As cartridges are imported into a partition, the barcode reader on the transporter reads the barcode labels on the individual cartridges and the magazines. The library uses this barcode information to maintain its physical inventory, which is stored in the RCM.

The Inventory screen, available from the General toolbar, lets you interact with the cartridge inventory in the following ways:

If you want to...	The inventory screen lets you...
View information about the cartridges in a partition,	<ul style="list-style-type: none"> ▪ View the cartridges located in a storage partition's storage pool, its entry/exit pool, or a drive. ▪ View the cartridges located in a cleaning partition and identify expired cartridges. An "x" appears next to the slot number if the cleaning cartridge is expired. ▪ Download an XML file that lists the inventory of every location in the selected storage partition (see Download the Cartridge Inventory on page 227).
Locate a specific cartridge in the partition,	Search for a cartridge using either its barcode label information or its slot location (see Locating a Specific Cartridge on page 231).
Move a cartridge from one location to another,	<ul style="list-style-type: none"> ▪ Find and select a specific cartridge within a partition and move it to another location (see Moving Cartridges Within a Partition on page 231). ▪ Automate a series of moves in a storage partition by uploading a specially formatted ASCII text file that contains a sequence of moves to the partition (see Create a Move Queue File on page 237).

VIEWING AND DOWNLOADING THE CARTRIDGE INVENTORY

Overview The Inventory screen provides information about the cartridge inventory for each of the partitions configured in the library. It also provides options for interacting with that inventory to move cartridges from one location to another.

Requirements When using the Inventory screen, keep the following requirements in mind:

- Any user with operator privileges who is assigned to the partition and all users with superuser or administrator privileges can view and download the cartridge inventory.
- Downloading an XML file containing the current cartridge inventory for a partition requires either a remote connection to the library using the BlueScale web interface (RLC) or a USB device connected to the library.

View the Cartridge Inventory for a Location

Note: You can also view the cartridge inventory for a specific location using the Media Lifecycle Management Report screen (see [Using MLM Reporting](#) on page 273).

1. Log into the library.
2. From the toolbar menu, select **General** ... **Inventory**. The Inventory screen displays, showing the information for the last partition that was viewed on either the Import/Export TeraPack Magazines screen or the Inventory screen.
3. Select the partition for which you want to view the inventory from the **Partition** drop-down list, then click **Go**. The screen refreshes to show the cartridge inventory for the **Source** type that was selected the last time the Inventory screen was viewed.

Note: The **Destination** list shows all of the empty locations of the selected type.

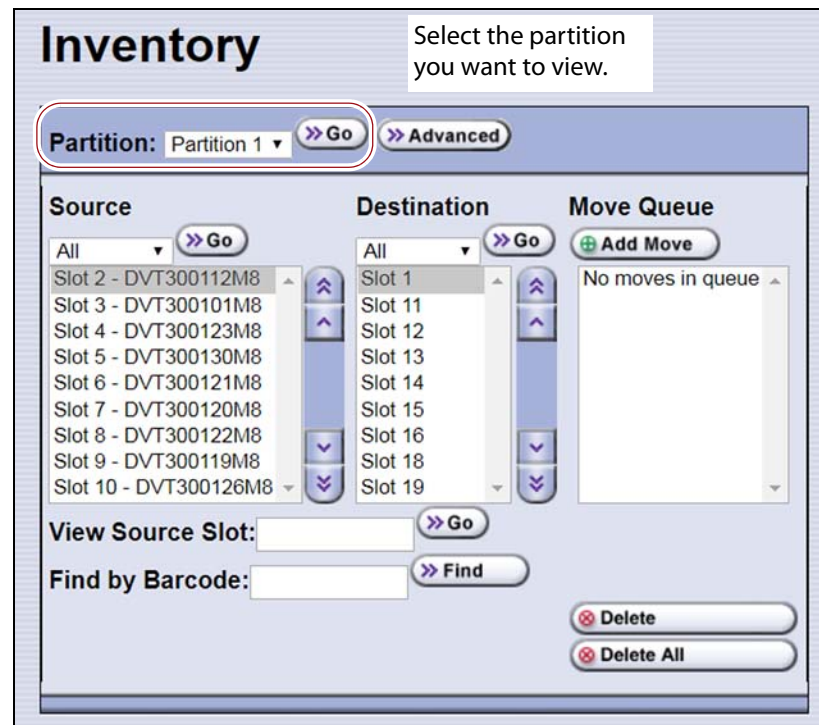

Figure 118 The Inventory screen.

- Use the **Source** drop-down list to select the location for which you want to view the cartridge inventory, then click **Go**. The **Source** list refreshes to display a list of the cartridges in the requested location type.

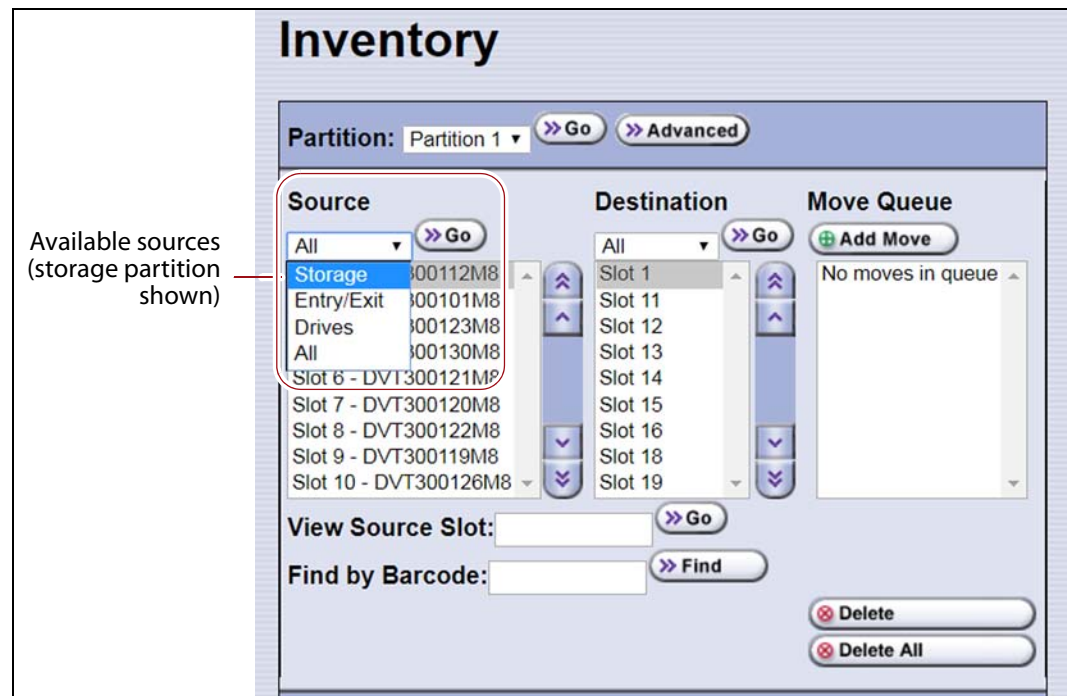

Figure 119 Select the source type for which you want to view the inventory.

- Notes:**
- The available sources depend on the type of partition selected.
 - If the selected source does not contain any cartridges, the source list shows “No sources found.”
 - The **From TAP** option is only available when you access the user interface from the operator panel.

Partition Type	Available Sources
Storage	<ul style="list-style-type: none"> Storage — Lists the barcodes of the cartridges currently in the selected partition’s storage pool. Entry/Exit — Lists the barcodes of the cartridges currently in the partition’s entry/exit pool. Drives — Lists the barcode of the cartridge currently in each drive assigned to the partition. Only drives that contain a cartridge are included in the list. From TAP — Configures a move that transfers the magazine containing the destination slot to the TAP so that you can insert a cartridge (see Moving Cartridges Within a Partition on page 231). All — Lists all of the cartridges in the partition, regardless of location.

Partition Type	Available Sources
Cleaning	<ul style="list-style-type: none"> ▪ Cleaning — Lists the cleaning cartridges currently in the selected cleaning partition. ▪ From TAP — Configures a move that transfers the magazine containing the destination slot to the TAP so that you can insert a cartridge (see Moving Cartridges Within a Partition on page 231). ▪ All — Lists all of the cartridges in the partition, regardless of location. <p>Note: If an “x” appears next to the slot number in the source list for a cleaning partition, the cleaning cartridge is expired.</p>

Download the Cartridge Inventory

If desired, you can download the inventory for the selected partition as an XML file. You can use the information in the downloaded inventory when creating a move queue file (see [Create a Move Queue File on page 237](#)).

- If you are using the BlueScale user interface from the operator panel, the cartridge inventory is saved as an XML file on a USB device that is connected to the LCM or the operator panel.
- If you are accessing the library using the BlueScale web interface, the cartridge inventory is displayed using the XML format in a new browser window on the computer that you are using to access the library. From there you can save the file to a convenient location for later use. If a USB device is connected to the LCM or operator panel, you can also save the XML file to the USB device.

The inventory lists the following information for all magazine slots in the partition’s storage pool and entry/exit pool and for the drives in the partition.

- For each slot and drive, the list shows the location ID and indicates whether or not it is full (occupied).
- For each occupied slot or drive, the list also indicates the barcode information of the cartridge.

Note: You can also use the XML command interface to obtain the full inventory of the partition, including both full and empty slots and drive numbers (see `inventory.xml` in the [Spectra Tape Libraries XML Command Reference](#)).

Usage Requirements Downloading an XML file containing the current cartridge inventory requires either a remote connection to the library using the BlueScale web interface (RLC) or a USB device connected to the LCM or operator panel.

Download the Inventory Use the following steps to download the inventory.

1. Log into the library.
2. If you want to save the XML file containing the cartridge inventory to a USB device, connect the device to the USB port on the LCM or the operator panel and allow time for the device to mount before proceeding (see [Connect a USB Device to the Library on page 158](#)).
3. From the toolbar menu, select **General ... Inventory**. The Inventory screen displays, showing the information for the last partition that was viewed on either the Import/Export TeraPack Magazines screen or the Inventory screen.
4. If you want to download the inventory for a partition other than the one currently displayed, select the desired partition from the **Partition** drop-down list, then click **Go** (see [Figure 118 on page 225](#)).
5. Click **Advanced** to display the options for uploading moves and downloading the inventory.

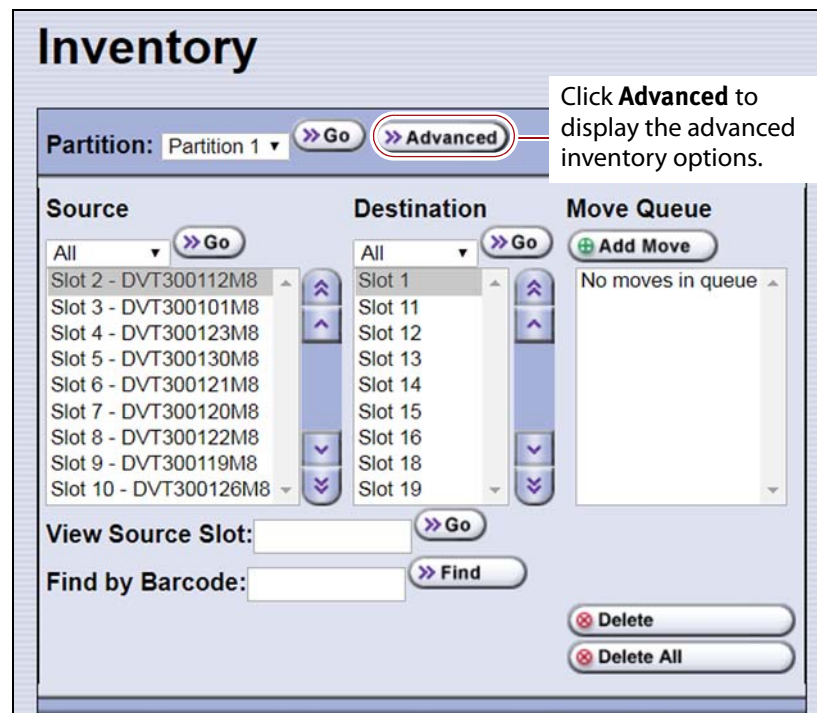

Figure 120 Click **Advanced** to display the advanced options for the selected partition.

- On the Advanced Inventory screen, select the **Download Inventory** tab.



Important

The option to download the inventory file to a USB device is grayed out if the USB device is not connected and given time to mount before you click **Advanced** on the inventory screen.



Figure 121 Select the download option for the inventory file.

- Select the desired option for downloading the inventory file. As soon as you make your selection, the download process begins.

Click...	To...
Remote Browser	<p>Automatically open the XML file on the computer accessing the library's BlueScale web interface.</p> <p>Notes:</p> <ul style="list-style-type: none"> This option can only be selected if you are accessing the library using the BlueScale web interface (RLC). If the application associated with XML files is a web browser, the XML file opens in a new browser window.
USB	<p>Save the XML file to the root of the USB device connected to the LCM or operator panel. The file name uses the following format: <code>[Partition Name]_[yyyy-mm-dd]_[hh_mm_ss].xml</code></p> <p>Note: This option can only be selected if you connected a USB device to the library before you clicked Advanced.</p>

- If the XML file was successfully saved to the USB device or if the library detected errors, a Download Verification screen displays. If errors are reported, resolve them and then repeat the download process.

Note: The Download Verification screen does not display if the file successfully downloads to the remote computer.

9. Open the XML file.

- If you selected the **Remote Browser** option for downloading the XML file, the file opens automatically. You can then save the file to your computer for later use.

Note: See `inventory.xml` in the *Spectra Tape Libraries XML Command Reference* for a description of the fields in the XML file.

```
<?xml version="1.0" ?>
<inventory>
  <partition>
    <name>Partition 1</name>
    <storageSlot>
      <id>4096</id>
      <full>no</full>
    </storageSlot>
    <storageSlot>
      <id>4097</id>
      <barcode>039641L5</barcode>
      <isQueued>no</isQueued>
      <full>yes</full>
    </storageSlot>
    <storageSlot>
      <id>4098</id>
```

Figure 122 The cartridge inventory XML file opened in a web browser.

- If you selected the USB option, move the USB device to a computer and open the XML file.
- To view the XML file in spreadsheet format, use Microsoft Excel® 2007 or later, or use another spreadsheet program that supports the XML file format.

	A	B	C	D	E	F	G	H	I	J
1	name	id	full	barcode	isQueued	id2	barcode3	isQueued4	full5	
2	Partition 1	4096	no			256	031321L4	no	yes	
3	Partition 1	4097	yes	039641L5	no	256	031321L4	no	yes	
4	Partition 1	4098	no			256	031321L4	no	yes	
5	Partition 1	4099	yes	000549L4	no	256	031321L4	no	yes	
6	Partition 1	4100	yes	000885L4	no	256	031321L4	no	yes	
7	Partition 1	4101	no			256	031321L4	no	yes	
8	Partition 1	4102	no			256	031321L4	no	yes	
9	Partition 1	4103	no			256	031321L4	no	yes	
10	Partition 1	4104	yes	042229L4	no	256	031321L4	no	yes	
11	Partition 1	4105	yes	000609L4	no	256	031321L4	no	yes	
12	Partition 1	4106	yes	000795L4	no	256	031321L4	no	yes	
13	Partition 1	4107	yes	000507L4	no	256	031321L4	no	yes	
14	Partition 1	4108	yes	000766L4	no	256	031321L4	no	yes	
15	Partition 1	4109	yes	000813L4	no	256	031321L4	no	yes	
16	Partition 1	4110	yes	000501L4	no	256	031321L4	no	yes	
17	Partition 1	4111	yes	000547L4	no	256	031321L4	no	yes	
18	Partition 1	4112	no			256	031321L4	no	yes	
19	Partition 1	4113	yes	000743L4	no	256	031321L4	no	yes	
20	Partition 1	4114	yes	000787L4	no	256	031321L4	no	yes	

Figure 123 Example of the cartridge inventory XML file opened in Excel.

LOCATING A SPECIFIC CARTRIDGE

The Inventory screen provides three different methods for locating a specific cartridge in the library.

1. Log into the library.
2. Display the cartridge inventory for the desired partition location (see [View the Cartridge Inventory for a Location on page 225](#)).
3. Locate the desired cartridge using one of the following methods.

To locate using...	Do the following...
The Source list,	<ol style="list-style-type: none"> 1. Scroll through the list until you find the barcode for the desired cartridge. 2. Click the barcode to select the cartridge.
The slot number,	<ol style="list-style-type: none"> 1. Enter the slot number for the cartridge you want in the View Source Slot field. 2. Click Go. The Source list refreshes to show the requested slot highlighted at the top of the list. 3. Click the cartridge to select it.
The barcode label information,	<ol style="list-style-type: none"> 1. Enter the barcode label information for the cartridge you want to locate in the Find by Barcode field. 2. Click Find. The Source inventory list refreshes to show the requested cartridge highlighted at the top of the Source list. 3. Click the barcode to select the cartridge. <p> Important: Only the slots below the top one displayed in the list are searched. Scroll to the top of the source list before clicking Find. The search starts at the second visible slot.</p>

MOVING CARTRIDGES WITHIN A PARTITION

Overview During normal operations, you typically use your storage management software to move cartridges from one location to another within the library. However, you may occasionally need to create and process a move queue to move cartridges manually. This can be done using the library's BlueScale interface to locate and move individual cartridges (for example, to move a cleaning cartridge stored in the storage partition to a drive if you are not using the Auto Drive Clean option) or by uploading a series of moves to a storage partition using a specially formatted ASCII text file. Use the instructions in one of the following sections to manually direct cartridge moves.

- [Move Cartridges Using the BlueScale Inventory Screen on page 232](#)
- [Move Cartridges Using an ASCII Move File on page 237](#)

User Privilege Requirements The user privilege requirements when moving cartridges in a storage partition depend on how the library is being accessed. See [Specify the Partition Users on page 184](#) for information about assigning users to a partition.

- Any user with operator privileges who is assigned to the partition and all users with superuser or administrator privileges can move cartridges within the partition using the BlueScale interface on the operator panel.
- Only a user with superuser or administrator privileges can move cartridges within the partition using the BlueScale web interface (RLC) or upload a move queue file.

Usage Requirements Uploading a move queue file requires either a remote connection to the library using the BlueScale web interface (RLC) or a USB device connected to the LCM or operator panel.

Move Cartridges Using the BlueScale Inventory Screen

The library uses a move queue to direct tape cartridge moves. The move queue lists one or more source/destination pairs, with each pair representing a single move operation.

Manually Create the Move Queue Use the following steps to create the move queue using the BlueScale Inventory screen.

1. Log into the library as a user with the required privileges (see [User Privilege Requirements](#) above).
2. Display the cartridge inventory for the desired partition location.
 - a. From the toolbar menu, select **General ... Inventory**.
 - b. Select the partition for which you want to view the inventory from the **Partition** drop-down list, then click **Go**.
3. Use the **Source** drop-down list to select the source type for the move, then click **Go**.

- Notes:**
- Selecting a specific source type instead of using **All** displays fewer items through which you must scroll to locate the desired cartridge.
 - The **From TAP** option is only available when you access the user interface from the front panel.
 - The TAP only contains cartridges while an import or export operation is in progress. Cartridges are not stored in the TAP.

- If you select **Entry/Exit** from the **Source** drop-down list and there are cartridges in the entry/exit pool, a **Bulk Load** button displays at the bottom of the Inventory screen. Clicking **Bulk Load** automatically adds operations to the move queue for moving each cartridge in the entry/exit pool to an empty slot in the storage pool.

Partition Type	Available Sources
Storage	<ul style="list-style-type: none"> ▪ Storage — Lists the cartridges currently in the selected storage partition's storage pool. ▪ Entry/Exit — Lists the cartridges currently in the partition's entry/exit pool. ▪ Drives — Lists the drives in the partition that currently contain a cartridge. ▪ From TAP — Configures a move that transfers the magazine containing the destination slot to the TAP so that you can insert a cartridge. The magazine is then returned to its original location. ▪ All — Lists all of the cartridges in the partition, regardless of location.
Cleaning	<ul style="list-style-type: none"> ▪ Cleaning — Lists the cleaning cartridges currently in the selected cleaning partition. ▪ From TAP — Configures a move that transfers the maintenance magazine containing the destination slot to the TAP so that you can insert a cartridge. The magazine is then returned to its original location. ▪ All — Lists all of the cartridges in the partition.

4. If you are moving a cartridge that is already in the library, locate and select the cartridge you want to move in the **Source** list, as described in [Locating a Specific Cartridge on page 231](#).

- Use the **Destination** drop-down list to select the type of location to which you want to move the cartridge, then click **Go**. The destination list refreshes to show all of the empty slots in the selected location.



Important

You cannot use the Inventory screen to move a cleaning cartridge in a cleaning partition to a drive in a storage partition. Instead, use the **Clean** button on the Drives screen (see [Manually Cleaning a Drive](#) on page 416).

- Notes:**
- The available destinations depend on the type of partition you selected.
 - The **To TAP** option is only available when accessing the BlueScale user interface from the front panel.

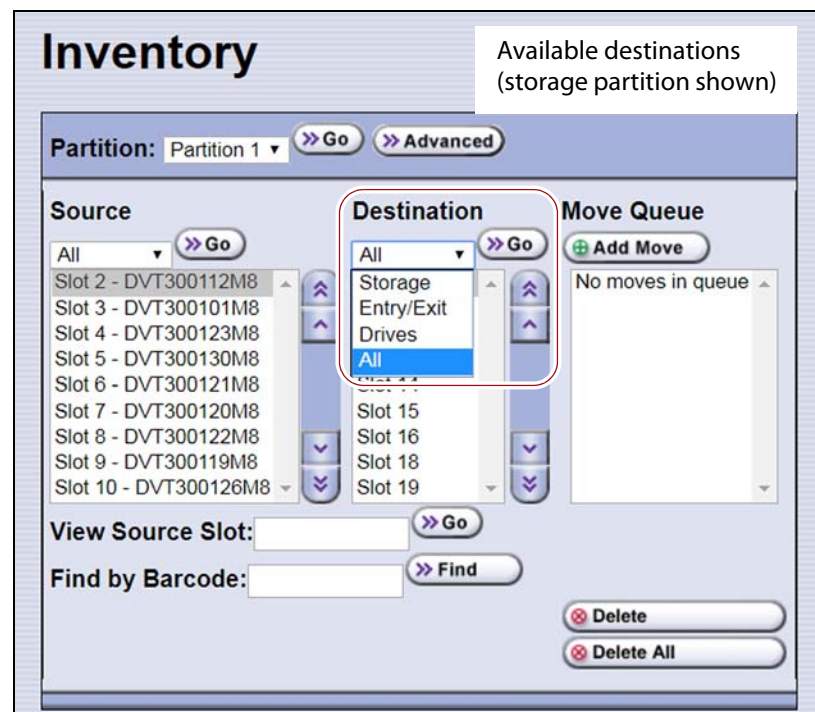
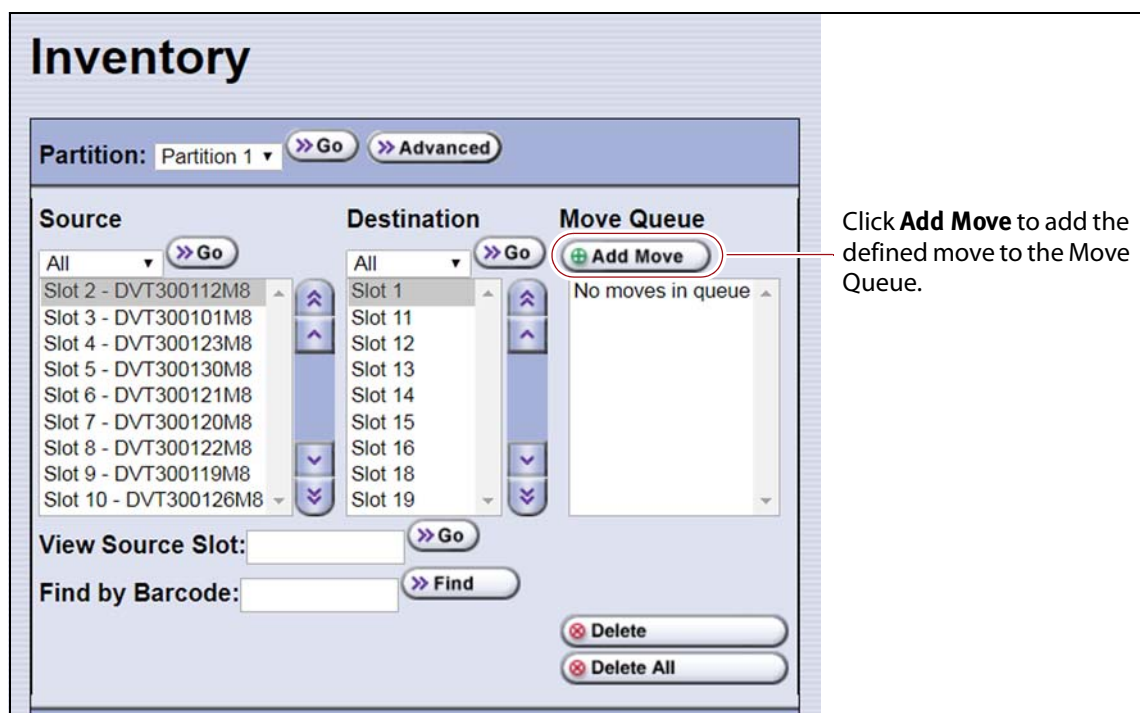

Figure 124 Select the Destination for the cartridge.

Partition Type	Available Destinations
Storage	<ul style="list-style-type: none"> Storage — Lists all of the empty slots in the selected storage partition's storage pool. Entry/Exit — Lists all of the empty slots in the selected partition's entry/exit pool. To TAP — Configures a move that transfers the magazine containing the source slot to the TAP so that you can remove the cartridge from the specified slot. The magazine is then returned to its original location. Drives — Lists the drives in the partition that are currently empty. All — Lists all of the empty slots in the partition, regardless of the location. <p>Note: Selecting a specific destination type instead of using All displays fewer items through which you must scroll to locate the desired destination slot.</p>

Partition Type	Available Destinations
Cleaning	<ul style="list-style-type: none"> ▪ Cleaning — Lists all of the empty slots in the selected cleaning partition. ▪ To TAP — Configures a move that transfers the maintenance magazine containing the source slot to the TAP so that you can remove or replace the cleaning cartridge from the specified slot. The magazine is then returned to its original location. ▪ All — List all available destinations in the partition, regardless of the type. <p>Note: Selecting a specific destination type instead of using All displays fewer items through which you must scroll to locate the desired destination slot.</p>

6. If you are moving a cartridge to a slot, locate and select the desired slot in the Destination list.
7. Click **Add Move**.



Click **Add Move** to add the defined move to the Move Queue.

Figure 125 Add the move to the Move Queue.

An entry listing the move you just defined appears in the Move Queue list.

8. Repeat [Step 3 on page 232](#) through [Step 7 on this page](#) for each additional cartridge you want to move.

Note: If you want to remove one or more of the moves in the queue:

- Select the move and click **Delete** to remove it from the Move Queue list.
- Click **Delete All** to remove all of the defined moves from the Move Queue list.

Process the Move Queue Use the following steps to process the move queue created using the Inventory screen.

1. If you are moving cartridges into the library, prepare the cartridges as described in [Prepare the Cartridges for Use on page 199](#).

Note: When importing cartridges, you do not need to put the prepared cartridges into a magazine. You are prompted to insert the prepared cartridge into the selected empty slot in the magazine that is delivered to the TAP.

2. Choose one of the move processing modes:

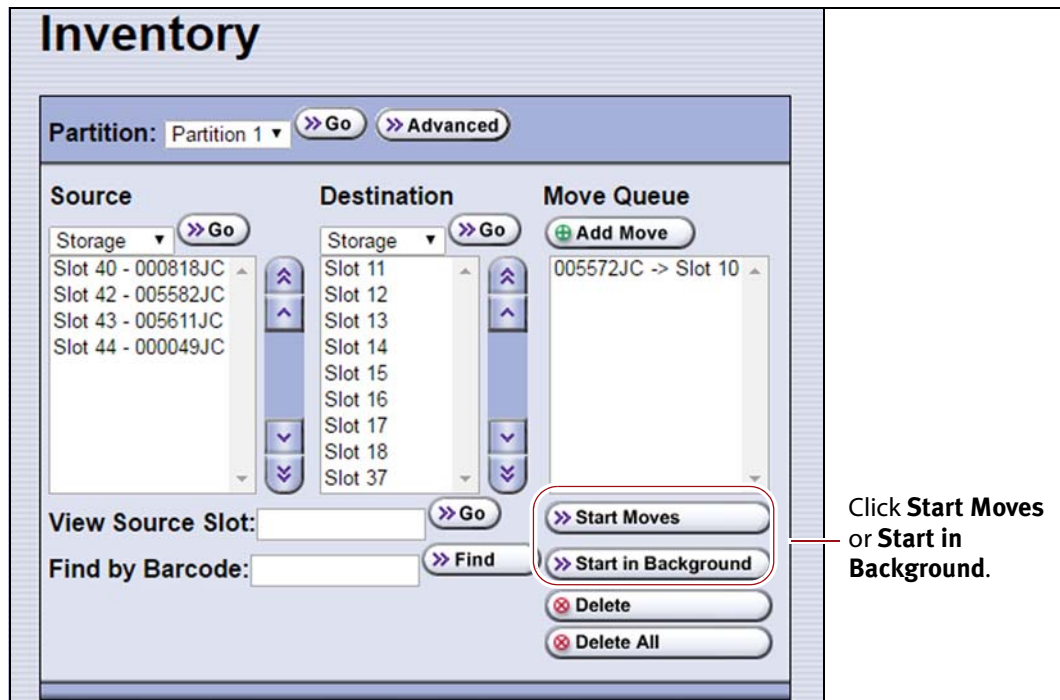

Figure 126 Click **Start Moves** or **Start in Background** to begin processing the move queue.

Click...	To...
Start Moves	<p>Begin processing the moves in the order that they are listed in the queue. A progress screen tracks the progress of the move operations. When all of the moves in the queue have been processed, the screen displays the status of each move. No other operations can be started until the moves complete.</p> <p>Note: If the TAP is the source for or destination for a move, a Feedback Required screen displays.</p> <ul style="list-style-type: none"> ▪ From TAP — The magazine containing the destination slot is moved to the TAP so that you can insert a cartridge in the slot indicated by the Feedback Required screen. The magazine is then returned to its original location. ▪ To TAP — The magazine containing the source slot is moved to the TAP so that you can remove or replace the cartridge from the slot indicated by the Feedback Required screen. The magazine is then returned to its original location.

Click...	To...
Start in Background	<p>Begin processing the moves in the background. The front panel or RLC is available for some operations.</p> <p>Notes:</p> <ul style="list-style-type: none"> ▪ You are not able to edit the partition, import or export cartridges into the partition, or create another move queue for the partition while background moves are in progress. ▪ Start in Background is not available if the move queue includes moves to or from the TAP. ▪ The library posts informational messages after every 10 moves in the move queue and when the all moves complete.

3. When the moves complete, use your storage management software to update the inventory it maintains, if necessary (see [Updating the Storage Management Software Inventory on page 222](#)).

Move Cartridges Using an ASCII Move File

Create a Move Queue File If desired, you can create an ASCII text file that lists sources and destinations for a series of moves and upload that move queue file to the library. This option is particularly useful if you need to move a large number of cartridges.



Important

The maximum number of moves that can be configured in a single move queue is 100 source/destination pairs.



Important

The barcode for a cartridge can only be used as the source in the first move of that cartridge in a connected sequence of moves. The remaining moves in the sequence must specify either a slot or a drive as the source. For example, in a sequence that moves a cartridge from a storage slot to a drive and then back to the storage slot, only the move from the slot to the drive can use the barcode as the source.

- Notes:**
- The option to upload a move queue file is only available for storage partitions.
 - Moves to or from the TAP are not supported.

1. Use one of the following methods to obtain an inventory listing for the partition in which you plan to move the cartridges:
 - Download the partition inventory using the **Advanced** option on the Inventory screen (see [Download the Cartridge Inventory on page 227](#)).
 - Download the partition inventory using the XML command interface. See the *Spectra Tape Libraries XML Command Reference* for a detailed description of each parameter in the downloaded inventory file.

Note: Both methods return the same information.

- Using an ASCII text editor, create a file containing the list of moves you want to configure. Each line of the move queue file must specify a source and destination separated by a delimiter.

The format of each line is:

```
[source_id][source_num][delimiter][destination_id]
[destination_num]
```

where:

Note: The slot numbers and drive numbers are assigned by the library.

For this variable...	The possible values are...	Description...
source_id	<ul style="list-style-type: none"> ▪ SLOT — The cartridge is moved from a slot in the storage pool. ▪ EE — The cartridge is moved from a slot in the entry/exit pool. ▪ DRIVE — The cartridge is moved from the drive. ▪ BC — The cartridge to be moved is identified by its barcode label information. <p>Note: The values are not case-sensitive.</p>	Specifies the location type for the source from which you want to move the cartridge.
source_num	<ul style="list-style-type: none"> ▪ A positive integer for all <i>source_id</i> values except BC. ▪ The human-readable barcode label character string if the <i>source_id</i> is BC. <p> Important: If the cartridge does not have a valid barcode label, then you must specify both the element type for the <i>source_id</i> and the number of the slot in the entry/exit or storage pool or the number of the drive where the cartridge is located for the <i>source_num</i>.</p>	<p>Specifically identifies the cartridge to be moved, either by the ID of the slot or drive where it is currently located or by the barcode label on the cartridge.</p> <ul style="list-style-type: none"> ▪ If the <i>source_id</i> is SLOT or EE, this value is the number assigned to the slot where the cartridge is currently located. Locate the <offset> parameter for the desired cartridge in the downloaded inventory file and use that value as the <i>source_num</i>. ▪ If the <i>source_id</i> is DRIVE, this value is the number of the drive where the cartridge is currently located. Locate the <offset> parameter for the drive in the downloaded inventory file and use that value as the <i>source_num</i>. ▪ If the <i>source_id</i> is BC, this value is the human-readable barcode character string for the cartridge to be moved. Locate the <barcode> parameter for the desired cartridge in the downloaded inventory file and use that value as the <i>source_num</i>.

For this variable...	The possible values are...	Description...
delimiter	; (semicolon) : (colon) Note: Either character is acceptable.	The character that separates the source from the destination.
destination_id	<ul style="list-style-type: none"> ▪ SLOT — The cartridge is moved to an empty slot in the storage pool. ▪ EE — The cartridge is moved to an empty slot in the entry/exit pool. ▪ DRIVE — The cartridge is moved to the specified drive. Note: The values are not case-sensitive.	Specifies the location type for the destination of the cartridge move.
destination_num	A positive integer.	Specifies the ID of the location to which the cartridge is moved. <ul style="list-style-type: none"> ▪ An empty slot in the entry/exit or storage pool for the partition ▪ The number of the drive Locate the <offset> parameter for the desired slot or drive in the downloaded inventory file and use the value as the <i>destination_num</i> .

Example The following lines in a move queue file specify a series of moves.

This line in the file...	Moves...
BC000618L3;Slot3	The cartridge with barcode label 000618L3 to slot 3 of the storage pool.
Slot10;EE5	The cartridge in slot 10 of the storage pool to slot 5 in the entry/exit pool.
EE10;Slot15	The cartridge in slot 10 of the entry/exit pool to slot 15 in the storage pool.
Drive3;Slot18	The cartridge in Drive 3 to slot 18 of the storage pool.
BC000742L3;Drive1	The cartridge with barcode label 000742L3 to Drive 1.

3. Examine the move queue file carefully to make sure that each line is formatted correctly and contains both a source and a destination. When the library parses the uploaded file, it will reject the file if it contains any syntax errors.
4. Save the move queue file as an ASCII text file.

Note: If you plan to use a USB device to upload the move queue file, save the file to the root of the drive using the file name `MoveQueue.txt`.

Upload and Process the Move Queue File After you finish creating the move queue file, use the following steps to upload and process the file.

1. Log into the library as a user with superuser or administrative privileges.
2. If you saved the move queue file to a USB device, connect the device to one of the USB ports on the LCM or operator panel and allow time for the device to mount before proceeding (see [Connect a USB Device to the Library on page 158](#)).



Important

The option to upload the move queue file from a USB device cannot be selected if the USB device is not connected and mounted before you click **Advanced** on the inventory screen.

3. From the library user interface, select **General**  **Inventory**. The Inventory screen displays showing the information for the last partition that was viewed on either the Inventory screen or the Import/Export TeraPack Magazines screen.
4. If you want to upload the move queue to a storage partition other than the one currently displayed, select the desired partition from the **Partition** drop-down list, then click **Go**.

Note: Using a move queue file is only supported for storage partitions.

5. Click **Advanced** to display the options for uploading and processing the move queue file (see [Figure 120 on page 228](#)).
6. On the Advanced Inventory screen, select the **Upload Moves** tab.



Figure 127 Select the upload options for the move queue file.

7. Select the desired option for uploading the move queue file.

Select...	To...
Remote	Upload the move queue file using the BlueScale web interface.
USB	Upload the move queue file from a USB device connected to the LCM or operator panel.  Important: The move queue file must be named <code>MoveQueue.txt</code> . The library does not recognize any other file name. The file must be stored in the root of the USB device.

8. Click the button that describes how you want the file processed.

Click...	To...
Upload to Move Queue	Upload the file to the library. Once uploaded, you can view the parsed move queue file in the Move Queue list on the Inventory screen to review the uploaded moves. After reviewing the Move Queue, choose one of the following: <ul style="list-style-type: none"> Click Start Moves to begin processing the moves in the order that they are listed in the queue. The front panel is locked while the library processes the moves. Click Start in Background to begin processing the moves without locking the front panel.
Upload and Start Moves	Upload the file to the library and begin the moves immediately. No other operations can be started until the moves complete.
Upload and Start in Background	Upload the file and start the moves in the background. The front panel or RLC is available for some operations. Notes: <ul style="list-style-type: none"> The library posts informational messages after every 10 moves in the move queue and when the all moves complete. You are not able to edit the partition, import or export cartridges into the partition, or create another move queue for the partition while background moves are in progress.

- If you selected the USB option, the library retrieves the move file from the USB device.
- If you selected the **Remote** option, the RLC Upload Files screen displays. Use your web browser's upload feature to find the file, and then click **Next**.



Figure 128 Locate the move queue file and select it (Internet Explorer shown).

9. After the move queue file uploads, the library parses the file to create the move queue.

The parser ignores blank lines and case where possible. It does not determine whether the moves or the order of the moves is possible. If the parser encounters any parsing errors which are insurmountable or if the file contains syntax errors, the library rejects the move file and generates a system message indicating that the move file contained errors and listing the line numbers where the errors were detected.

For example, if line 1 in the MoveQueue.txt file uploaded from the USB device is BC000618L3;Slot, the library posts the following message indicating that the line did not include a value for destination_num:

```
-----  
File \USB Disk \ MoveQueue.txt has invalid moves in its list  
Invalid Parse on line 1: BC000618L3;Slot  
-----
```

If the library detected an error in the move file, correct the move file (see [Create a Move Queue File on page 237](#)) and then repeat [Step 2 on page 240](#) through [Step 8 on page 241](#).

10. The library then processes the moves based on your selection in [Step 8 on page 241](#).

CHAPTER 9

Configuring and Using Media Lifecycle Management

This chapter describes how to use BlueScale Media Lifecycle Management to proactively monitor and report on the health of the cartridges in your library. See [MLM Best Practices on page 451](#) for information about using Media Lifecycle Management (MLM) effectively in your environment and ensuring that your MLM data is protected.

Topic	
BlueScale Media Lifecycle Management	page 244
Spectra Certified MLM-Enabled Media	page 244
Automatic Media Discovery	page 245
Media Tracking and Reporting	page 247
MLM PreScan and PostScan	page 250
Additional MLM Features	page 251
Enabling MLM and Configuring Global Settings	page 253
Enable MLM and Configure Settings	page 253
Configure How Storage Capacity Displays	page 257
Configure PostScan Blackout Periods	page 258
Using Media Lifecycle Management	page 260
Add Cartridges to the MLM Database	page 260
Discover Cartridges Manually	page 262
Stop the Discovery Process	page 264
Using PreScan	page 264
Using PostScan	page 265
Operational Overview	page 265
Address Requirements for Use	page 269
Enable PostScan	page 270
Request a Manual PostScan	page 270
Pause the PostScan Process	page 272

Topic	
Using MLM Reporting	page 273
Generate MLM Reports	page 273
Save an MLM Report	page 278
Override a Poor Cartridge Health Report	page 280
Managing the MLM Database	page 281
Back Up the MLM and DLM Databases	page 282
Verify the Database Backup File	page 284
Delete MLM Records From the Database	page 284
Download the MLM Database for Analysis and Archival	page 287

BLUESCALE MEDIA LIFECYCLE MANAGEMENT

This section describes the major features of BlueScale Media Lifecycle Management (MLM). The remainder of the chapter provides detailed information about configuring and using MLM.

Overview BlueScale Media Lifecycle Management (MLM) helps you manage your tape media (cartridges) by giving you tools to proactively detect potential media errors well before they happen. When used in combination with Spectra Certified MLM-enabled media, MLM lets you manage, track, and report all facets of tape usage from creation to retirement. When used with media that is not MLM-enabled, MLM tracks and reports the general health of the media.

Spectra Certified MLM-Enabled Media

Media Lifecycle Management starts with packaged, barcode labeled, Spectra Certified MLM-enabled media. Before shipment, Spectra Logic writes baseline data to the MAM (Medium Auxiliary Memory) embedded in each cartridge. Throughout its life, the cartridge MAM continually collects data to support MLM tracking and reporting. See [Spectra Certified Media on page 466](#) for additional information.

Note: TS11xx technology cleaning tapes are always treated as MLM-enabled by the BlueScale software.

Automatic Media Discovery

Overview The Media Auto Discovery feature is a background process that loads MLM-enabled cartridges into a TS11xx technology or LTO drive, records the MLM information to the cartridge MAM, adds the cartridge to the MLM database, and returns the cartridge to its original location. The process is performed by the library independently from the storage management software. Media Auto Discovery must be enabled on the library, as described in [Enabling MLM and Configuring Global Settings on page 253](#), before it can be used.

Note: If you do not want to use automatic media discovery, you can wait until the library loads and then unloads each cartridge from an MLM-capable drive for the first time during normal operation. When the cartridge is unloaded from the drive, the library discovers it and records the MLM data to the cartridge MAM and enters the data into the MLM database.

When Media Auto Discovery is enabled, MLM provides two options for proactively discovering media in a partition:

- **Media Auto Discovery** — The default process that collects information from the cartridge MAM and adds it to the MLM database. The Media Auto Discovery process only operates on newly imported cartridges that are not already in the MLM database.

Note: Media Auto Discovery loads and reads the MAM in the tape, but does not thread the tape. The drive only reports the maximum and remaining capacity for the tape after the tape is threaded. Therefore, these statistics report as "0" until a drive reads from, or writes to, the tape.

- **PreScan** — An optional process that replaces Media Auto Discovery. If the PreScan feature is enabled in a partition, the PreScan process runs instead of the Media Auto Discovery process and operates on all of the media in the partition, regardless of whether it is already in the MLM database or not.

In addition to adding information collected from the cartridge MAM to the MLM database, PreScan performs a basic functionality test and health check on each imported cartridge (see [Using PreScan on page 264](#) for more information).

Discovery Process The discovery process can either be manually initiated by you or set to run automatically so that the library discovers the cartridges and adds their information to the MLM database shortly after a cartridge is imported into the library. The discovery process is independent of any storage management software.

The discovery process depends on whether the library is using Media Auto Discovery or PreScan. With Media Auto Discovery the library reads the barcode label on each new cartridge in the partition; with PreScan the library reads the barcode label on every cartridge in the partition. If a barcode is not already in the MLM database, the library loads the cartridge into a drive and performs either a PreScan or the basic Media Auto Discovery.

- If the cartridge is MLM-enabled, the library collects the available MLM information from the cartridge's MAM, including the born-on date. If the cartridge was used previously, the library also collects media health and encryption status from the MAM. The library updates the MLM database to include the collected information and the name of the partition where it currently resides. Any updated MLM information is also written to the MAM in the cartridge.
- If the cartridge is not MLM-enabled, the library collects the cartridge barcode label information, the cartridge health information, and the name of the partition where the cartridge currently resides. It then adds this information to the MLM database.

When the discovery process is complete, the drive unloads the cartridge and the library returns the cartridge to its original location. Each subsequent load/unload updates the MLM database and the cartridge MAM, providing ongoing tracking and reporting for the cartridge.

Manual Discovery If Media Auto Discovery is not enabled or if you enabled MLM when the library already contained cartridges, you can start the media discovery process manually to add the cartridges to the MLM database (see [Discover Cartridges Manually on page 262](#)).

Note: After you enable Media Auto Discovery, importing a cartridge into a partition triggers the discovery process in that partition.

Automatic Discovery During Normal Operations Automatic media discovery cannot begin while the library is actively loading cartridges into drives. If you import cartridges during this time, the library posts a failure message stating that no drives are available.

To avoid this failure, either wait until the library is idle before importing media or start the manual discovery process for the imported media when the library is idle. See [Discover Cartridges Manually on page 262](#) for instructions.

Media Tracking and Reporting

Overview MLM uses the information from the cartridge's MAM to maintain a database of vital information about each MLM-enabled cartridge in the library, including the drives into which it was loaded and any errors it encountered. The statistical and diagnostic information in the MLM database helps you proactively manage your tape media throughout its life. Using the information in the database, MLM can generate a variety of reports that let you monitor important health information about every MLM-enabled data cartridge and cleaning cartridge in your library. If desired, you can save the reports to a USB device or email them to a previously configured mail user. You can also download the MLM database as a comma-separated-value (CSV) file.

- Notes:**
- The MLM database also includes limited information about cartridges that are not MLM-enabled.
 - The cartridge inventory is separate from the MLM database and only shows cartridges currently stored in the library. The cartridge inventory does not differentiate between MLM-enabled and non-MLM-enabled cartridges.

Discovery Requirement Until an MLM-enabled cartridge is discovered, either through the automatic media discovery process or when it is loaded into and then unloaded from a drive for the first time, it is not included in the MLM database; nor is the capacity of a non-discovered data cartridge included on the Filled Capacity bar graph shown on the General Status screen.

Media Health Score The initial load/unload during discovery establishes an initial media health score for each cartridge and adds this information to the MLM database. This initial health score may not accurately reflect the actual health of the media. The health score stabilizes and becomes more accurate after the first four loads/unloads as current usage statistics are updated and used in the tape's health scoring.

MLM Health Reports MLM reports let you review important health information about every MLM-enabled data tape and cleaning tape in your library. You can generate comprehensive health reports for the MLM-enabled media in the whole library or in an individual partition. You can also generate more detailed reports with information about compression ratios, load counts, write errors, remaining capacity, encryption status, and more.

The MLM reports help you identify tapes with high error rates or other problems (for example, a dropped leader pin) that pose a risk to protecting your data. These tapes can then be removed before they cause data corruption or other problems. See [Generate MLM Reports on page 273](#) for detailed information about the types of reports you can generate.

MLM Database Management After a cartridge is added to the MLM database, its MLM data remains in the database even if the cartridge is exported from the library. If the cartridge is later reimported, the MLM database is updated to reflect any new information obtained from the cartridge MAM. When a cartridge is permanently removed from service, it can be manually deleted from the database.

The MLM database is restricted to a maximum of 75,000 records. When this limit is reached, the record for the least recently exported cartridge, as determined by the Export Date tracked by MLM, is automatically deleted. The library does not notify you when it reaches the maximum number of records.

To ensure that you have a complete record of all the cartridges that are used in the library, regularly generate and export a Media Health report for the entire library (see [Using MLM Reporting on page 273](#)). When a cartridge is retired or permanently exported from the library, its record can be deleted from the MLM database. Records can be deleted individually or as a group (see [Delete MLM Records From the Database on page 284](#)).

If desired, the information in the MLM database can be exported to a comma-separated-value (CSV) file, which can then be imported into Microsoft Excel[®] or other software applications that support this file type (see [Download the MLM Database for Analysis and Archival on page 287](#)).

Data Cartridge Tracking

A primary function of MLM is to track the health and usage of the data cartridges that are currently in or were previously in the library.

Functional Overview Each time a Spectra Certified MLM-enabled data cartridge is loaded into a drive, MLM records over 30 data points about the cartridge. These data points include health information, the cartridge age, how many times it was loaded and into which drives, and how many errors it accumulated. It also records when the cartridge is exported from the library and by whom. Each MLM-enabled data cartridge has a unique identifier that allows each cartridge to be tracked throughout its life, even if its barcode label is damaged or removed.

Remaining Capacity Calculations In addition to media health, the library uses information in the MLM database to estimate the Remaining Capacity report for the cartridges in the selected partition. If the partition contains a mix of MLM and non-MLM-enabled data cartridges, the report only shows the estimated capacity on the MLM-enabled cartridges.

Note: Until a data cartridge is loaded into, threaded, and then unloaded from a drive for the first time, its remaining capacity is not included in the Remaining Capacity report.

Cleaning Cartridge Tracking

Functional Overview The library tracks expired cleaning cartridges in the cartridge inventory and does not attempt to use an expired cleaning cartridge. Expired cleaning cartridges are identified by an “x” next to the slot number on the Inventory screen.

When you enable MLM and use Spectra Certified MLM-enabled cleaning cartridges, MLM tracks and reports usage information for the cleaning cartridges. This information, which includes the number of cleans remaining and the cartridge health (good, near expiration, or expired), is stored in the MLM database.

When a cartridge is nearing the end of its useful life, MLM notifies you so that you can have another on hand to replace it. This early notification helps prevent failed cleanings resulting from using an expired cleaning cartridge. See [Enabling MLM and Configuring Global Settings on page 253](#) for information about setting the threshold for generating the notification.

Note: TS11xx technology cleaning tapes are always treated as MLM-enabled by the BlueScale software.

Expired MLM-Enabled Cleaning Cartridges Each time an MLM-enabled cleaning cartridge is used in a drive, the drive decrements the number of cleans remaining on the cartridge. When the cartridge is unloaded from the drive, MLM reads the number of cleans remaining from the cartridge MAM. When the number of cleans remaining reaches zero, the library flags the cartridge as expired and does not attempt to use the cartridge again. Because the library does not need to load a cleaning cartridge into a drive to determine that it is expired, cleaning failures due to an expired cartridge are eliminated (assuming the cleaning partition contains a good cleaning cartridge). Information about an expired cleaning cartridge remains in the MLM database even after the cartridge is exported from the library.

Expired Non-MLM Cleaning Cartridges When MLM is not enabled or if the cleaning cartridges are not MLM-enabled, the library must load the cleaning cartridge into a drive to determine whether it is expired. When an expired cleaning cartridge is loaded into a drive, it is immediately ejected; the cleaning fails. The library flags the cleaning tape as expired in the cartridge inventory and generates system messages to notify you of the expired cleaning tape and the failed drive cleaning. The library does not attempt to use the expired cartridge for subsequent cleanings.

The library does not store any information about non-MLM cleaning cartridges in the MLM database. The library retains the information about an expired cleaning cartridge for as long as it remains in the library or until the library is power-cycled. If an expired non-MLM cartridge is exported and then reimported into the library, the cartridge must be loaded into a drive in order to identify it as expired.

MLM PreScan and PostScan

Overview MLM PreScan and PostScan are configurable background processes that use a drive to provide two levels of verification for data cartridges. See [Using PreScan on page 264](#) and [Using PostScan on page 265](#) for detailed information about configuring and using PreScan and PostScan.

Note: PostScan and Spectra SKLM or KMIP encryption key management cannot be configured for use in the same partition.

Enable and Configure PreScan and PostScan Both PreScan and PostScan are enabled and configured as part of the partition creation process, as described in [Enable and Configure MLM PreScan and PostScan on page 178](#). During configuration you set the scanning frequency and select the types of scan you want to use.

Usage Requirements Although a Global Spare drive can be shared by multiple partitions, assigning a separate Global Spare drive to each partition is recommended. If you select to perform a FullScan or a QuickScan using a Global Spare drive, each partition can then perform PostScan operations whenever the prerequisites are met, without waiting for PostScan in another partition to complete.

Refer to the following sections for additional information about using the PreScan and PostScan features:

This section...	Provides...
Assign Global Spare Drives on page 173	Information about configuring a Global Spare drive. A Global Spare drive must be configured for the partition before the FullScan option can be used.
Using PreScan on page 264	Usage requirements for PreScan.
Using PostScan on page 265	Detailed information about how the QuickScan and FullScan options in the PostScan feature operate. This section also provides instructions for manually adding a tape to the PostScan queue and pausing the currently running PostScan process.

PreScan and PostScan System Messages Both PreScan and PostScan generate system messages as possible error conditions are detected (for example, a broken leader or a media error). The messages indicate that the error condition was detected by the PreScan or PostScan process and not during normal operation.

Interaction with Move Requests If a host requests a move while a cartridge is being scanned using one of the partition drives (PreScan or QuickScan), the move is delayed until the scan completes and the cartridge is returned to its slot.

Background Operations To protect you against making changes that could negatively impact the library's operation, the BlueScale software automatically prevents you from performing certain operations while the library is performing background operations, including Media Auto Discovery, PreScan, or PostScan.

- You cannot import or export cartridges while the library is running a Media Auto Discovery or PreScan operation, nor can you use the BlueScale user interface to move cartridges from one location to another in the library.

If you cannot wait for the operation to complete, you can stop Media Auto Discovery or PreScan and then manually start it at another time (see [Stop the Discovery Process on page 264](#)).

- You cannot perform any of the following operations while either a FullScan or a QuickScan that uses Global Spare drives is running in a partition:
 - Import cartridges into or export cartridges from the library
 - Use the BlueScale user interface to move a cartridge from one location to another
 - Use the Global Spare drive being used by PostScan to replace a malfunctioning drive in the partition
 - Change the library configuration settings
 - Create or modify partitions
 - Update BlueScale software or the drive firmware

If you need to perform any of these operations or if you need to reset the library, you can pause the PostScan process for one hour (see [Pause the PostScan Process on page 272](#)). The library returns any cartridges currently being scanned to their original locations. After an hour passes, the library checks the prerequisites for starting PostScan (see [Prerequisites for Starting a PostScan Operation on page 266](#)) and when met, restarts the PostScan operation on the tape that was being verified at the time of the interruption.

Additional MLM Features

In addition to the features described in the previous sections, MLM provides the following features (listed in alphabetical order):

Broadcast Capacity The Broadcast Capacity option changes the capacity displayed on the General Status screen to show broadcast-centric hours of programming used and hours of programming remaining instead of raw capacity (see [Configure How Storage Capacity Displays on page 257](#)).

Database Management Management tools let you manually delete one or more tape records from the MLM database when the tape is retired or permanently exported from the library. You can also download the MLM database as a comma-separated-value (CSV) file and open the file in any software application that supports this type of file (for example, spreadsheet software).

Filled Capacity Information In addition to tracking media health and generating reports, MLM displays a Filled Capacity bar graph on the General Status screen. This graph shows the remaining uncompressed storage capacity for the MLM-enabled media in the entire library or in a specific partition. Click on the Filled Capacity bar graph to view the Media Lifecycle Management Report screen (Figure 143 on page 276).

Note: Until a data cartridge is loaded into, threaded, and then unloaded from a drive for the first time, its data capacity is not included on the Filled Capacity bar graph shown on the General Status screen.

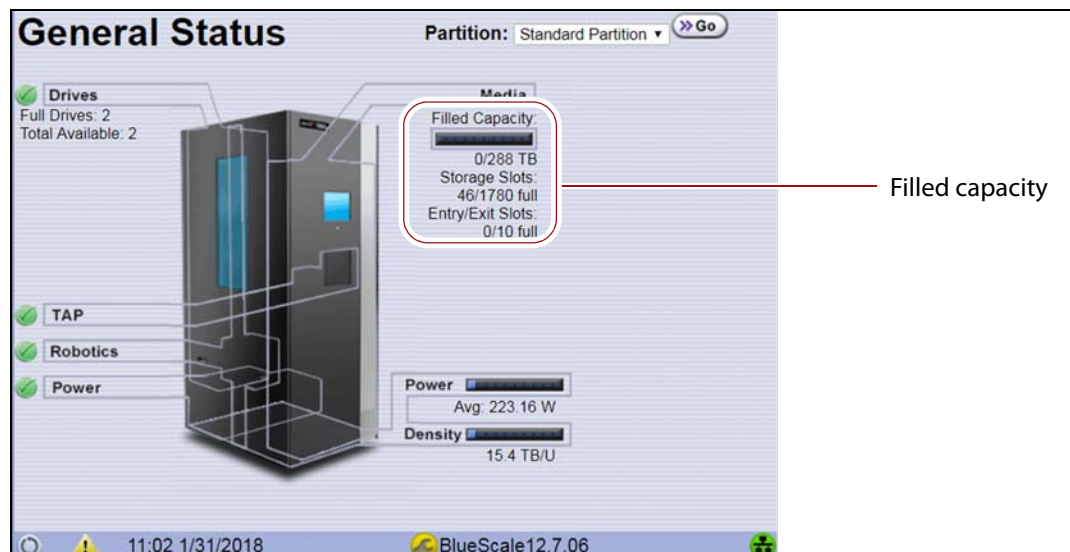

Figure 129 The General Status screen shows the storage capacity usage for the selected partition.

Media Alert The Media Alert feature generates a system message when a tape's health is identified as poor (red) during five consecutive loads. This message is only generated once per tape. A separate system message is generated whenever a cartridge experiences a hard error.

Tracking Non-MLM-Enabled Media MLM tracks the basic health information for data cartridges that are not MLM-enabled. This basic health information is based on tape log data retrieved from an MLM-capable LTO drive when the cartridge is ejected. The data pertinent to media health is stored in the MLM database and used to determine the media health status (Usable or Impaired) included in Media Lifecycle Management reports.

ENABLING MLM AND CONFIGURING GLOBAL SETTINGS

Overview This section describes enabling MLM on the library and configuring the global MLM features. The global features are optional and operate for every partition that is configured to use PreScan and PostScan (see [Enable and Configure MLM PreScan and PostScan on page 178](#)).

- Notes:**
- MLM is enabled by default. If you do not want to use MLM, you must disable it.
 - Disabling MLM also disables DLM.



Important

Before disabling (or re-enabling) Media Lifecycle Management, make sure that none of the drives in the library contain a cartridge. Use your application software to unload cartridges from the drives and return them to the slots in the library.

User Privilege Requirements Only a user with superuser or administrator privileges can enable MLM and configure the global MLM features.

Enable MLM and Configure Settings

Use the following steps to enable MLM and Media Auto Discovery and configure the global settings for MLM. These settings affect all partitions in the library.

Note: Enabling MLM automatically enables Drive Lifecycle Management (DLM) as well. See [Chapter 10 – Using Drive Lifecycle Management, beginning on page 288](#) for information about DLM.

1. Log into the library as a user with superuser or administrator privileges.

- From the toolbar menu, select **Configuration** → **Media Lifecycle Management**. The Media Lifecycle Management Settings screen displays.

Media Lifecycle Management Settings

Enable Media Lifecycle Management

Enable Alerts for Non-MLM Media

Enable Alerts for Load Count Discrepancies

Minimum Cleaning Passes Before Warning: 0

Maximum Tape Loads Before Warning: 10000

Enable Media Auto Discovery

Minimum Idle Minutes Before Auto Discovery: (2-60) 5

Convert to Broadcast Hours: None

Override Broadcast Bit Rate: 0 Mb/sec

PostScan™ Blackout Periods

Specified in hours of the day (to unset day, set both Start and Stop to 0)

Sunday:	Start	0	Stop	0
Monday:	Start	0	Stop	0
Tuesday:	Start	0	Stop	0
Wednesday:	Start	0	Stop	0
Thursday:	Start	0	Stop	0
Friday:	Start	0	Stop	0
Saturday:	Start	0	Stop	0

» Save

Figure 130 Use the Media Lifecycle Management Settings screen to enable MLM and configure the global configuration settings.

3. Select the MLM features you want to use.

Select this option...	To...	Default Setting
Enable Media Lifecycle Management	Enable the Media Lifecycle Management (MLM) features in the library. MLM is enabled by default. Enabling Media Lifecycle Management also enables Drive Lifecycle Management (DLM), which is described in Chapter 10 – Using Drive Lifecycle Management , beginning on page 288.	Selected (Enabled)
Enable Alerts for Non-Certified Media	Configure MLM to generate an alert message when a cartridge that is not MLM-enabled is loaded into a drive. Notes: <ul style="list-style-type: none"> ▪ Enabling this alert is only recommended if all of the media typically used in the library is MLM-enabled. ▪ TS11xx technology cleaning tapes are always treated as MLM-enabled by the BlueScale software. 	Cleared (Disabled)
Enable Alerts for Load Count Discrepancies	Configure MLM to generate an alert message when the load count for the cartridge stored in the MLM database differs from the load count stored on the cartridge's MAM.	Cleared (Disabled)
Minimum Cleaning Passes Before Warning	Set the threshold for the minimum number of cleaning passes remaining on a cleaning cartridge. When an MLM-enabled cleaning cartridge reaches this threshold, a warning message is generated showing that the cleaning cartridge is nearly expired. The warning message is generated every time the cleaning tape is used while the number of cleanings remaining is at or below the threshold value.	Zero (0)
Maximum Tape Loads Before Warning	Set the number of times a tape can be loaded into a drive before a load count warning message is generated. When the number of tape loads reaches the specified threshold, a warning message is generated. Subsequent loads do not generate additional messages. Generate a Load Count Media Lifecycle Report to determine the current usage status of the media in your library (see Using MLM Reporting on page 273 for detailed information). Note: If you began using MLM-enabled cartridges before you enabled MLM, some of your media may already exceed the thresholds you set.	10,000 loads

Select this option...	To...	Default Setting
Enable Media Auto Discovery	<p>Enable the Media Auto Discovery feature.</p> <p>Media Auto Discovery must be enabled before the library proactively discovers newly imported cartridges and adds them to the MLM database.</p> <p>If you enable PreScan for the partition, the Media Auto Discovery process is replaced by the more in depth PreScan process for that partition (see Enable and Configure MLM PreScan and PostScan on page 178).</p> <p>Requirements</p> <ul style="list-style-type: none"> Media Lifecycle Management must be enabled. All cartridges must have barcode labels. <p>Notes:</p> <ul style="list-style-type: none"> The Media Auto Discovery process identifies MLM-enabled cartridges as well as those that are not MLM-enabled. The Media Auto Discovery process may be affected by your storage management software. In addition, software that polls the drives on a regular basis is affected by the discovery process. If you encounter negative interactions with your storage management software, you can choose to either stop the storage management software from accessing the library before starting the discovery process or you can choose not to use Media Auto Discovery. If you do not enable Media Auto Discovery, you can start the discovery process for a specific partition manually. See Discover Cartridges Manually on page 262 for instructions. <p>— OR —</p> <p>You can let the library discover cartridges and add them to the MLM database the first time they are loaded and unloaded from an MLM-enabled drive during normal operations.</p>	Cleared (Disabled)
Minimum Idle Minutes Before Auto Discovery	Set the number of minutes that the library needs to be idle before the Media Auto Discovery process begins.	5 minutes
Convert to Broadcast Hours	Display the MLM capacity using a broadcast-centric method based on hours of content used and total hours of content available instead of raw capacity for all MLM-enabled cartridges. See Configure How Storage Capacity Displays on page 257 for detailed information.	None (Disabled)
PostScan Blackout Periods	Configure time periods during which the automatic PostScan process does not operate. See Configure PostScan Blackout Periods on page 258 for detailed information.	Zero (0) (Disabled)

4. Click **Save** to enable the selected MLM features.

Configure How Storage Capacity Displays

By default, the General Status screen shows the raw storage capacity for all MLM-enabled cartridges in the selected partition. If desired, you can configure the library to use a broadcast-centric method for displaying the storage capacity in terms of hours of content used and total hours of content available.

1. Log into the library as a user with superuser or administrator privileges.
2. From the toolbar menu, select **Configuration** → **Media Lifecycle Management**. The Media Lifecycle Management Settings screen displays (see [Figure 130 on page 254](#)).
3. Select the method for converting to broadcast capacity from the **Convert to Broadcast Hours** drop-down list.

Note: To return to displaying raw capacity, select **None**.



Important

If you select **None** in the **Convert to Broadcast Hours** field, leave the **Override Broadcast Bit Rate** value set to 0.

Media Lifecycle Management Settings

Enable Media Lifecycle Management
 Enable Alerts for Non-MLM Media
 Enable Alerts for Load Count Discrepancies

Minimum Cleaning Passes Before Warning: 0
 Maximum Tape Loads Before Warning: 10000

Enable Media Auto Discovery
 Minimum Idle Minutes Before Auto Discovery: (2-60) 5

Convert to Broadcast Hours: **None** (dropdown menu open showing options: None, DV25, DVCPRO25, MPEG IMX30, MPEG IMX40, MPEG IMX50, DV50, DVCPRO-100, HDTV, DNX120, DNX145, DNX185, DNX220, 2K Resolution Film, DPX, 4K Resolution Film)

Override Broadcast Bit Rate: 0

PostScan™ Blackout Period
 Specified in hours of the day (to unset day, set by 24)

Day	Start	End
Sunday:	Start 0	End 0
Monday:	Start 0	End 0
Tuesday:	Start 0	End 0
Wednesday:	Start 0	End 0
Thursday:	Start 0	End 0
Friday:	Start 0	End 0
Saturday:	Start 0	End 0

Save

Figure 131 Select the conversion settings on the **Convert to Broadcast Hours** drop-down list.

4. The choice that you make in the Broadcast Hours field automatically selects a default **Override Broadcast Bit Rate**. If necessary, change the **Override Broadcast Bit Rate** as required for your environment. The default value for the broadcast bit rate depends on the Broadcast Hours conversion you selected.
5. Click **Save**. The Filled Capacity bar graph on the General Status screen changes to reflect hours of content based on the settings for Convert to Broadcast Hours.

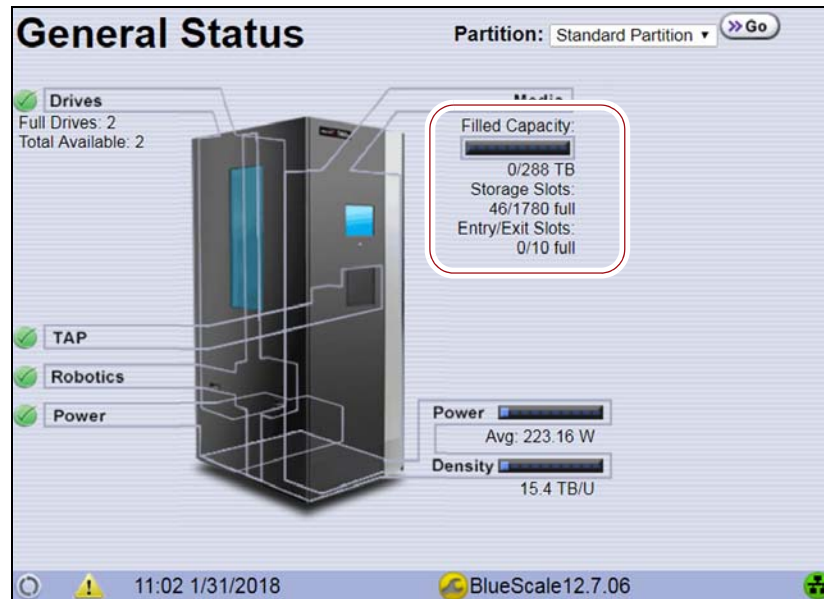

Figure 132 The General Status screen changes to show capacity as Hours of Content.

Configure PostScan Blackout Periods

If desired, you can configure blackout periods during which the automatic PostScan process does not operate. Configuring blackout periods ensures that during your backup window, all of the cartridges in the partition are immediately available and ensures that a Global Spare drive is available if needed.



Important

When configuring blackout periods, keep the following information in mind:

- The blackout periods you configure apply to all of the partitions in the library.
- If PostScan is actively verifying a tape at the time the blackout period starts, it completes the current scan. No additional tapes are scanned until the blackout period expires.

1. Log into the library as a user with superuser or administrator privileges.
2. From the toolbar menu, select **Configuration** ... **Media Lifecycle Management**. The Media Lifecycle Management Settings screen displays.

- In the PostScan Blackout Periods pane, use the **Start** and **Stop** drop-down lists to set the start and end times for the blackout period for each day of the week.

- Notes:**
- Times are based on a 24-hour clock, where 0 is midnight.
 - To disable the blackout period for a specific day, set both **Start** and **Stop** to 0.
 - By default, the blackout periods are all set to 0 (disabled). The PostScan process runs whenever there are tapes in the PostScan queue and a Global Spare drive is available.

Media Lifecycle Management Settings

Enable Media Lifecycle Management
 Enable Alerts for Non-MLM Media
 Enable Alerts for Load Count Discrepancies
 Minimum Cleaning Passes Before Warning:
 Maximum Tape Loads Before Warning:

Enable Media Auto Discovery
 Minimum Idle Minutes Before Auto Discovery: (2-60)

Convert to Broadcast Hours: ▾
 Override Broadcast Bit Rate: Mb/sec

PostScan™ Blackout Periods
 Specified in hours of the day (to unset day, set both Start and Stop to 0)

Sunday:	Start	<input type="text" value="0"/> ▾	Stop	<input type="text" value="0"/> ▾
Monday:	Start	<input type="text" value="0"/> ▾	Stop	<input type="text" value="0"/> ▾
Tuesday:	Start	<input type="text" value="0"/> ▾	Stop	<input type="text" value="0"/> ▾
Wednesday:	Start	<input type="text" value="0"/> ▾	Stop	<input type="text" value="0"/> ▾
Thursday:	Start	<input type="text" value="0"/> ▾	Stop	<input type="text" value="0"/> ▾
Friday:	Start	<input type="text" value="0"/> ▾	Stop	<input type="text" value="0"/> ▾
Saturday:	Start	<input type="text" value="0"/> ▾	Stop	<input type="text" value="0"/> ▾

Figure 133 Select the desired blackout periods for PostScan.

- Click **Save**.
- The blackout periods you set take effect when you enable PostScan for individual partitions by configuring one or more PostScan triggers (see [Enable and Configure MLM PreScan and PostScan on page 178](#)).

USING MEDIA LIFECYCLE MANAGEMENT

Overview After you enable MLM and configure the global settings (see [Enabling MLM and Configuring Global Settings on page 253](#)), you are ready to begin using MLM to track and monitor the media in the library.

Note: If you want to use the PreScan and PostScan options, you must enable and configure these options for each partition (see [Enable and Configure MLM PreScan and PostScan on page 178](#)).

User Privilege Requirements See [Specify the Partition Users on page 184](#) for information about assigning users to a partition.

- Only a user with superuser or administrator privileges can manually start and stop media discovery (using either Media Auto Discovery or PreScan), manually start and pause PostScan operations, and manage the MLM and DLM databases.
- Any user with operator privileges who is assigned to the partition and all users with superuser or administrator privileges can generate and save MLM reports.

Add Cartridges to the MLM Database

The cartridges used in the library are not added to the MLM database until they are discovered. The process you use to discover cartridges and add them to the MLM database depends on when you loaded the cartridges into the library.





Important

If a cartridge is write-protected when it is inserted into a drive, the library cannot update the MLM information on the cartridge's MAM.

- Notes:**
- Media Auto Discovery cannot begin while the library is actively loading media into drives. If you import media during this time, the library posts a failure message stating that no drives are available. Either wait until the library is idle before importing media or start the discovery process for imported media manually when the library is idle.
 - If you import cartridges into the library with MLM disabled, those cartridges are not automatically discovered and added to the MLM database. After you enable MLM, you must use the manual discovery process to add the cartridges to the MLM database (see [Discover Cartridges Manually on page 262](#)).

The following table provides information about different possible scenarios for adding cartridges to the MLM database.

If you...	Do this to add the cartridges to the MLM database...
<p>Recently purchased your library and are importing cartridges into the library for the first time,</p>	<ol style="list-style-type: none"> 1. Make sure that MLM is enabled (see Enabling MLM and Configuring Global Settings on page 253). 2. If desired, enable PreScan (see Using PreScan on page 264). 3. Import media into the partitions to trigger the automatic discovery process. <p> Important: Discovery cannot begin while the hosts are actively loading cartridges into and unloading cartridges from drives. If you import cartridges during this time, the library posts a failure message stating that no drives are available. Either wait until the library is idle before importing cartridges or manually start the discovery process when the library is idle.</p>
<p>Have an existing library with the most current BlueScale version installed. Cartridges are already imported into the library, but you just recently enabled MLM,</p>	<ol style="list-style-type: none"> 1. If you want to detect any non-MLM-enabled cartridges being imported, temporarily enable the alert on the Media Lifecycle Management Settings screen (see Enable Alerts for Non-Certified Media on page 255). The alert is disabled by default. 2. If desired, enable PreScan (see Using PreScan on page 264). 3. Discover the cartridges in the library using one of the following methods: <ul style="list-style-type: none"> ▪ Import new cartridges into the partition to trigger the automatic discovery process. If you do not have PreScan enabled, the discovery process only checks cartridges that are not already in the MLM database. If PreScan is enabled, all of the cartridges in the partition are processed, regardless of whether or not they are already in the MLM database. <p> Important: Discovery cannot begin while the hosts are actively loading cartridges into and unloading cartridges from drives. If you import cartridges during this time, the library posts a failure message stating that no drives are available. Either wait until the library is idle before importing cartridges or manually start the discovery process when the library is idle.</p> <ul style="list-style-type: none"> ▪ If you do not want to wait until you import new cartridges to have the cartridges already in the library added to the MLM database, manually start the discovery process (see Discover Cartridges Manually). ▪ Use your storage management software to load each cartridge into an drive and then unload it. ▪ Let the library update the MLM database as part of normal operation. The information for each cartridge is added to the MLM database the first time the cartridge is loaded into and then unloaded from a drive. <ol style="list-style-type: none"> 4. When the initial discovery process is complete, disable the alert about non-MLM-enabled media, if desired. 5. To routinely verify the readability of the cartridges, configure PostScan for each partition in the library (see Using PostScan on page 265).

Discover Cartridges Manually

1. Make sure that Media Lifecycle Management is enabled before you start the discovery process (see [Enabling MLM and Configuring Global Settings](#) on page 253).
2. From the toolbar menu, select **Maintenance ... Media Lifecycle Management**. The Media Lifecycle Management Tools screen displays.
3. Click **Discover Media** to start the manual discovery process.

Note: If all of the media in the library was previously discovered, the **Discover Media** button is grayed out. You do not need to perform a manual media discovery.

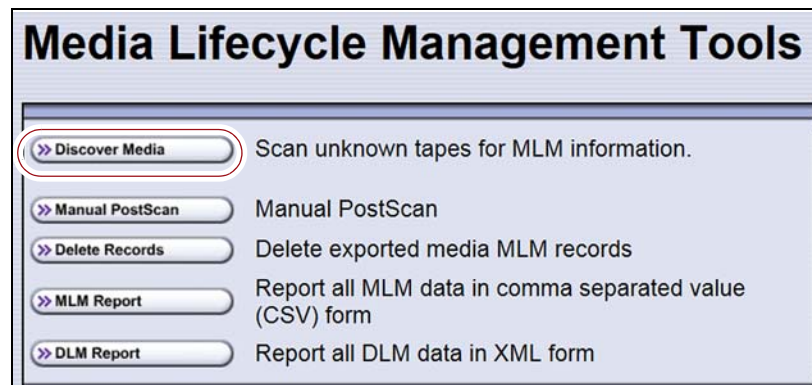

Figure 134 Click **Discover Media** on the MLM Tools screen to begin configuring a manual media discovery process.

4. Select the partition containing the cartridges you want to add to the MLM database, then click **Next**.

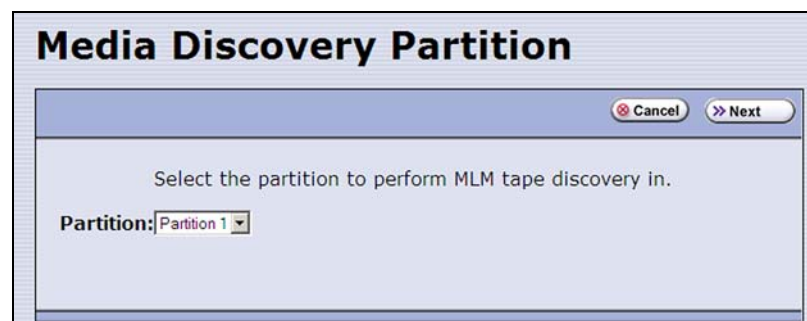

Figure 135 Select the partition containing the cartridges you want to add to the MLM database.

5. Click **OK** on the Start Media Discovery screen to begin the discovery process.

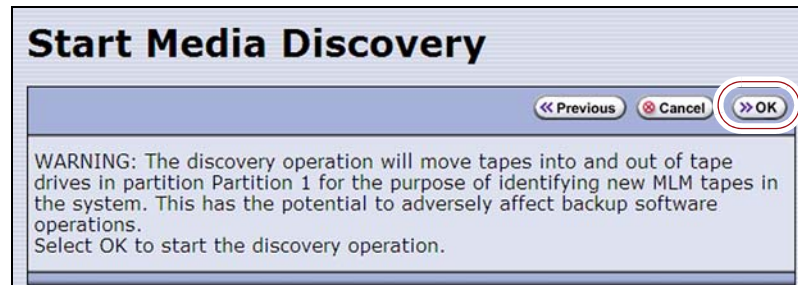

Figure 136 Click **OK** on Start Media Discovery screen to start media discovery.

6. When the Media Discovery Start Results screen displays, click **OK** to confirm that the process started and return to the Media Lifecycle Management Tools screen.

The discovery process continues in the background while the library continues to operate.

Note: See [Background Operations on page 251](#) for information about operations that cannot be performed while the discovery process is running.



Figure 137 The Media Discovery Start Results screen displays when the discovery process starts.

Stop the Discovery Process

If for some reason you need to interrupt the discovery process before it is complete, click **Stop Discovery** on the Media Lifecycle Management Tools screen. The library completes any Media Auto Discovery or PreScan operations that are in progress and returns the cartridges to their slots.



Figure 138 Click **Stop Discovery** to stop the discovery process.

To resume the discovery process, repeat the steps in [Discover Cartridges Manually on page 262](#) or wait until you import additional cartridges into the partition to trigger the discovery process automatically.

USING PRESCAN

Overview The MLM PreScan feature is a background process that replaces the default Media Auto Discovery process in partitions where it is enabled; unlike Media Auto Discovery it does not operate globally. PreScan is enabled when you configure the partition (see [Enable and Configure MLM PreScan and PostScan on page 178](#)).

PreScan provides verification of data cartridges by performing a basic functionality test and health check on each imported cartridge. As a part of the PreScan process, any cartridges that are not already in the MLM database are added to the MLM database.

During the PreScan process, the library automatically inserts each cartridge into a drive assigned to the partition. The drive loads the cartridge and checks it to determine whether it has any of the following characteristics:

- Non-MLM-enabled
- Broken or dislodged leader
- Red media health
- Write protected
- Encrypted tape with a moniker not currently stored in the library

When the PreScan process completes, the library stores the tape health information for the cartridge in the MLM database. It also writes the MLM data to the cartridge MAM. When the drive ejects the cartridge, the library returns it to its original slot.

Requirements for Use When using PreScan, make sure that you consider the following requirements:

Consideration	Requirement
Updating MLM Data on MAM	Updating the cartridge MAM requires the cartridge to be write-enabled.  Important: If a cartridge is write-protected when it is inserted into a drive, the information about the cartridge is added to the MLM database, but the library cannot update the MLM information on the cartridge's MAM.
Drive Availability	The media discovery process loads the cartridges in the partition into the drives assigned to that partition. While in use for PreScan, host moves to the drives being used are delayed until the PreScan operation completes. Spectra Logic highly recommends that you perform the manual media discovery process when your storage management software is not accessing the library and the library is idle.
Auto Drive Clean Restrictions	Auto drive clean operations do not start while PreScan is running on any partition that is associated with the cleaning partition. If a drive requires cleaning, wait until the PreScan operation is complete and then manually clean the drive.
Cleaning Partitions	The PreScan feature cannot be enabled for a cleaning partition and does not affect the operation of cleaning cartridges.

USING POSTSCAN

This section provides detailed information about how PostScan operates, as well as prerequisites for using PostScan and performing manual PostScan operations.



Important

PostScan is enabled and configured for each individual partition. PostScan does not operate until the PostScan option is selected and one or more triggers are specified for the partition (see [Enable and Configure MLM PreScan and PostScan on page 178](#)).

Note: PostScan cannot be configured for use in the same partition as Spectra SKLM or KMIP encryption key management.

Operational Overview

PostScan — either FullScan or QuickScan — performs a readability verification test to verify data integrity for all of the cartridges in the MLM database. FullScan uses a Global Spare drive assigned to the partition and QuickScan uses a drive in the partition or Global Spare drive assigned to the partition to check each cartridge in the partition for media errors that can impact the ability to restore the data.

The PostScan process is performed by the library independent of the storage management software normally used to read and write data to the tape. You can choose to perform PostScan either automatically or manually. For automatic scans you can set the scanning frequency and select options to determine the type of scan performed.

Using FullScan on tapes that are written using variable-length block sizes is not recommended.

Prerequisites for Starting a PostScan Operation

When an MLM-enabled cartridge meets the PostScan trigger criteria configured for the partition, the cartridge is added to the PostScan queue. The queue is processed in a first-in-first-out (FIFO) basis.

Note: The automatic PostScan triggers only apply to MLM-enabled cartridges. Cartridges that are not MLM-enabled must be manually added to the PostScan queue (see [Request a Manual PostScan on page 270](#)).

Before beginning the PostScan process, the library verifies that the following prerequisites are met:

- The system is idle for the period of time specified for the partition (see [Enable and Configure MLM PreScan and PostScan on page 178](#)).
- The library is not currently in a PostScan blackout period (see [Configure PostScan Blackout Periods on page 258](#)).
- If **Full Scan** is enabled, a Global Spare drive assigned to the partition is available.

— OR —

If **QuickScan** is enabled, a drive in the same partition as the cartridge that met the PostScan trigger criteria is available.

— OR —

If **QuickScan with Spare Drives** is enabled, a Global Spare drive assigned to the partition is available.

Cartridge Scanning

If the PostScan prerequisites are met, the library inserts the first cartridge in the PostScan queue into an available drive. The cartridges in the PostScan queue are processed on a first-in-first-out (FIFO) basis. Depending on the PostScan option selected for the partition, the drive loads the cartridge and begins one of the following operations to check for media errors.

- Notes:**
- PostScan reads the data on the tape but does not process this data into a usable form. It simply verifies that it can read the data from the tape.
 - See [Enable and Configure MLM PreScan and PostScan on page 178](#) for additional information about the differences between the FullScan and QuickScan processes.

This PostScan option...	Uses...
FullScan	<p>A Global Spare drive assigned to the partition. FullScan verifies all of the data on the tape, from the beginning of the tape (BOT) to the end of the recorded data (EOD) or the physical end of the tape, whichever comes first.</p> <p>Notes:</p> <ul style="list-style-type: none"> ▪ A Global Spare drive must be assigned to the partition. ▪ Partitions using SAS drives cannot use FullScan. ▪ The cartridge does not appear on the BlueScale inventory screens while it is being scanned. If the cartridge is requested by the storage management software it is immediately ejected from the drive that is performing the verification and moved to the location requested by the storage management software. A system message is posted to indicate that the FullScan operation was interrupted. The cartridge is returned to the top of the PostScan queue and is the first one processed after it is returned to its slot. ▪ The Global Spare drive cannot be activated while FullScan is running. You must first pause the PostScan process (see Pause the PostScan Process on page 272). The library immediately aborts the FullScan currently in progress and returns the cartridge to its original location. You can then activate the Global Spare drive (see Using a Global Spare Drive on page 352). The aborted FullScan process resumes when the Global Spare drive is again available. ▪ The time to complete a FullScan depends on the type and amount of data on the tape and whether it was written using fixed- or variable-length blocks. ▪ Using FullScan on tapes that are written using variable-length block sizes is not recommended.

This PostScan option...	Uses...
QuickScan	<p>One of the drives in the partition. QuickScan verifies all of the data on a single wrap, from the beginning of the tape (BOT) to the end of the wrap or the end of recorded data (EOD), whichever comes first.</p> <p>Notes:</p> <ul style="list-style-type: none"> ▪ If a Global Spare drive is not assigned to the partition, a QuickScan using one of the partition's drives is the only option available. ▪ If possible, the library avoids using the drive in which the cartridge was most recently unloaded to perform the QuickScan. ▪ A QuickScan using a partition's drive is limited to three minutes. If the QuickScan exceeds this time limit, the operation is aborted and the cartridge is returned to its slot. The library posts a message stating that the QuickScan failed. Use FullScan to verify the cartridge. ▪ While QuickScan is running, all moves in the partition are delayed until the scan is complete.
QuickScan using a Global Spare	<p>A Global Spare drive. QuickScan verifies all of the data on a single wrap, from the beginning of the tape (BOT) to the end of the wrap or the end of recorded data (EOD), whichever comes first.</p> <p>Notes:</p> <ul style="list-style-type: none"> ▪ A Global Spare drive must be assigned to the partition. ▪ Partitions using SAS drives cannot use QuickScan using a Global Spare drive. ▪ The cartridge does not appear on the BlueScale inventory screens while it is being scanned. If the cartridge is requested by the storage management software it is immediately ejected from the drive that is performing the verification and moved to the location requested by the storage management software. A system message is posted to indicate that the QuickScan operation was interrupted. The cartridge is returned to the top of the PostScan queue and is the first one processed after it is returned to its slot. ▪ The Global Spare drive cannot be activated while a QuickScan using Global Spares is running. You must first pause the PostScan process (see Pause the PostScan Process on page 272). The library immediately aborts the QuickScan currently in progress and returns the cartridge to its original location. You can then activate the Global Spare drive (see Using a Global Spare Drive on page 352). The aborted QuickScan process resumes when the Global Spare drive is again available. ▪ A QuickScan using a Global Spare drive is limited to 10 minutes. If the QuickScan exceeds this time limit, the operation is aborted and the cartridge is returned to its slot. The library posts a message stating that the QuickScan failed. Use FullScan to verify the cartridge.

Updating the MLM Database

When the PostScan process on a cartridge is complete, the library writes the scan date and a pass/fail test result to the cartridge MAM and updates the MLM database with the scan date, the pass/fail test result, and when (or if) the next scan should occur. The drive then unloads the cartridge and the library returns it to its original slot. The library then posts a system message showing that the cartridge was scanned. If the QuickScan used a partition drive, the library reports that the unload move for the backup operation that preceded the QuickScan is complete.

Global Spare Drive Cleaning

After a cartridge is unloaded from a Global Spare drive following a PostScan verification, the library checks to see if the drive requires cleaning. If cleaning is required and a cleaning partition is associated with the storage partition to which the Global Spare is assigned, the drive is cleaned before the next cartridge is processed.

Note: If a cleaning partition is not present, periodically check the Drive Details screen for each drive to determine whether cleaning is required. If cleaning is required, follow the instructions provided in [Manually Cleaning a Drive on page 416](#).

Address Requirements for Use

As you configure and use PostScan, keep the following in mind:

Consideration	Description
Updating MLM Data on MAM	Updating the cartridge MAM requires the cartridge to be write-enabled.  Important: If a cartridge is write-protected when it is inserted into a drive, the information about the cartridge is added to the MLM database, but the library cannot update the MLM information on the cartridge's MAM.
Drive Support for PostScan	<ul style="list-style-type: none"> FullScan, QuickScan, and QuickScan using Global Spare are available for all Fibre Channel LTO and TS11xx technology drives. Partitions using SAS drives cannot use FullScan or QuickScan using a Global Spare drive. <p>Note: While a drive is in use for QuickScan operations, it is unavailable to the storage management software.</p>
Background Operations	To protect you from making changes that could negatively impact the library's operation, the BlueScale software automatically prevents you from performing certain operations while either a FullScan or a QuickScan that uses Global Spare drives is running. However, you can pause the FullScan or QuickScan operation if you cannot wait for it to complete. See Background Operations on page 251 for detailed information.

Consideration	Description
Storage Management Software Configuration	When using automatic PostScan to check your cartridges, configure your storage management software to allow at least 15 minutes for a requested move to complete. If a cartridge is in the process of being scanned when it is requested for a backup or restore operation, it must be unloaded from the Global spare and moved to another drive before the move request is reported as complete.
Global Spare Drives	Both FullScan and QuickScan using Global Spare require a Global Spare drive. Although a Global Spare drive can be shared by multiple partitions, assigning a separate Global Spare drive to each partition is recommended. Each partition can then perform PostScan whenever the prerequisites are met, without waiting for PostScan in another partition to complete.
Blackout Periods	Because the storage management software can potentially request a tape that is currently undergoing verification, you can configure blackout periods during which the PostScan operation is suspended. Configuring blackout periods ensures that PostScan does not operate during your normal backup window. The blackout periods apply to all of the storage partitions in the library. See Configure PostScan Blackout Periods on page 258 for instructions.
Cleaning Partitions	The PostScan feature cannot be enabled for a cleaning partition and does not affect cleaning tapes.

Enable PostScan

PostScan is enabled by selecting one or more trigger criteria when you configure a partition (see [Enable and Configure MLM PreScan and PostScan on page 178](#)). The available PostScan options depend on the drive type and whether or not a Global Spare drive is assigned to the partition.



Important

PostScan is enabled and configured for each individual partition. PostScan does not operate until the PostScan option is selected and one or more triggers are specified for the partition.

Request a Manual PostScan

The automatic PostScan triggers only add MLM-enabled data cartridges to the PostScan queue. However, cartridges can also be added to the PostScan queue manually. This is especially useful if your library contains cartridges that are not MLM-enabled. You can also use the manual PostScan process to verify a suspect MLM-enabled cartridge even if it was previously scanned.

Cartridges that are manually added to the PostScan queue are processed before cartridges that were added as a result of the trigger criteria for the partition. They are processed using the PostScan option that was specified for the partition.

Use the following steps to manually start the PostScan process.

1. Enable Media Lifecycle Management if it is not already enabled (see [Enabling MLM and Configuring Global Settings](#) on page 253).
2. From the toolbar menu, select **Maintenance ... Media Lifecycle Management**. The Media Lifecycle Management Tools screen displays.

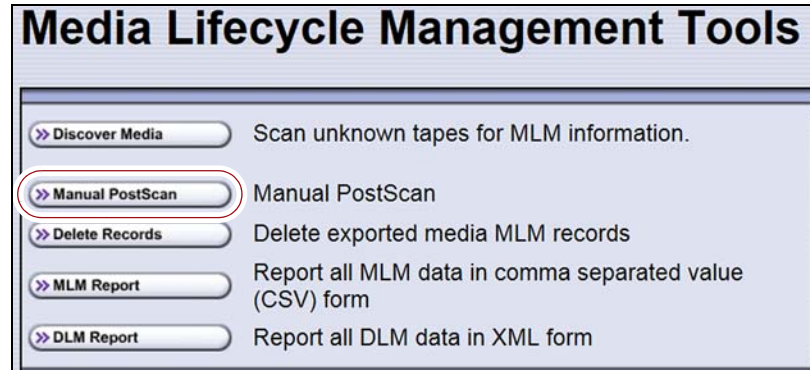

Figure 139 Click **Manual PostScan** on the MLM Tools screen.

3. Click **Manual PostScan**. The MLM Manual PostScan screen displays showing the information for the partition that was selected the last time the screen was viewed.

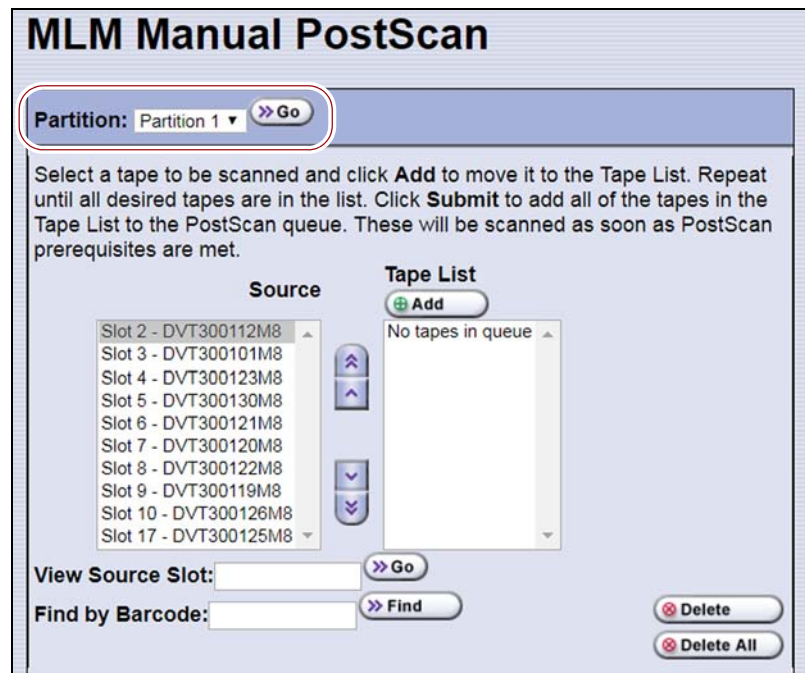



Figure 140 The MLM PostScan screen.

4. If the media is in a partition other than the one currently displayed, select the desired partition from the **Partition** drop-down list, then click **Go**.

The **Source** list refreshes to display a list of the cartridges in the requested partition. The list shows the name of the location (for example, the slot number) and the barcode label information for the cartridge in that location.

5. Select the cartridge that you want to check for media errors. You can select the cartridge either from the **Source** list, by entering its barcode, or by entering the slot number where it is located.

To select a cartridge using the...	Follow these steps...
Source list	Scroll through the list of available media and select the desired cartridge.
Slot number	<ol style="list-style-type: none"> 1. Enter the slot number for the cartridge you want in the View Source Slot field. 2. Click Go. The Source list refreshes to show the requested cartridge highlighted at the top of the list. 3. Click the cartridge to select it.
Barcode label information	<ol style="list-style-type: none"> 1. Enter the barcode label information for the cartridge you want to locate in the Find by Barcode field. 2. Click Find. The Source list refreshes to show the requested cartridge highlighted at the top of the list. 3. Click the cartridge to select it. <p> Important: Only the slots below the top one displayed in the list are searched. Scroll to the top of the source list before clicking Find. The search starts at the second visible slot.</p>

6. Click **Add** to add the selected cartridge to the **Tape List**.
7. Repeat [Step 4](#) through [Step 6](#) to add additional tapes to the **Tape List**.

Note: If you want to remove one or more cartridges from the **Tape List**:

 - Select the cartridge and click **Delete** to remove it from the list.
 - Click **Delete All** to remove all of the cartridges from the list.
8. Click **Submit** to add the cartridges in the **Tape List** to the PostScan queue.

Pause the PostScan Process

If you need to perform any of the operations listed in [Background Operations on page 251](#) or if you need to reset the library, you can pause the PostScan process. The library returns any cartridges currently being scanned to their original locations.



Important Pausing PostScan affects all partitions that are configured to use PostScan.

Use the following steps if you need to temporarily pause the PostScan process.

1. From the toolbar menu, select **Maintenance**  **Media Lifecycle Management**. The Media Lifecycle Management Tools screen displays.

Note: The **Pause PostScan** button is only present if the PostScan process is running.

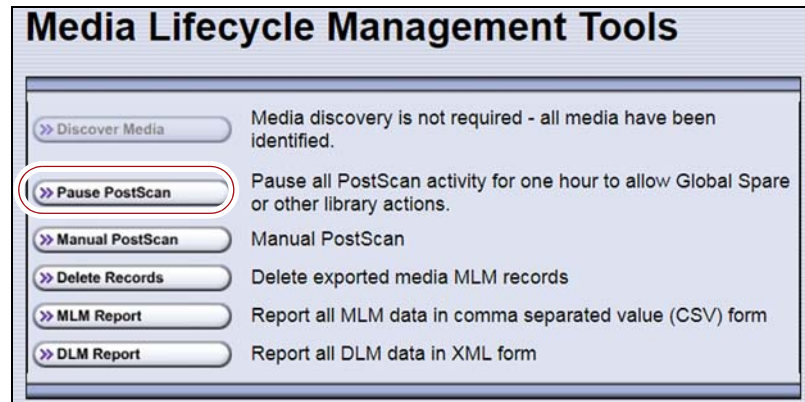

Figure 141 Click **Pause PostScan** on the MLM Tools screen to interrupt the PostScan process.

2. Click **Pause PostScan** to pause the PostScan operation for one hour so that you can use the Global Spare or perform other library operations. After an hour passes, the library restarts the PostScan operation on the tape that was being verified at the time of the interruption, provided the PostScan prerequisites listed on [page 266](#) are met.

USING MLM REPORTING

After the LTO cartridges in your library are added to the MLM database, you are ready to make use of this powerful tool to manage, track, and report all facets of tape usage from creation to retirement.

Generate MLM Reports

1. Log into the library.
2. From the toolbar menu, select **General**  **Media Lifecycle Management**. The Media Lifecycle Management Report screen displays.

Note: You can also click on the Filled Capacity bar graph on the General Status screen ([Figure 129 on page 252](#)).

3. Select either **Total Library** or a specific partition from the **Partition** drop-down list, and then click **Go**.

Note: By default, the Media Lifecycle Management Report screen shows a Media Health report for all Spectra Certified MLM-enabled cartridges in the entire library.

Barcode	Media Health	Load Count
000084L5	Usable	Non-Cert
000072L5	Poor	6764
000074L5	Average	4886
000151L5*	Average	2916
000134L5	Good	2385
241844L4	Good	2800
000294L5	Good	1639

= Spectra Certified Media
 = CarbideClean™ Media

>> Save Report Find by Barcode: >> Find

Figure 142 Select the partition for which you want to display the media health report.

4. Select the type of report you want from the **Report** drop-down list.

Note: Information about MLM-enabled cleaning cartridges only appears in the Exported Media, Cleans Remaining, and Born on Date reports.

This report...	Shows...
Media Health	<ul style="list-style-type: none"> ▪ The barcode label information, the overall health (media health), and the load count (the number of times the cartridge was loaded into a drive) for each MLM-enabled cartridges in the selected location. ▪ The barcode label information for each non-MLM-enabled cartridge and whether the cartridge appears to be usable or impaired.
Remaining Capacity	<p>The remaining capacity and maximum capacity for each MLM-enabled data cartridge. The capacity reflects the native capacity of the cartridge, not the compressed capacity.</p> <p>Notes:</p> <ul style="list-style-type: none"> ▪ Until a data cartridge is loaded into, threaded, and then unloaded from a drive for the first time, its remaining capacity and maximum capacity report as “0”. ▪ The remaining capacity and maximum capacity for a cartridge are displayed as GB or TB. ▪ This report is not available for non-MLM-enabled cartridges.
Load Count	<p>The load count for each MLM-enabled data cartridge in the selected location and the born on date (the date on which Spectra Logic enabled the cartridge to support MLM tracking and reporting).</p> <p>Note: This report is not available for non-MLM-enabled cartridges.</p>
Write Errors	<p>The number of soft errors and the load count for each MLM-enabled data cartridge.</p> <p>Note: This report is not available for non-MLM-enabled cartridges.</p>
Cleans Remaining	<p>The number of cleansings remaining and the born on date for each MLM-enabled cleaning cartridges.</p> <p>Note: This report is not available for non-MLM-enabled cartridges.</p>
Born on Date	<p>The date that the MLM-enabled cartridge (both data and cleaning) was created and certified by Spectra Logic and the load count for each cartridge.</p> <p>Note: This report is not available for non-MLM-enabled cartridges.</p>
Exported Media	<p>A list of all the MLM-enabled cartridges (both data and cleaning) that were exported from the library, sorted by the export time (oldest first). The report also shows the user name of the person who exported the media.</p> <p>Note: This report is not available for non-MLM-enabled cartridges.</p>
Last Write Time Last Read Time	<p>Shows the time and date for the most recent write and read operations for each MLM-enabled data cartridge.</p> <p>Note: This report is not available for non-MLM-enabled cartridges.</p>

- Click **Go**. The Media Lifecycle Management Report screen refreshes to display the selected report with a list of the barcode labels for all media in the selected location. A media health icon indicates the overall health of each MLM-enabled cartridge as of the last time it was loaded into a drive.

Note: Health icons are not used with media that is not MLM-enabled Spectra Certified media.

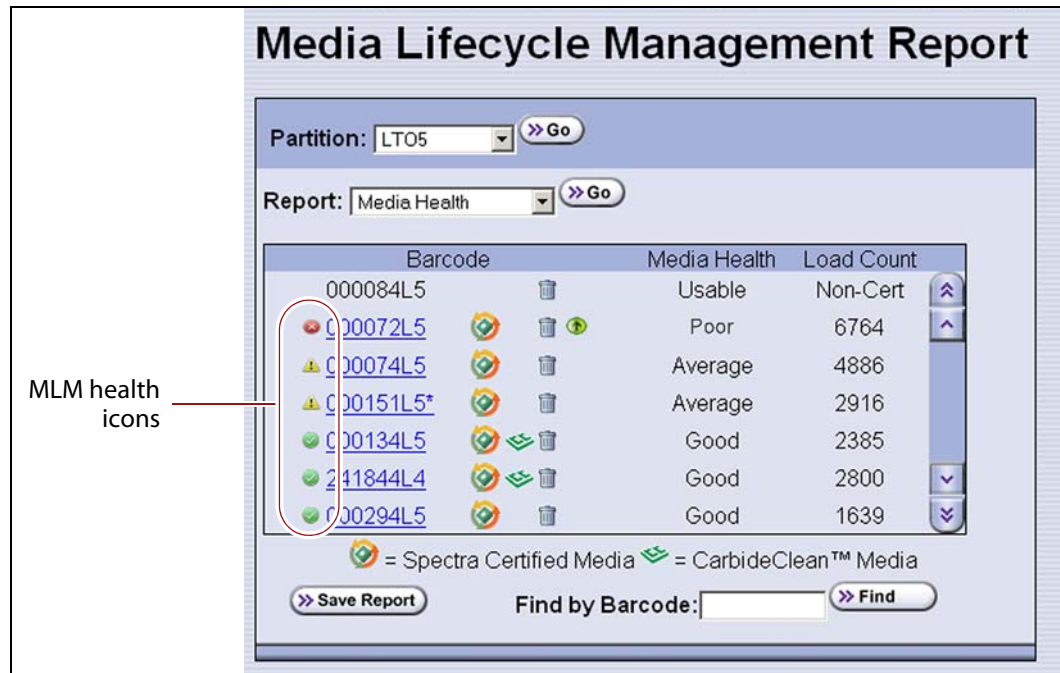







Figure 143 Use the health icons on the Media Lifecycle Management Report screen to quickly assess media health.

The following table describes the meaning of each media health icon. Select the barcode next to the icon to view detailed information about that specific piece of media.

Icon	Health score	Meaning
	100 – 80	The media health is Good . <ul style="list-style-type: none"> ▪ Data cartridge: The media is in good condition and operating properly. The cartridge can be used for writing new data and reading previously written data. ▪ Cleaning cartridge: More than 10 cleaning cycles remain on the cartridge.
	79 – 50	The media health is Average . <ul style="list-style-type: none"> ▪ Data cartridge: When the Health graph on the Details screen for the cartridge falls below a health score of 80, the media health icon changes from green to yellow (generally due to normal aging). For maximum reliability, only use the cartridge for restores. ▪ Cleaning cartridge: The cleaning cartridge is near expiration. From one to ten cleaning cycles remain.

Icon	Health score	Meaning
	49 – 0	<p>The media health is Poor.</p> <ul style="list-style-type: none"> ▪ Data cartridge: When the Health graph on the Details screen for the cartridge falls below a health score of 50, the media health icon changes to red. The combination of media errors, tape age, and usage indicates that the media reached the end of its useful life for reliable data backups and restores and should be retired. <p>If you are experiencing an unexpected number of cartridges with poor media health, you may want to investigate further:</p> <ul style="list-style-type: none"> ▪ Review the media health data for each cartridge to see if it has a high error rate. A high error rate can indicate either that the media health is poor and the cartridge should be retired or that the cartridge was written to by a drive that is having trouble. ▪ If multiple cartridges with high error rates were written to by the same drive, the drive may be the source of the errors. Clean the drive or, if necessary, replace it. <p>Notes:</p> <ul style="list-style-type: none"> ▪ If the source of the high error rate is a drive, the media health icon for the affected cartridges should return to either green or yellow after approximately three load/read or write/unload cycles in a known good drive. ▪ If your cartridge has a high error rate that cannot be attributed to a faulty drive, environmental factors, or the end of the cartridge's normal working life, contact Spectra Logic Technical Support for troubleshooting assistance (see Contacting Spectra Logic on page 7). ▪ Cleaning cartridge: The cleaning cartridge is expired. No more cleaning cycles remain. Replace the cleaning cartridge.
		The media health is Unknown . The status of the media cannot be determined.

6. If you want to view detailed information about a specific cartridge, use one of the following methods to locate the cartridge.

To find a cartridge using the...	Follow these steps...
Cartridge list	Scroll through the list of cartridges on the Media Lifecycle Management Report screen to locate the desired cartridge.
Barcode label information	<ol style="list-style-type: none"> 1. Enter the barcode label information for the cartridge you want to locate in the Find by Barcode field. 2. Click Find. The list of cartridges refreshes to show the requested cartridge highlighted at the top of the list. <p> Important: Only the slots below the top one displayed in the list are searched. Scroll to the top of the source list before clicking Find. The search starts at the second visible slot.</p>

- Click the barcode in the Media Lifecycle Management Report screen to view detailed information about the cartridge. The Details screen for the selected cartridge displays.

Media health is based on the MLM-tracked history of the cartridge. The health indicated by the Health graph on the Details screen may fluctuate until the cartridge is loaded six times.

When using CarbideClean media, the Details screen includes additional information related to the CarbideClean process. This information is not present for MLM media that was not put through the CarbideClean process.

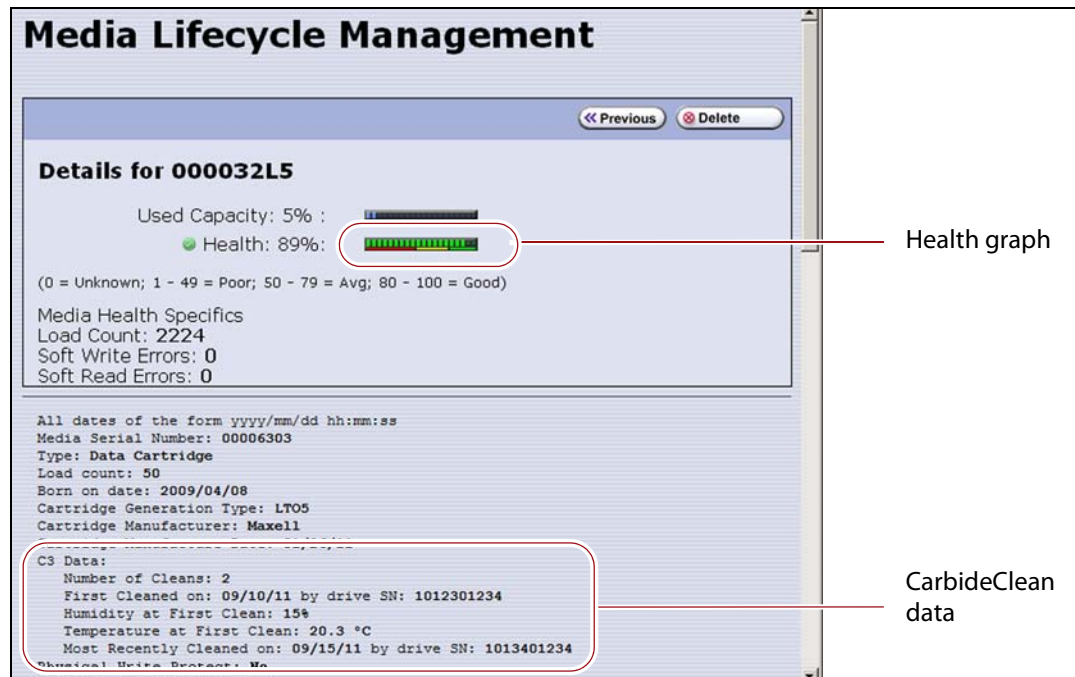

Figure 144 The detailed MLM report for the selected media.

- Click **Previous** to return to the main Media Lifecycle Management Report screen (Figure 143 on page 276).

Save an MLM Report

You can choose to save a copy of the MLM report, which is a comma-separated text file (*.rpt), to a USB device, mail the saved report to previously configured email recipient, or both. If desired, you can zip the file before saving it.

Note: You can also download the MLM database as a comma-separated-value (CSV) file (see [Download the MLM Database for Analysis and Archival](#) on page 287).

- Generate the desired report as described in [Generate MLM Reports](#) on page 273.

- If you want to save the MLM report to a USB device, connect the device to a USB port on the LCM or operator panel and allow time for the device to mount before continuing.

Note: The option to save the report to a USB device is only available if you connect a USB device to the library before you click **Save Report** on the Media Lifecycle Management Report screen.

- Click **Save Report** to display the Save Media Lifecycle Management Report screen.

Figure 145 Select the desired options on the Save Media Lifecycle Management Report screen.

- Select the data to include in the saved report and how you want the report saved.

Note: If you want to email the report, the intended recipient must be a previously configured mail user (see [Configure Mail Users on page 106](#)).

This option...	Saves...
Report All Media Lifecycle Data	A report containing all of the available detailed MLM data for MLM-enabled media in the selected location (a specific partition or the total library). Note: Depending on the number of cartridges in the selected location, this report can be quite large.
Report Selected Data	Only the fields displayed in the report that you selected on the Media Lifecycle Management Report screen (Figure 143 on page 276). Note: The headings in the saved report reflect the fields displayed in the report you selected in the Media Lifecycle Management Report screen.
Zip Report	The report as a zip file. Zipping the report is especially useful when emailing the Report All Media Lifecycle Data report. Note: If you unzip the report using the standard format used by most file-zipping applications, the application creates the following directory structure: *\hard disk\lc\reports.

This option...	Saves...
Mail Report to	The report and attaches it to an email sent to a previously configured mail user. Use the drop-down list to select the recipient for the report file. Note: Do not use the default <i>autosupport@spectralogic.com</i> email user. Spectra Logic does not save emailed MLM report files unless they are specifically requested for troubleshooting.
Save to USB	Save the report to the USB device. Note: The USB option is only available if you connected a USB device to the library before you clicked Save Report on the Media Lifecycle Management Report screen.

- Click **Save** to send the report to the selected destination. Click **Previous** to return to the Media Lifecycle Management Report screen without sending the report.

Override a Poor Cartridge Health Report

Under certain circumstances you may need to override the health of an MLM-enabled cartridge that is reported as poor (a red health icon appears next to the cartridge barcode). When the cartridge health is poor, a green arrow button, that can be used to override the reported health, displays.

During the override process, the library progressively eliminates any recent hard errors from the tape health calculation. If the health is still red, all hard errors are eliminated from the tape health calculation. The library continues to use this adjusted tape health until the cartridge health returns to either Good or Average as part of the normal health monitoring.



Important

Do not reset the cartridge health unless you believe that the reported poor health is due to drive problems and not the cartridge or you are specifically directed to do so by Spectra Logic Technical Support.

Use the following steps to reset the health of a single cartridge.

- Display the Media Lifecycle Reports screen as described in [Generate MLM Reports on page 273](#).
- Locate the barcode of the cartridge for which you need to reset the health (see [Step 7 on page 278](#)).

- Click the green arrow button for the cartridge. The library adjusts parameters used to calculate the tape health until the reported health is Average.

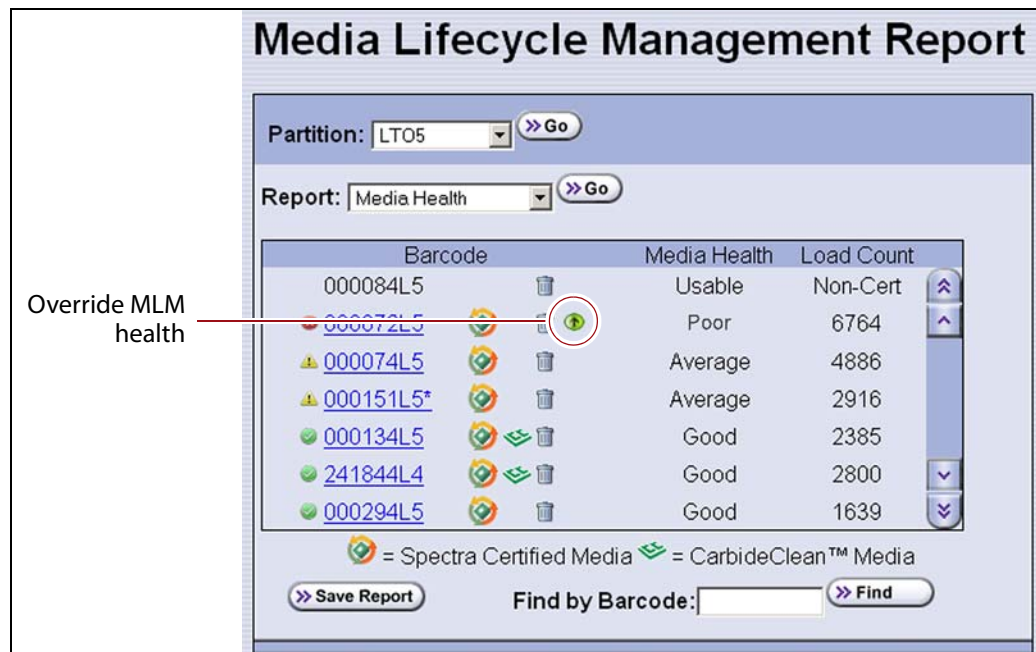

Figure 146 Click the green override button to reset the reported health for an MLM-enabled LTO cartridge.

- Attempt to resolve the issues that were causing the media health to be reported as poor.

MANAGING THE MLM DATABASE

The MLM database contains the usage history, health, and the verification data for all of the MLM-enabled cartridges in your library. It also contains the Drive Lifecycle Management data for all of the drives in your library (see [Monitoring Drive Health Using DLM on page 289](#)).

Deciding when and how often you back up the MLM database depends on many factors, including how often tapes are loaded into a drive.

- If all of the tapes are loaded into drives frequently, the MLM database can be rebuilt relatively quickly. The database can be backed up less frequently.
- If many of the tapes remain in the library without being loaded into a drive for a long period of time, or if tapes are exported and stay outside of the library for a long period of time, rebuilding the MLM database can take a long time. Back up the MLM database more frequently.

Back Up the MLM and DLM Databases

Based on your environment, determine how frequently backups are needed, then use the following steps to create a backup. You can choose to save the backup to a USB device or send it as an email attachment to a previously configured mail recipient.

1. Use your storage management software to stop all backup or restore operations on the library.



Important Backing up the MLM and DLM databases requires the library to be idle.

2. Log into the library as a user with superuser or administrator privileges.
3. If you want to backup the MLM database to a USB device, connect the device to the library and allow time for the device to mount before continuing.
4. From the toolbar menu, select **Maintenance ... Tools**. The Maintenance Tools screen displays.
5. Select **Utilities**. The Utilities screen displays.
6. Click **Show Advanced**. The Advanced Utilities Confirmation screen displays.
7. Click **Next**. The Utilities screen refreshes to show a list of the advanced utilities.
8. Scroll down and select **Save MLM Database**. The screen refreshes to show the details for the utility.

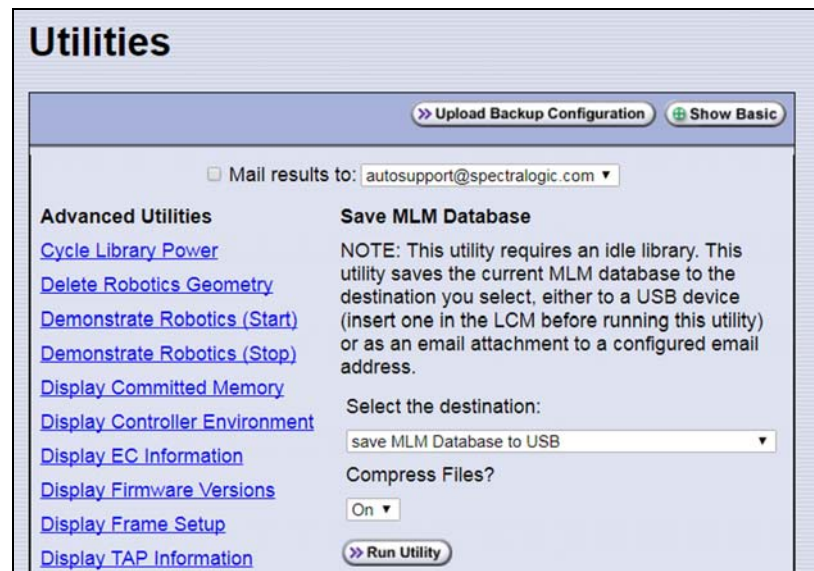

Figure 147 Select the Save MLM Database utility.

9. Use the **Select the Destination** drop-down list to select the destination for the saved file.

- Notes:**
- To send the file to someone who is not already listed as a library mail user, you must first configure that person as an email recipient as described in [Configure Mail Users on page 106](#).
 - The check box option at the top of the screen only relates to the system messages indicating that the utility completed successfully (or failed). It does not relate to the MLM database file itself.

Select this option...	To...
Save MLM Database to USB	Backup the MLM database to a USB device.
Mail MLM Database to...	Send the MLM database file as an email attachment to the specified mail recipient. Note: Do not use the default <i>autosupport@spectrallogic.com</i> email recipient. Spectra Logic does not save emailed files unless they are specifically requested for troubleshooting.

10. If you want to compress the file to make it smaller, select **On** in the **Compress Files?** drop-down list.

11. Click **Run Utility**.

After a brief delay, the Utility Results screen displays, showing that the database file was either saved or sent.

Verify the Database Backup File

After backing up the MLM database, use one of the procedures in the following table to confirm that the backup file was generated.

If the backup was...	Follow these steps...
Saved to a USB Device	<ol style="list-style-type: none"> 1. Plug the USB device into a PC. The PC does not need to be connected to the library. 2. Examine the list of files on the USB device and locate the SavedMLMDB folder. 3. Open the folder to verify that it contains the following file, where <i><date-time></i> is the time stamp for when the backup was created: <ul style="list-style-type: none"> ▪ <code>xmlinfo<date-time>.db</code> —OR— ▪ Zippered file — <code>cminfo_<date-time>.zdt</code> 4. Verify that the file is more than 0 bytes in size. 5. If a file with the correct filename format is present and is more than 0 bytes in size, the database backup was successful and the file is usable. Store the USB device in a safe location. 6. If the MLM database file is not present or if it is 0 bytes in size, repeat the backup process (Back Up the MLM and DLM Databases on page 282) using a different USB device.
Sent as an Email Attachment	<ol style="list-style-type: none"> 1. Open the email attachment and verify that: <ul style="list-style-type: none"> ▪ The attachment contains a zip file called <code>cminfo_<date-time>.zdt</code> —AND— ▪ The file is more than 0 bytes in size. 2. If the zip file is present and is more than 0 bytes in size, the backup was successful and is usable. Save the email attachment to a safe location from which you can copy it to a USB device, if needed. 3. If the zip file is not present or if it is 0 bytes in size, repeat the backup process (Back Up the MLM and DLM Databases on page 282) to generate the email again.

Delete MLM Records From the Database

When the maximum number of records for the MLM database is reached, the record for the least recently exported cartridge, as determined by the Export Date tracked by MLM, is automatically deleted. The library does not notify you when it reaches the maximum number of records.

When a tape is retired or permanently exported from the library, you can manually delete its record from the MLM database. Records can be deleted individually or as a group.

Delete an Individual Record

If you only need to delete one or two cartridges from the MLM database, you can use the Media Lifecycle Report screen to delete individual records.

1. Log into the library as a user with superuser or administrator privileges.
2. Display the Media Lifecycle Reports screen as described in [Generate MLM Reports on page 273](#).
3. Locate the barcode of the cartridge you want to remove from the MLM database (see [Step 7 on page 278](#)).

Note: An asterisk (*) next to the barcode indicates that the cartridge was exported from the library.

4. Click the trash can icon next to the barcode to delete the record.

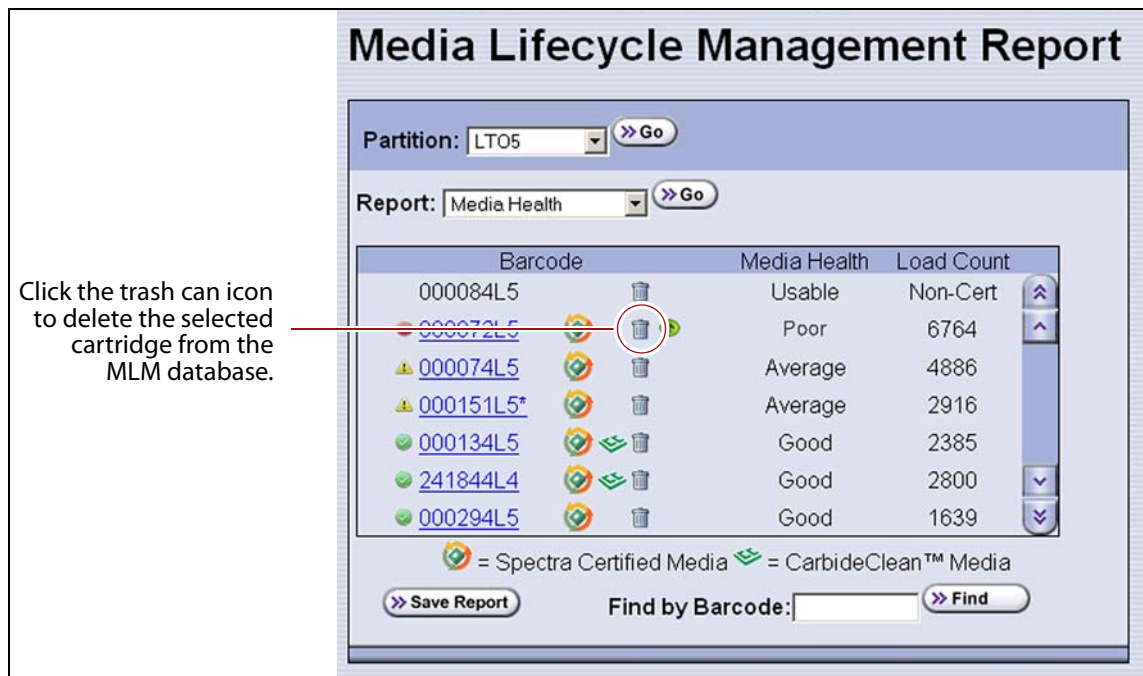

Figure 148 Use the trash can icon to delete individual records from the MLM database.

5. Respond to the confirmation message to delete the record.

Delete Multiple Records

1. Log into the library as a user with superuser or administrator privileges.
2. From the toolbar menu, select **Maintenance ... Media Lifecycle Management**. The Media Lifecycle Management Tools screen displays.

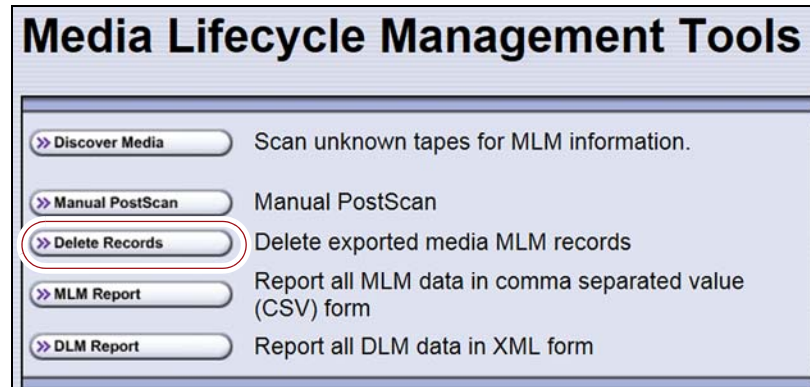

Figure 149 Click **Delete Records** on the MLM Tools screen to begin removing records from the MLM database.

3. Click **Delete Records**. The Delete MLM Records screen displays.

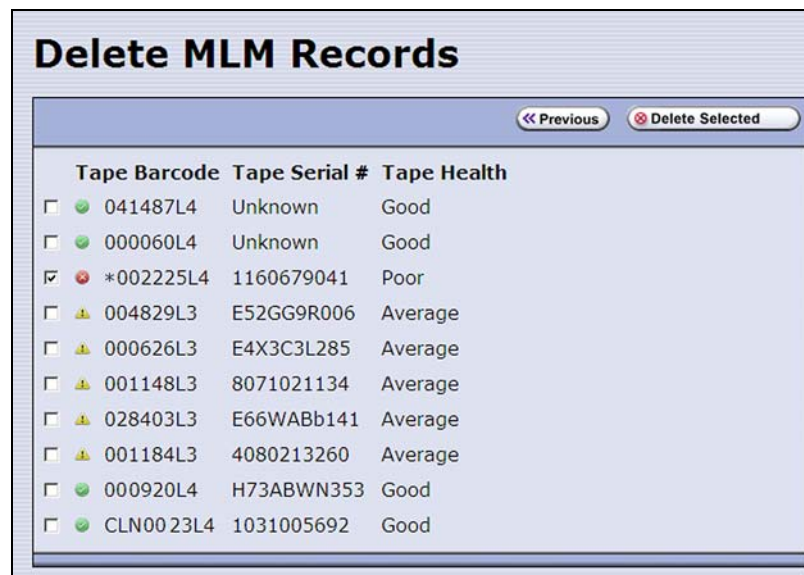

Figure 150 Select the cartridges to remove from the MLM database on the Delete MLM Records screen.

4. Select the cartridge records you want to delete from the MLM database.

Note: An asterisk (*) indicates that the cartridge was exported from the library.
5. Click **Delete Selected** to remove the selected records from the MLM database.

Download the MLM Database for Analysis and Archival

If desired, you can download the MLM database as a comma-separated-value (CSV) file for analysis and archival. You can then open the file in any software application that supports this type of file (for example, spreadsheet software) and view the information it contains.



Important

The MLM information contained in the CSV file cannot be used to restore the MLM database. Always maintain a current backup of the MLM database as described in [Back Up the MLM and DLM Databases](#) on page 282.

Note: The **MLM Report** button is only available when you access the library using the BlueScale web interface (RLC). It is not available from the operator panel.

1. Log into the library as a user with superuser or administrator privileges.
2. From the toolbar menu, select **Maintenance ... Media Lifecycle Management**. The Media Lifecycle Management Tools screen displays.

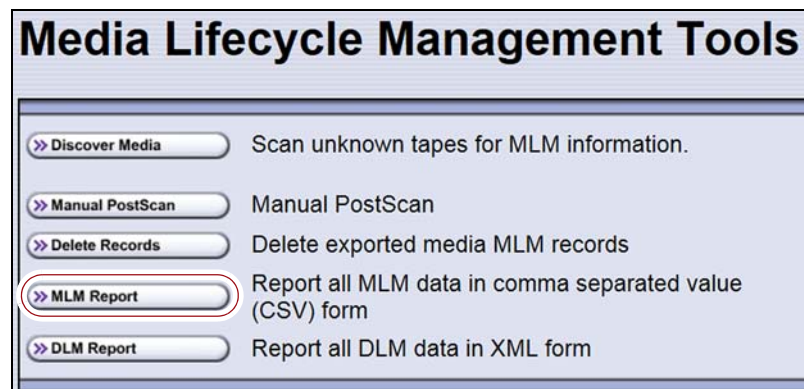

Figure 151 Click **MLM Report** on the MLM Tools screen.

3. Click **MLM Report** and use your browser's Open File dialog box to open or save the file.
4. To view the information stored in the MLM database, open the CSV file using a software program that supports this file type.

	A	B	C	D	E	F	G	H	I
1	Barcode	Health	Load	Media Type	Write Protected	Born On Date	Encryption	Cleans Remaining	First Write Time
2	041487L4	Usable	Non-Cert	Data Cartridge	Non-Cert	Non-Cert	Non-Cert	Non-Cert	Non-Cert
3	000060L4	Usable	Non-Cert	Data Cartridge	Non-Cert	Non-Cert	Non-Cert	Non-Cert	Non-Cert
4	002225L4	Poor	1888	Data Cartridge	No	11/12/2008	None	0	12/9/2008 16
5	004829L3	Average	5204	Data Cartridge	No	3/2/2009	None	0	12/31/1969 16
6	000626L3	Average	2785	Data Cartridge	No	3/25/2009	None	0	12/31/1969 16
7	001148L3	Average	2419	Data Cartridge	No	7/1/2009	None	0	12/31/1969 16
8	028403L3	Average	3005	Data Cartridge	No	7/1/2009	LTO4 Native	0	12/31/1969 16

Figure 152 An example of the downloaded MLM database file (opened in Microsoft Excel).

CHAPTER 10

Using Drive Lifecycle Management

This chapter describes how to use BlueScale Drive Lifecycle Management to proactively monitor the health of the drives in your library.

Topic	
BlueScale Drive Lifecycle Management	this page
Monitoring Drive Health Using DLM	page 289
Using the Drive Health Icons	page 291
Viewing and Saving a Detailed Drive Health Report	page 293
Downloading the DLM Database	page 295

BLUESCALE DRIVE LIFECYCLE MANAGEMENT

Overview BlueScale Drive Lifecycle Management works in conjunction with MLM to help you identify drives that experience a high number of errors or other problems during operation.

Each time a cartridge is unloaded from a drive, the library collects the media health data from the drive. This data includes read/write errors, tape alerts, and flags generated during the time the most recent cartridge was loaded in the drive. It also includes the current value for the drive's single character display (SCD) and any errors detected at the time the cartridge is unloaded. All of this data, plus the MLM data for the 50 most recently loaded cartridges, is stored in the DLM database. This data is used to generate an overall drive health status for the library, as well as health reports for each individual drive.

Enabling DLM BlueScale Drive Lifecycle Management (DLM) is automatically enabled when Media Lifecycle Management (MLM) is enabled and cannot be used without MLM. See [Chapter 9 – Configuring and Using Media Lifecycle Management](#), beginning on page 243 for detailed information about enabling and using MLM.

Drive Health Reports A health icon next to each drive indicates the overall health of the drive. Detailed reports provide information about the cartridges that were loaded into the drive and any errors reported. The DLM database containing the health information for every drive in the library is backed up whenever the MLM database is backed up. The reports can also be saved and exported as XML files.

Drive Testing If a drive is experiencing problems, the DLM drive test wizard lets you test the basic functionality of the drive. This test, when used in conjunction with other DLM data and MLM data, can help you determine whether a drive or the media is the source of the errors you are investigating.

User Privilege Requirements Only a user with superuser or administrator privileges can access and use the DLM features.

MONITORING DRIVE HEALTH USING DLM

When DLM is enabled, the Drives icon in the Configuration toolbar changes to the DLM icon. Selecting DLM from the toolbar displays the Drives screen, which uses health icons to provide at-a-glance information about the health of each drive in the library. From the Drives screen you can access detailed drive health reports for each drive in the library, as well as drive management tools.

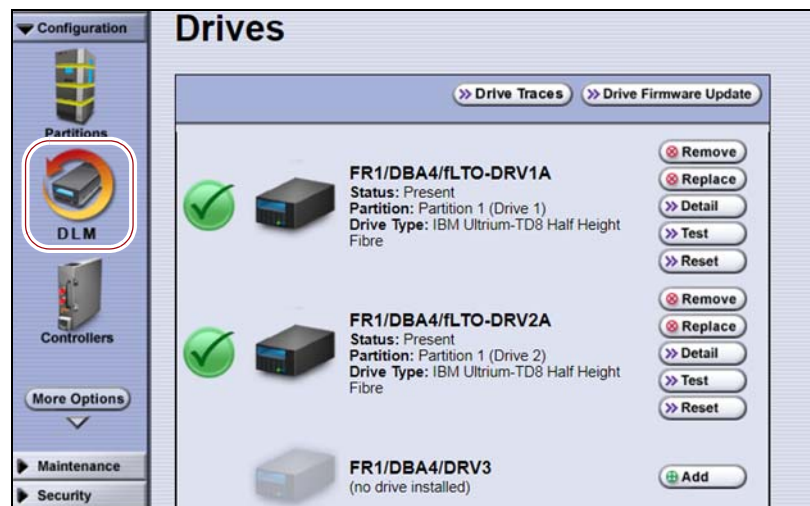

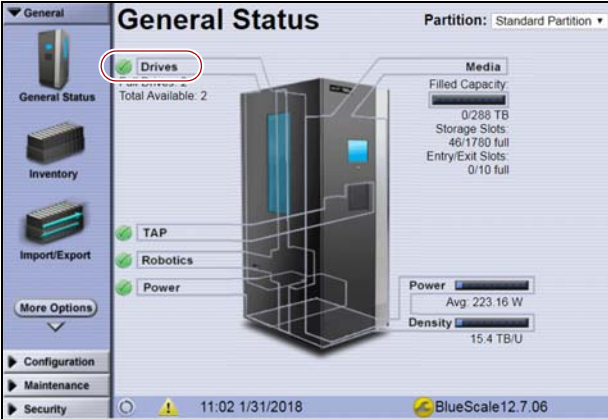

Figure 153 Enabling DLM changes the Drive icon in the Configuration toolbar.

Each button on the Drives screen lets you perform additional operations.

This button...	Lets you...
Drive Traces	Collect drive traces for LTO drives (see Use the Drive Traces Button on page 357). Note: The Drive Traces button is not supported for TS11xx technology drives.
Drive Performance Monitoring	Display the drive performance statistics screen (see View Drive Performance Statistics on page 149). Note: This button is only present when Drive Performance monitoring is enabled (see Enable Drive Performance Monitoring on page 101).
Drive Firmware Update	Use one or more firmware update (code load) tapes stored in the partition's entry/exit pool to update the firmware for selected drives (see Updating Drive Firmware on page 419).
Remove Replace Add	Remove or replace a drive that is already in the library (see Adding or Replacing a Drive on page 442). If a DBA has an empty drive bay, the Add button powers on a newly installed drive and initializes it in the library. Note: The Add button is only present if a DBA location does not contain a drive.
Detail	View detailed information about the selected drive (see Viewing and Saving a Detailed Drive Health Report on page 293).
Test	Use the DLM Drive Test wizard to test a drive (see Using DLM to Test a Drive on page 379).
Reset	Reset the drive, which power cycles the drive, runs the internal drive diagnostics, and reinitializes it in the library (see Resetting a Drive on page 351).





Using the Drive Health Icons

The drive health icons provide at-a-glance health status for the drives in the library. The icons appear on the following screens, as well as in the drive health reports (see [Viewing and Saving a Detailed Drive Health Report](#) on page 293).

The health icon on this screen...	Indicates...
<p>General Status</p>  <p>The screenshot shows the 'General Status' interface. On the left sidebar, the 'Drives' icon is circled in red. The main area displays a 3D rack view with various components labeled: 'TAP', 'Robotics', and 'Power', each with a green checkmark. On the right, there are 'Media' and 'Power' sections with various metrics and progress bars. The bottom status bar shows the time '11:02 1/31/2018' and the version 'BlueScale12.7.06'.</p>	<p>The overall drive health for the selected partition.</p> <p>Note: The drive health icon on the General Status screen reflects the lowest health score for the drives in the partition being viewed.</p>
<p>Drives</p>  <p>The screenshot shows the 'Drives' screen. A green drive health icon is circled in red next to the drive entry for 'FR1/DBA4/fLTO-DRV1A'. The entry includes details: 'Status: Present', 'Partition: Partition 1 (Drive 1)', and 'Drive Type: IBM Ultrium-TD8 Half Height Fibre'. Action buttons for 'Remove', 'Replace', 'Detail', 'Test', and 'Reset' are visible to the right of the drive entry.</p>	<p>The overall health of each individual drive in the library.</p>
<p>Drive Details</p>  <p>The screenshot shows the 'Drive FR1/DBA4/fLTO-DRV1A Details' screen. A green drive health icon is circled in red. Below it, various drive parameters are listed: 'Drive WWN: 21 41 00 90 A5 00 62 16', 'Spectra Drive SN: 1041006216', 'Mfg Drive SN: 10WT000267', 'Drive FW: HB83', 'DCM FW: 7.6.0', 'POST Status: Complete', 'Cleaning Status: Drive Clean', 'LED Status: Off', 'Display Character (SCD): 0', 'No Error', and 'Cartridge Status: Compression Enabled, No tape motion'.</p>	<p>The health of the selected drive.</p>

The drive health icon state is based on data collected for the drive when the last cartridge was loaded in the drive. This data consists of the code presented on the drive's SCD or MCD, as well as tape alerts, and errors detected at the time the tape is unloaded. See [Interpreting the SCD and MCD Codes on page 366](#) for detailed information about the SCD and MCD codes. The following table describes the drive health status icons.

Note: Not all SCD and MCD codes have an associated DLM icon.

Icon	Meaning
	The drive health is Good . The drive is operating normally.
	The drive requires Attention . Use the SCD or MCD code information on the Drive Details screen to determine the type of action required. See Interpreting the SCD and MCD Codes on page 366 to determine what action is needed to address the condition.
	The drive health is Poor . The drive experienced an unrecoverable error or problem. Use the SCD or MCD code information on the Drive Details screen to determine the type of action required. See Interpreting the SCD and MCD Codes on page 366 to determine what action is needed to address the condition.
	The drive health is Unknown . The status of the drive cannot be determined.

Viewing and Saving a Detailed Drive Health Report

1. Log into the library as a user with superuser or administrator privileges.
2. From the toolbar menu, select **Configuration**  **DLM** to display the Drives screen.

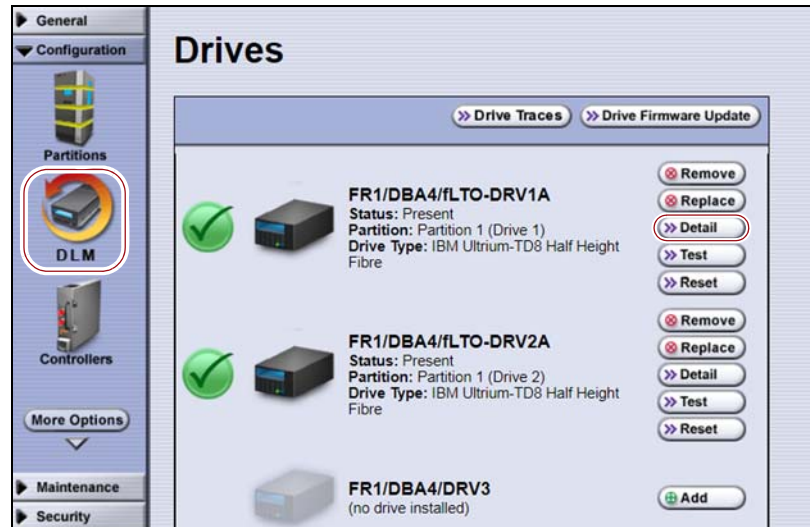

Figure 154 Click **Detail** to view detailed information about a drive.

3. Click **Detail** next to the drive for which you want to view more information. The Drive Details screen displays.

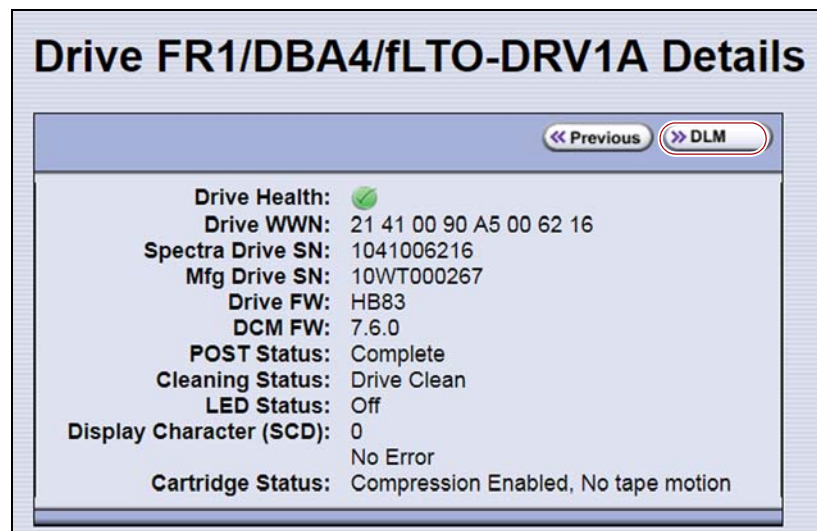



Figure 155 The Drive Details screen shows detailed information about the selected drive.

- Click **DLM** on the Drive Details screen to view a detailed Drive Lifecycle Management report.

Note: The **DLM** button on the Drive Details is not present if MLM and DLM are not enabled (see [Enable and Configure MLM PreScan and PostScan on page 178](#)).

The Drive Lifecycle Management Report screen is divided into three panes, which are described in the following table.

This pane...	Shows...
Drive health overview	<p>The drive identifier and any status information. The drive health icon indicates the drive's overall health at the time the screen was displayed.</p>  <p>Figure 156 Check the drive health icon for the overall health of the drive.</p>
Summary of tapes	<p>The barcode label information and health information for the last 10 cartridges loaded into the drive. The health icon indicates the cartridge health at the time the cartridge was unloaded from the drive (Tape Health at Unmount) and the current health status stored in the MLM database (Current Tape Health). Refer to the table on page 276 of Chapter 9 – Configuring and Using Media Lifecycle Management, beginning on page 243 for descriptions of the icons related to media health.</p> <p>Note: Depending on the drive's history, this pane may not have any entries.</p>  <p>Figure 157 The Summary of tapes pane shows the barcode label information and health information for the last 10 cartridges loaded into the drive.</p>

This pane...	Shows...
History of tapes	<p>Detailed information about the last 50 cartridges loaded into the drive as well as any Tape Alerts and SCD or MCD codes posted by the drive while the tape was loaded in the drive.</p> <div data-bbox="446 331 1182 630" style="border: 1px solid black; padding: 5px;"> <p>History of tapes loaded in this drive (most recent first)</p> <p>Mount 1</p> <p style="padding-left: 40px;">Time: 06/03/2011 00:16:22</p> <p style="padding-left: 40px;">Barcode: 000060L4</p> <p style="padding-left: 40px;">Mfg SN: H731H4M009</p> <p style="padding-left: 40px;">Tape Health: ✔</p> <p style="padding-left: 40px;">Drive Health: ✔</p> <p style="padding-left: 40px;">Tape Alerts: 00 00 00 00 00 00 00 00</p> <p style="padding-left: 40px;">Display Character (SCD): 0 (No Error)</p> </div> <p>Figure 158 The History of tapes pane.</p> <p>Notes:</p> <ul style="list-style-type: none"> ▪ Depending on the usage history for the drive, this pane may not have entries. ▪ For detailed information about Tape Alerts, log on to the portal (see Accessing the Technical Support Portal on page 444), open the Knowledge Base, and search for KBA-01769, <i>What do the tape alert flags in the DLM pages mean?</i>. Refer to the tape drive documentation for additional information

5. To save the information on the Drive Lifecycle Management screen, use the Save MLM Database utility as described in [Back Up the MLM and DLM Databases on page 282](#).
6. If you correct a condition that changed the drive's health to yellow or red, click **Reset Health** to reset the drive health to Good (Green). Click **Continue** to complete the reset health process.

- Notes:**
- If the condition was not truly corrected, the next tape load sets the drive health back to the previous indication.
 - Resetting the drive health deletes the drive's Summary of Tapes and History of Tapes data.

DOWNLOADING THE DLM DATABASE

If desired, you can open and save the DLM database as an XML file. This file contains the same information that appears on the Drive Lifecycle Management screen (see [Step 4 on page 294](#)).



Important

The DLM database information in the XML file cannot be used to restore the DLM database. The information required to restore the DLM database is backed up with the MLM database. See [Back Up the MLM and DLM Databases on page 282](#) for information about backing up the MLM database.

Note: The **DLM Report** button is only available when you access the library using the BlueScale web interface (RLC). It is not available from the operator panel.

Use the following steps to save the DLM database:

1. Log into the BlueScale web interface (RLC) as a user with superuser or administrator privileges.
2. From the toolbar menu, select **Maintenance ... Media Lifecycle Management**. The Media Lifecycle Management Tools screen displays.

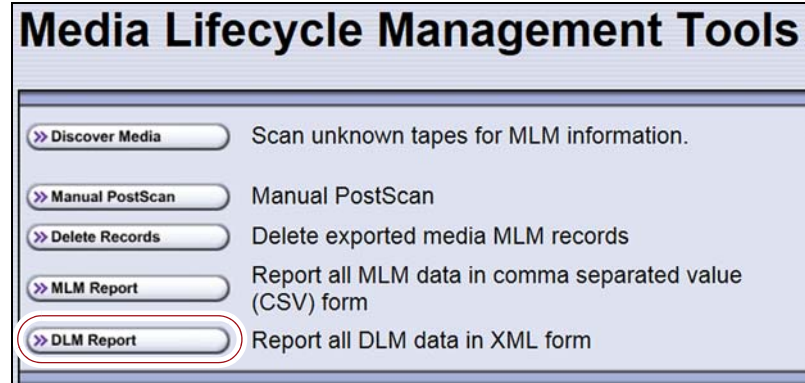

Figure 159 Click **DLM Report** on the Media Lifecycle Management Tools screen to export the DLM database as an XML file.

3. Click **DLM Report**. The XML file opens in the application associated with that file type on the computer accessing the library's BlueScale web interface.

Note: Typically, the application associated with XML files is a web browser. Depending on the browser, the file may open in a new browser window.



Figure 160 The DLM database XML file opened in a web browser.

4. Use the **File ... Save** option in the application that opened the XML file to save it to a known location on your computer.
5. You can open the saved XML file using Microsoft Excel 2007 or later, or use another program that supports the XML file format.

CHAPTER 11

Configuring and Using AutoSupport

This chapter describes how to configure and use AutoSupport with your library. All AutoSupport functionality is included with your library purchase.

Topic	
AutoSupport Overview	this page
Configuring AutoSupport	page 300
Configure Mail Recipients	page 300
Configure AutoSupport Profiles	page 301
Configure Alarms	page 305
Configure Log Set Forwarding	page 307
Using AutoSupport	page 308
Create New Support Tickets	page 308
Update Existing Support Tickets	page 312

AUTOSUPPORT OVERVIEW

AutoSupport configures the library to automatically notify support personnel or others with messages or when specific events occur. It can also be used to open or update a support ticket and send it to a specified recipient or to Spectra Logic Technical Support. AutoSupport can be used without configuring the library with email access by saving the ASL sets generated by AutoSupport to a USB device and then manually sending an email containing the stored information to Spectra Logic Technical Support.

Note: AutoSupport Log (ASL) information is only for troubleshooting purposes. This log information is separate from the data path and contains no customer data.

Send Log Sets

This feature lets you manually generate a standard AutoSupport Log (ASL) set (file) and email it to a pre-configured recipient or save it to a USB device. You can use the Send Log Sets option to open or update a support ticket and send it to a specified recipient or to Spectra Logic Technical Support. The ASL included in the support ticket includes the following types of information:

- Library message logs
- Library Control Module (LCM) logs
- LCM configuration (including the current physical configuration)
- A simplified report of the MLM and DLM databases
- EC data from all components
- BlueScale version
- Contact information for data center staff
- Other library information specified in the AutoSupport user profile

Log Forwarding

This feature configures the library to send monthly ASL files to preconfigured recipients (see [Configure Log Set Forwarding on page 307](#)).

Critical Alarms

When you enable critical alarms, the library automatically generates an ASL file whenever any of the events in the following table occurs. If you configured one of your AutoSupport profiles as the AutoSend Profile (see [Step 4 on page 303](#)), the library automatically sends the ASL file to the mail recipients in the AutoSend profile.

Note: If you select *autosupport@spectralogic.com* as a mail recipient in the AutoSend profile, the library also sends the ASL file and a ticket request to Spectra Logic Technical Support.

For this event...	An AutoSupport ticket request is generated...
Motion Restart	Whenever motion restarts. Each motion restart is treated as a separate event and results in generation and submission of an AutoSupport ticket request.
Front or Side Panel Opened or Removed	If a library side panel or front panel is opened or removed three times within thirty minutes. Only one AutoSupport ticket request is generated for each 30-minute time period.
Power Supply Failure	When a power supply fails. Each power supply is evaluated separately. Only one AutoSupport ticket request per power supply is generated for each 24-hour time period, even if the power supply fails and then resumes operation repeatedly. If two power supplies fail during the same 24-hour time period, two separate AutoSupport ticket requests are generated, one per failed power supply.

For this event...	An AutoSupport ticket request is generated...
RIM Failure	<p>Whenever the library detects that a RIM is no longer present. Only RIMs that are configured as part of a partition generates an AutoSupport ticket request. The following problems can generate a RIM failure event:</p> <ul style="list-style-type: none"> ▪ Failure of the RIM software or hardware. ▪ Loss of communication between the library and the RIM. ▪ Removal of a RIM from the library without using the BlueScale Controller Remove or Controller Replace operation. <p>AutoSupport ticket requests are not generated if the RIM is removed following a Controller Remove or a Controller Replace operation.</p> <p>Each RIM is evaluated separately. Only one AutoSupport ticket request per RIM is generated for each 24-hour time period, even if the RIM fails and then resumes operation repeatedly. If two RIMs fail during the same 24-hour time period, two separate AutoSupport ticket requests are generated, one per failed RIM.</p>
Drive Failure	<p>When the library detects a drive failure that results in the percentage of failed drives in a partition meeting or exceeding the specified threshold (see Configure Alarms on page 305).</p> <p>The following drive problems can generate a drive failure event:</p> <ul style="list-style-type: none"> ▪ Failure of the drive software or hardware. ▪ Loss of communication between the library and the drive. ▪ Removal of a drive from the library without using the BlueScale Drive Remove or Drive Replace operation. <p>AutoSupport ticket requests are not generated if the drive is removed following a Drive Remove or a Drive Replace operation.</p>
Library Controller Fails to Initialize	If the library controller (LC) fails to properly initialize.

CONFIGURING AUTOSUPPORT

If you have any questions about configuring AutoSupport, contact Spectra Logic Technical Support (see [Contacting Spectra Logic on page 7](#)).

Note: To simplify entering the information required to configure and use AutoSupport, use the BlueScale web interface or a keyboard attached to the LCM.

Network and Support Contract Requirements Before you configure AutoSupport, Spectra Logic recommends connecting the library to an email gateway. You need to do the following:

- Connect an Ethernet cable to the Ethernet connector on the LCM (see [Figure 9 on page 39](#)).
- Obtain the library's IP address, subnet, and gateway address (see [Configure Network Settings on page 104](#)).

User Privilege Requirements Only a user with superuser or administrator privileges can configure the AutoSupport features.

Configure Mail Recipients

If not already completed, configure one or more mail recipients who should receive AutoSupport information (see [Configure Mail Users on page 106](#)). At a minimum, configure Spectra Logic Technical Support (*autosupport@spectralogic.com*) as a mail recipient if you want to automatically send AutoSupport ticket requests to Spectra Logic Technical Support. If desired, you can configure additional recipients.

- Notes:**
- The default *autosupport@spectralogic.com* mail recipient can be used for any ASL or HHM files that are generated by the library. This includes those generated manually, or automatically in response to critical events or log forwarding.
 - Do not configure the *autosupport@spectralogic.com* mail recipient to receive messages that result from configuration changes or system messages generated by the library.
 - AutoSupport can be used without email access by saving the information generated by AutoSupport to a USB device and then manually sending the stored information to Spectra Logic Technical Support.

Configure AutoSupport Profiles

Use the following steps to create or modify a profile for each person assigned to work with Spectra Logic Technical Support to troubleshoot problems with the library or drives.

1. Log into the library as a user with superuser or administrator privileges.
2. If not already completed, configure the mail recipients who should receive AutoSupport information (see [Configure Mail Recipients on page 300](#)).
3. From the toolbar menu, select **Maintenance** ... **AutoSupport**. The AutoSupport screen displays.

Note: If you did not yet configure an AutoSupport profile, the **Send Log Set** button is grayed out. If you did not configure a profile for AutoSend, the **Configure Alarms** button is grayed out.

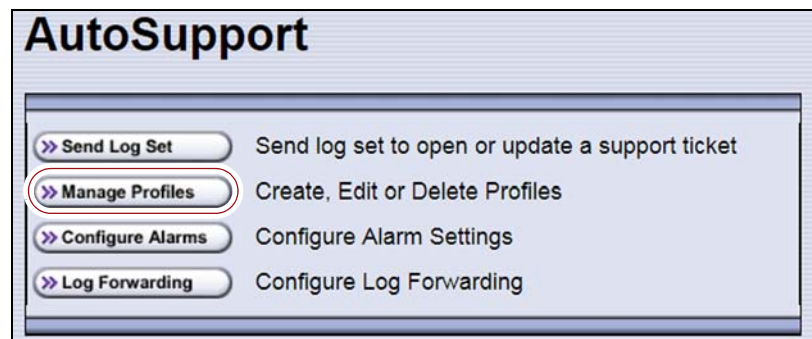

Figure 161 Click **Manage Profiles** to create or edit an AutoSupport profile.

4. Click **Manage Profiles**. The AutoSupport Profiles screen displays.



Figure 162 Use the AutoSupport Profiles screen to manage profiles.

Create or Modify a Profile

1. Click **New Profile** to create a new profile or click **Edit Profile** to modify an existing profile. The Company Information screen displays.



Company Information

Provide your company information below. An asterisk (*) denotes that the field is required.

*Company Name:

*Address:

Address:

Site/Building Location:

Figure 163 Enter required information for your company.

- Complete the information in this screen. The information marked with an asterisk (*) is required.
- Note:** Make sure to fill in *all* of the required fields in each of the following screens. You cannot advance to the next screen if required information is missing.
- The Customer/Contract Number is no longer used. Enter any six alpha-numeric characters.
2. Click **Next**. The Contact Information screen displays.

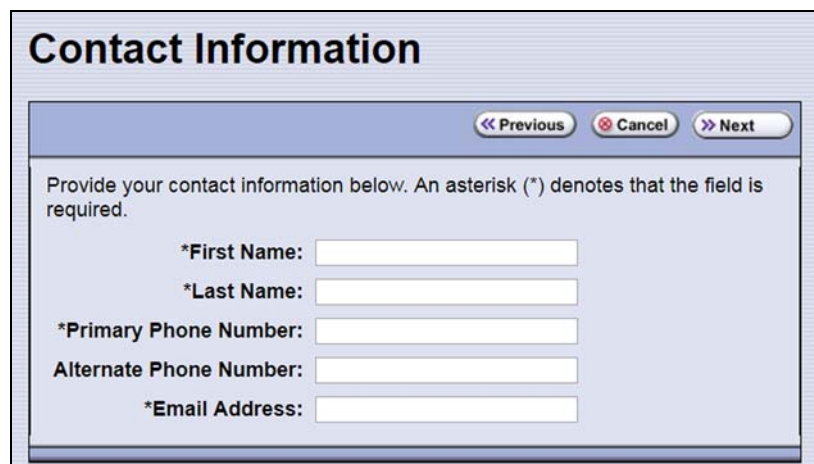

Contact Information

Provide your contact information below. An asterisk (*) denotes that the field is required.

*First Name:

*Last Name:

*Primary Phone Number:

Alternate Phone Number:

*Email Address:

Figure 164 Enter the required information for the contact person.

3. Enter the information for your contact person in the fields provided. This information determines how Spectra Logic contacts this person.

4. Click **Next**. The System and Mail Information screen displays.

Figure 165 Enter information about your operating environment.

- Enter information about your library's operating environment and storage management software in the fields provided.
- Select **AutoSend Profile** to use the current profile as the recipient for critical alarm log sets automatically sent by the library.

Note: Only one profile can be configured as the AutoSend profile.

- Select the mail recipient(s) from the **Mail To** choices presented. Only mail recipients that were previously configured are listed (see [Configure Mail Users on page 106](#)).

Note: You must select *autosupport@spectralogic.com* as one of the recipients if you want the library to send an AutoSupport ticket request to Spectra Logic Technical Support.

- Click **Next**. The Save Profile screen displays. Verify that all of the information shown is correct.

If any information needs to be changed, click **Previous** to display the screen in which the changes need to be made.

Figure 166 Review the profile information.

- When all of the information is correct, click **Save**.
- The AutoSupport Profiles screen redisplay, listing the newly completed profile.

Figure 167 All of the AutoSupport profiles are listed on the AutoSupport Profiles screen.

8. Repeat [Step 1 on page 302](#) through [Step 6 on page 304](#) if you want to create additional profiles.
Note: When you create multiple profiles, they are listed in the order in which they are created, not in alphanumeric order.
9. Click **Previous** to return to the main AutoSupport screen.
If one of the profiles is configured as an AutoSend recipient, the **Configure Alarms** button is active (see [Figure 161 on page 301](#)).

Delete an AutoSupport Profile

Use the following steps to delete an existing profile.

1. Log into the library as a user with superuser or administrator privileges.
2. From the toolbar menu, select **Maintenance**  **AutoSupport**. The AutoSupport screen displays (see [Figure 161 on page 301](#)).
3. Click **Manage Profiles**. The AutoSupport Profiles screen displays (see [Figure 167 on page 304](#)).
4. Click **Remove** next to the contact you want to delete. The Remove Profiles screen displays, asking you to confirm the deletion.
5. Click **Remove**. The AutoSupport profiles screen redisplay with the updated list of profiles.
6. Click **Previous** to return to the main AutoSupport screen.

Configure Alarms

Use the steps in this section if you want the library to automatically generate an ASL file in the event that any of the critical events listed under [Critical Alarms on page 298](#) occurs.

1. If you did not already do so, configure one AutoSupport profile as the AutoSend recipient (see [Step 4 on page 303](#)).

2. Click **Configure Alarms** from the AutoSupport screen. The AutoSupport Critical Alarm Configuration screen displays.

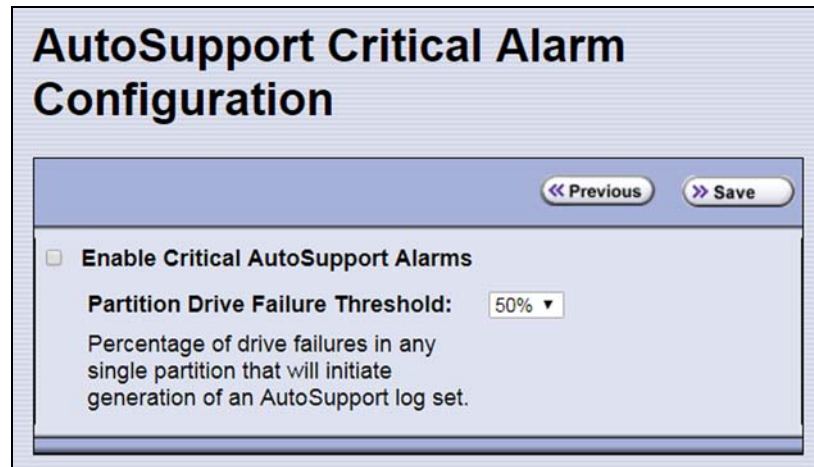

Figure 168 The AutoSupport Critical Alarm Configuration screen.

3. Select **Enable Critical AutoSupport Alarms**. When enabled, the library generates an ASL file whenever one of the critical events listed under [Critical Alarms on page 298](#) occurs. Any ASL file that is generated as a result of a critical event is automatically sent to all of the recipients selected in the AutoSend profile.

Note: The *autosupport@spectralogic.com* address must be selected as a mail recipient in the AutoSend profile if you want the library to send critical event ASL files to Spectra Logic Technical Support.

4. If desired, select a value for the **Partition Drive Failure Threshold** from the drop-down list. This is the only configurable critical event.

You can specify the threshold for the number of failed drives in a partition that causes an AutoSupport ticket request to be generated. The threshold is a percentage of drives assigned to the partition. You can select 25% or 50%; the default is 50%. The threshold applies to all partitions in the library.

5. Click **Save** to save your changes or click **Previous** to return to the main AutoSupport screen without saving your changes.

After your changes are saved, the AutoSupport Critical Alarm Configuration screen redispays with a confirmation message.

6. Click **Previous** to return to the main AutoSupport screen.

Configure Log Set Forwarding

Log forwarding is enabled by default from the factory. This is a monthly log set that is forwarded to Spectra Logic for data collection. No action is taken by Spectra Logic Technical Support for a particular library when the log set is received, but the data is parsed and stored in our database to better understand our field population and how the library is used and how it can be improved.

Use the following steps to modify log set forwarding.

1. Click **Log Forwarding** from the main AutoSupport screen. The Configure Log Forwarding screen displays.

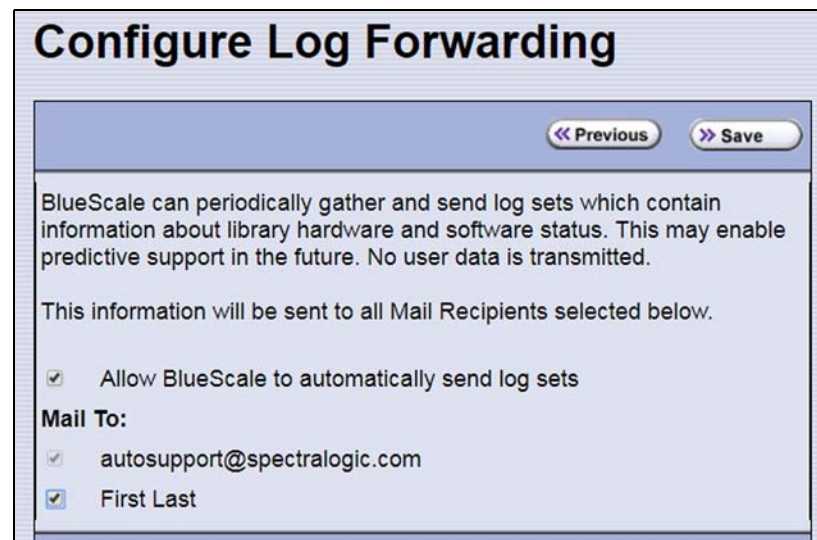

Figure 169 The Configure Log Forwarding screen.

2. Select the forwarding options you want to use.
 - **Allow BlueScale to automatically send log sets** is selected by default. Clear the check box if you do not want the library to automatically generate and submit monthly Auto Support Log sets to one or more preconfigured recipients.
 - The *autosupport@spectralogic.com* mail recipient is automatically selected. All ASL files generated by the library are automatically sent to Spectra Logic Technical Support.
 - Select any additional mail recipient(s) from the **Mail To** choices presented. Only mail recipients that were previously configured are listed (see [Configure Mail Users on page 106](#)).
3. Click **Save**.

After your changes are saved, the Configure Log Forwarding screen redisplay with a confirmation message.
4. Click **Previous** to return to the main AutoSupport screen.

USING AUTOSUPPORT

AutoSupport provides the easiest way to open a support ticket or incident. The following sections describe how to open or update a support ticket using AutoSupport.

You can also open a support incident using the Spectra Logic Technical Support portal. For instructions on submitting a support incident through the support portal, see [Opening a Support Ticket on page 448](#).

User Privilege Requirements Only a user with superuser or administrator privileges can open and modify support tickets using AutoSupport.

Create New Support Tickets

- Notes:**
- If *autosupport@spectralogic.com* is included in the **Mail To:** field for the autosupport profile used to submit a ticket, then Spectra Logic immediately sends a confirmation email to the email address listed in the autosupport profile used to submit the ticket, and a support person contacts the person submitting the ticket during normal service contract hours.
 - If it is during your service contract hours and the problem requires immediate attention, call Spectra Logic Technical Support after submitting the AutoSupport ticket (see [Contacting Spectra Logic on page 7](#)).
 - Go to Spectra Logic's website at: support.spectralogic.com/services-and-contracts/support-offerings/ for information about the warranty and service options for your library.

Follow these steps to open a new ticket with Spectra Logic Technical Support.

1. Log into the library as a user with superuser or administrator privileges.
2. From the toolbar menu, select **Maintenance**  **AutoSupport**. The main AutoSupport screen displays.

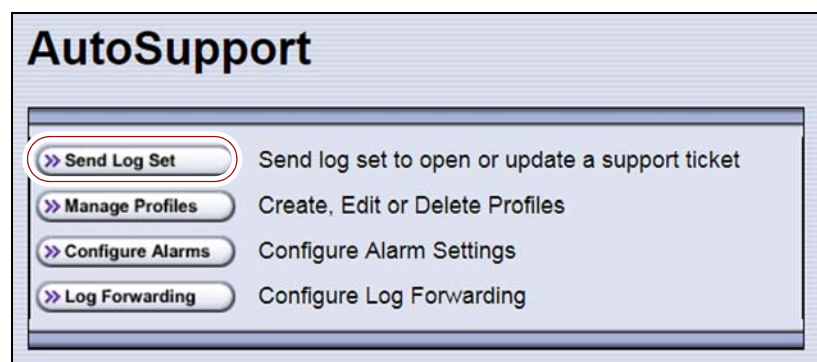

Figure 170 The main AutoSupport screen.

3. If you want to save the AutoSupport ticket information to a USB device, connect the device to USB port on the LCM (see [Figure 9 on page 39](#)) or operator panel and allow time for the device to mount before proceeding.

Note: The option to save the ticket to a USB device is only available if you connect a USB device to the library before you click **Send Log Set**.
4. Click **Send Log Set**. The Select Profile To Send Log Set screen displays.



Figure 171 AutoSupport Profiles screen.

5. Click **Select** next to the profile for the main contact person for the issue. The Select Ticket Type screen displays.

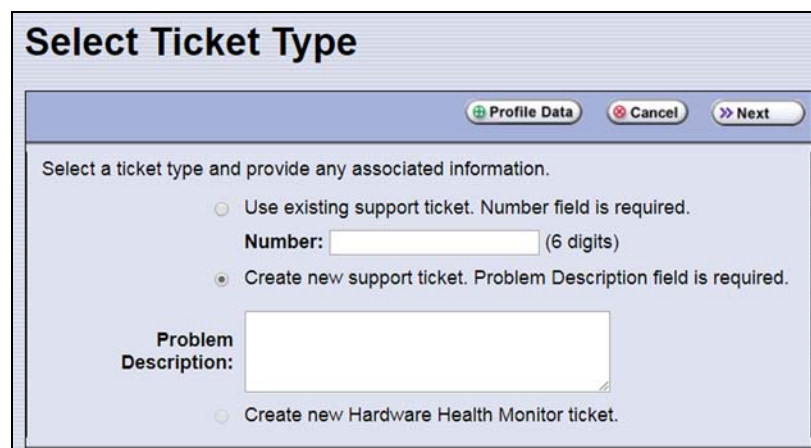

Figure 172 The Select Ticket Type screen.

- If you are sending additional information about an existing support ticket, select **Use existing support ticket** and enter the ticket number in the **Number** field. See [Update Existing Support Tickets on page 312](#) for additional information.

- If this is a new ticket, select **Create new support ticket**. This option is selected by default.

Note: The **Create new Hardware Health Monitor ticket** option is not available when you use the **Send Log Set** option to send an AutoSupport ticket. This option is only used to send HHM data in response to a maintenance notification (see [Respond to HHM Notifications on page 324](#)).

6. If you do not need to make any changes to the contact person's information for this support ticket, proceed to [Step 7](#).
 - If you need to *temporarily* change the contact person's information for this ticket, click **Profile Data**. The Profile Summary screen displays.

Make any necessary changes in the Profile Summary screen, then click **Use Settings**. The Select Ticket Type screen redisplay.

The screenshot shows the 'Profile Summary' screen with the following fields and values:

- *Company Name:** Spectra Logic
- *Address:** Colorado
- Address:** (empty)
- Site/Building Location:** (empty)
- *First Name:** First
- *Last Name:** Last
- *Primary Phone:** 3035551234
- Alternate Phone:** (empty)
- *Email Address:** name@company.com
- Host Operating System:** (empty)
- Host Backup Software:** (empty)
- System Notes:** (empty text area)
- Mail To:**
 - First Last
 - autosupport@spectralogic.com

Buttons at the top right: **Cancel** and **Use Settings** (highlighted with a red circle).

Text below the buttons: "The summary for profile First Last is outlined below. These settings will be used for the current trouble ticket only. To save these settings permanently, use the profile wizard."

Figure 173 The Profile Summary screen.

- Click **Cancel** to return to the Select Ticket Type screen without making any changes to the contact person's information.

7. In the Select Ticket Type screen (Figure 172 on page 309), type a detailed description of the issue in the **Problem Description** field, including what happened just before the failure occurred.

Note: Supplying a detailed problem description helps support personnel to address the issue more quickly and efficiently.

8. Click **Next**. The Confirm and Submit Ticket screen displays.

Figure 174 The Confirm and Submit Ticket screen.

9. Verify that all information is correct.

If...	Then...
The library is not connected to a network with an SMTP server,	<p>Select the check box at the top of the screen (shown in Figure 174) to save the ticket information to a USB device <i>instead</i> of emailing it from the library.</p> <p>Notes:</p> <ul style="list-style-type: none"> ▪ The option to save the ticket to a USB device is only available if you connected a USB device to the library before you clicked Send Log Set to begin the ticket process. ▪ After saving the ticket information to the USB device, you can upload it to the Technical Support portal (see Accessing the Technical Support Portal on page 445).
All of the information is correct,	<p>Click Submit. A progress screen indicates that the ticket request (with log information) is being sent. When completed, the AutoSupport Profiles screen displays.</p> <p>When Spectra Logic receives the request, a ticket is opened and an email response is sent to the user with a ticket number.</p>

If...	Then...
You need to change the problem description,	<ol style="list-style-type: none"> 1. Click Previous to return to the Select Ticket Type screen. 2. Modify the problem description as required. 3. Click Next to return to the Confirm and Submit Ticket screen.
You need to change the contact person's information,	<ol style="list-style-type: none"> 1. Click Previous to return to the Select Ticket Type screen. 2. Click Profile Data on the Select Ticket Type screen to display the Profile Summary screen. 3. Make any necessary changes in the Profile Summary screen. 4. Click Use Settings. The Select Ticket Type screen reappears 5. Retype the problem description. 6. Click Next to return to the Confirm and Submit Ticket screen.

Update Existing Support Tickets

Follow these steps to update a ticket that you previously opened with Spectra Logic Technical Support. Updating a ticket is particularly useful for mailing new logs to Technical Support.

Note: You must have the reference number for the existing ticket — which you receive when you open the ticket — and the information you are sending must be related to *that* ticket.

If you have a new issue with your library, open a new ticket to address that issue separately.

1. If you plan to save the ticket information to a USB device, connect the device to a USB port on the LCM (see [Figure 9 on page 39](#)) or operator panel and allow time for the device to mount.
2. Follow the instructions in [Step 1 on page 308](#) through [Step 5 in Create New Support Tickets](#) to reach the Select Ticket Type screen (see [Figure 172 on page 309](#)).
3. If you do not need to make any changes to the contact person's information for this ticket, proceed to [Step 5](#).
If you need to *temporarily* change any of the contact person's information, click **Profile Data**. The Profile Summary screen displays (see [Figure 173 on page 310](#)).
4. Make any necessary changes in the Profile Summary screen, then click **Use Settings**. The Select Ticket Type screen redisplay.
5. Select **Use existing support ticket**.
6. Type the six-digit ticket number in the Number field. You received this number when you originally opened the ticket.
7. Add any updated information in the **Problem Description** field.
8. Click **Next**. The Confirm and Submit Ticket screen displays (see [Figure 174 on page 311](#)).

9. Verify that all information is correct. If all of the information is correct, proceed to [Step 10](#). If something needs to be changed, click **Previous** and make the necessary changes.
10. To save the ticket information to a USB device *instead* of emailing from the library, select the check box at the top of the screen (shown in [Figure 174](#) on page 311).
Note: The option to save the ticket to a USB device is only available if you connected a USB device to the library before you clicked **Send Log Set** to begin updating the ticket.
11. Click **Submit**. A progress screen indicates that the ticket request (with log information) is being sent. When completed, the AutoSupport Profiles screen displays. When Spectra Logic receives the request, the ticket is updated and an email response is sent to the user with a ticket number.

CHAPTER 12

Library Troubleshooting

This chapter describes troubleshooting steps you can take, as appropriate, to help resolve problems you might encounter while operating the library. Try these troubleshooting procedures *before* you open a support ticket with Spectra Logic Technical Support. If you are unable to resolve the problem yourself, open a support ticket (see [Opening a Support Ticket](#) on page 447).

Note: The library must be under warranty or have a valid service contract in order to qualify for support (see [Service Contract Extension](#) on page 468 to learn about service contracts).

Topic	
Troubleshooting Library Problems	page 315
Troubleshooting Library Initialization Issues	page 315
Troubleshooting BlueScale User Interface Issues	page 316
Troubleshooting MLM Issues	page 319
Troubleshooting Encryption Issues	page 320
Resolving Operational Issues	page 322
Using BlueScale Hardware Health Monitoring	page 324
Respond to HHM Notifications	page 324
View Hardware Health Monitoring (HHM) Data	page 328
Capturing Traces	page 330
Resetting the Library	page 333
Resetting Components	page 333
Reset the LCM or RCM	page 334
Reset a RIM	page 335
Reset the LCM or RCM	page 337
Testing the Robotics	page 337
Restoring the Library Configuration	page 340
Restore From an Auto Configuration Save File	page 341
Restore the Library Configuration Using a Saved Configuration	page 346
Restore the MLM and DLM Databases	page 348

TROUBLESHOOTING LIBRARY PROBLEMS

If you have a problem with your library, use the information in this section to obtain help with resolving the problem.

Check...	To...
System Messages	Review any System Messages that were posted by the library (see Check and Respond to Messages on page 146) and take any action described in the message(s).
Error Sense Codes	Look up the definition of an error sense code referenced in a system message using the <i>Spectra Tape Libraries SCSI Developer Guide</i> .
Library BlueScale Software Version	Confirm that your library is at the latest released version of BlueScale software (see Check the Library BlueScale Software Version on page 389). Some problems with library components may be fixed by updating the component firmware if the library is using a downlevel BlueScale version.
Technical Support Portal	<p>Find information about the most current version of BlueScale software and additional service and support tools. You can access the Technical Support portal at support.spectrallogic.com.</p> <p>Note: Accessing many of the tools available on the Technical Support portal requires creating a user account. See Accessing the Technical Support Portal on page 444 for instructions.</p> <ul style="list-style-type: none"> ▪ Check the options under the Documentation and Knowledge Base menus for additional troubleshooting information. ▪ Check the Service & Contracts menu to view information about the warranty and service options available for your library as well as the Spectra Certified Media warranty.

TROUBLESHOOTING LIBRARY INITIALIZATION ISSUES

This section provides information about potential library initialization issues that you may experience.

Issue	Resolution
Library hangs while gathering initialization tasks	The library gathers tasks at the beginning of the library initialization process, and displays this as its first task on the Library Initialization screen. If the library is unable to gather the required initialization tasks within a few minutes of powering on, contact Spectra Logic Technical Support for assistance (see Contacting Spectra Logic on page 7).
Library hangs during initialization	If the library cannot complete the initialization process, it generates system messages and enter maintenance mode. Contact Spectra Logic Technical Support for assistance (see Contacting Spectra Logic on page 7). Do not power off the library.

TROUBLESHOOTING BLUESCALE USER INTERFACE ISSUES

This section provides information about potential issues that you may experience while using the library's BlueScale user interface, either from the operator panel or through the web interface (RLC).

Issue	Resolution
BlueScale screens exhibit display problems	<p>Occasionally, the BlueScale interface may exhibit display problems (for example, one screen displays on top of another or there are multiple toolbars), either in the operator panel user interface or through the web interface.</p> <p>Click the refresh display button (🔄) on the status bar to refresh the screen.</p> <p> Important: If you have a keyboard connected to the LCM or if you are accessing the library through the BlueScale web interface, do not use the keyboard to refresh the screen (for example, by pressing F5). Doing so may cause unpredictable results.</p>
Cannot access the library using the BlueScale web interface (RLC)	<ul style="list-style-type: none"> ▪ Make sure that the library is connected to the network via an Ethernet cable connected to the left most Ethernet port on the LCM. The right-most Ethernet port on the LCM is a dedicated EtherLib port. (see Figure 9 on page 39). ▪ Make sure that the web server port is correctly configured for your environment (see Web Server Port on page 100). ▪ Make sure that an IP address is configured for the library (see Configure Network Settings on page 104). ▪ If SSL is enabled for the library, make sure that you enter the IP address using the form: https://[library IP address]. See Connecting to the library remotely using the BlueScale web interface on page 84 for additional information. ▪ Reset the LCM to make sure that the Ethernet port is not hung (see Reset the LCM or RCM on page 334).
Cannot change a configuration setting	<p>Before attempting to change configuration settings:</p> <ul style="list-style-type: none"> ▪ Recommended — Make sure that the drives in the partition are empty. ▪ Make sure that the host is not communicating with the library. ▪ Make sure that no background processes are running (for example, Media Auto Discovery, PreScan, or PostScan). If a background process is running, the library displays a message indicating what it is. <ul style="list-style-type: none"> ▪ If the background process is Media Auto Discovery, PreScan, or PostScan and you cannot wait for the process to complete, you can stop or pause the operation (Stop the Discovery Process on page 264 and Pause the PostScan Process on page 272). ▪ For all other background processes, wait until the process is completed and then retry the configuration change.

Issue	Resolution
Cannot create a new storage partition	<p>Make sure that you have:</p> <ul style="list-style-type: none"> ▪ An active SLS key to support multiple partitions entered in the Option Enablement panel of the System Settings screen (see Standard and upgraded options for the library on page 96). ▪ Unassigned licensed chambers available for use in the new partition. If necessary, modify an existing partition to make chambers available (see Modifying an Existing Partition on page 190), license additional chambers with a CoD capacity key (see Capacity-On-Demand (CoD) on page 470), or purchase a new frame. ▪ One or more drives available for use in the new partition. If necessary, modify an existing partition to make one or more drives available or install additional drives. ▪ Fewer than sixteen storage partitions configured. ▪ A maximum of six different exporting controllers can be used in a library. ▪ Make sure that no background processes are running (for example, Media Auto Discovery, PreScan, or PostScan). If a background process is running, the library displays a message indicating what it is. <ul style="list-style-type: none"> ▪ If the background process is Media Auto Discovery, PreScan, or PostScan and you cannot wait for the process to complete, you can stop or pause the operation (Stop the Discovery Process on page 264 and Pause the PostScan Process on page 272). ▪ For all other background processes, wait until the process is completed and then retry the partition creation.
Cannot import or export cartridges	<p>Make sure that no background processes are running (for example, Media Auto Discovery, PreScan, or PostScan). If a background process is running, the library displays a message indicating what it is.</p> <ul style="list-style-type: none"> ▪ If the background process is Media Auto Discovery, PreScan, or PostScan and you cannot wait for the process to complete, you can stop or pause the operation (Stop the Discovery Process on page 264 and Pause the PostScan Process on page 272). ▪ For all other background processes, wait until the process is completed and then retry the import or export operation.
Cannot log into the library	<p>Log into the library using the default superuser (su). See Configuring Library Users on page 90 for a list of the default user names and passwords.</p>
Forgot the user names or passwords	

Issue	Resolution
Cannot use a Global Spare drive to replace a malfunctioning drive in the partition	<ul style="list-style-type: none"> ▪ Make sure that a Global Spare drive is assigned to the partition (see Assign Global Spare Drives on page 173). ▪ Make sure that no background processes are running (for example, Media Auto Discovery, PreScan, or PostScan). If a background process is running, the library displays a message indicating what it is. <ul style="list-style-type: none"> ▪ If the background process is Media Auto Discovery, PreScan, or PostScan and you cannot wait for the process to complete, you can stop or pause the operation (Stop the Discovery Process on page 264 and Pause the PostScan Process on page 272). ▪ For all other background processes, wait until the process is completed and then retry activating the Global Spare.
Operator panel touch screen displays broken graphics or an error message	<ol style="list-style-type: none"> 1. Display the soft keyboard. 2. Change the keyboard to display the number keypad. 3. Depending on what is displayed on the screen, press and hold the specified number key for 10 seconds: <ul style="list-style-type: none"> ▪ 1 — Refresh the library's built-in web browser. Use this option if you see a message such as "Page cannot be displayed" or if graphics on the screen (for example, health icons) are not loading properly. ▪ 2 — Restarts the library's built-in web browser. ▪ 3 — Restarts the library's web server and the built-in web browser. Use this option if you see a message such as "Page not found."
System message states that the BlueScale Software Support key expired	A valid BlueScale Software Support key is required before you can update BlueScale software. Renew the key as described in Renewing the BlueScale Software Support Key on page 386 .
System message states that the library booted to the redundant partition	The library uses a secondary mirror of the operating system if it is unable to successfully start from the primary copy. Contact Spectra Logic Technical Support for assistance (see Contacting Spectra Logic on page 7).
Touch screen buttons and text fields are out of alignment	Recalibrate the touch screen (see Calibrating the Touch Screen on page 410).
USB device does not appear as a "save to" option	<ul style="list-style-type: none"> ▪ Make sure that you plug the USB device into the LCM or the operator panel, and allow time for the device to mount, before you select the option that saves data to the USB device. ▪ Reset the LCM to make sure that the USB port is not hung (see Reset the LCM or RCM on page 334). ▪ The library only recognizes FAT-formatted, not NTFS-formatted, USB devices. Try using a different USB device.

TROUBLESHOOTING MLM ISSUES

This section provides information about potential issues that you may experience while using MLM.

Issue	Cause	Resolution
An asterisk (*) appears next to the barcode on the MLM Details screen or an MLM report	The cartridge was exported from the library.	If you do not intend to reimport the cartridge, you can delete it from the MLM database (see Delete MLM Records From the Database on page 284).
An “x” appears next to a barcode on the Inventory screen	The cleaning cartridge is expired.	Export the expired cartridge or exchange it for a new one (see Export or Exchange Expired Cleaning Cartridges on page 213).
The library does not proactively discover new cartridges when they are imported	The discovery process (Media Auto Discovery or PreScan) cannot begin while the hosts are actively loading cartridges into or unloading cartridges from the drives. If you import cartridges during this time, the library posts a failure message stating that no drives are available to perform the discovery process.	Either wait until the library is idle before beginning the import or manually start the discovery process for imported cartridges when the library is idle. See Discover Cartridges Manually on page 262 for instructions.

TROUBLESHOOTING ENCRYPTION ISSUES

The information in this section may help resolve encryption-related problems.



Issue	Cause	Resolution
<p>Library can not access the Spectra SKLM or KMIP server</p>	<p>The Spectra SKLM of KMIP server's operating system firewall does not allow the library to access the server.</p>	<p>Create a firewall rule on the server to allow the library to access the server.</p> <p>Use the port setting that was assigned to the server during the BlueScale (library) portion of the server configuration.</p> <p>The default port setting for Spectra SKLM is 3801. See "Configure the Spectra SKLM Server" in the <i>Spectra Tape Libraries Encryption User Guide</i> to determine your port setting.</p> <p>The default port setting for KMIP is 5696. See "Configuring KMIP Encryption" in the <i>Spectra Tape Libraries Encryption User Guide</i> to determine your port setting.</p>
<p>System message states that "Load attempted while encryption is enabled, but no moniker or key list was sent to the DCM"</p>	<p>If a cartridge is left in a drive after the library loses power or you reset or power-cycle the library, the drive is not able to receive encryption monikers. This can also occur if a tape is left in a drive while the drive is reset or reseated.</p>	<p>Use the following steps to re-enable the encryption process:</p> <ol style="list-style-type: none"> 1. Move the cartridge out of the drive and return it to its storage location (see Exchange Magazines or Cartridges in a Partition on page 212). 2. Reset the drive (see Resetting a Drive on page 351).

Issue	Cause	Resolution
<p>System message states that a tape drive requires a specific moniker</p>	<p>The cartridge was encrypted using an encryption key that is not currently available on the library.</p> <p>Or, if you are using BlueScale Professional Edition, the required encryption key is available, but was not selected as one of the partition's decryption keys.</p>	<p>Depending on which BlueScale Encryption edition you are using, use the following steps to enable the cartridge to be read:</p> <p>BlueScale Standard Edition</p> <ol style="list-style-type: none"> 1. Log into the library as a superuser. 2. Log into the encryption feature. 3. Export and then delete the encryption key currently listed on the Encryption Configuration screen (see “Deleting an Encryption Key from the Library” in the <i>Spectra Tape Libraries Encryption User Guide</i>). 4. Import the required encryption key (see “Import the Required Key into the Library” in the <i>Spectra Tape Libraries Encryption User Guide</i>). 5. Select Configuration ...> Partitions. 6. Click Edit next to the partition containing the cartridge. 7. Navigate through the BlueScale partition wizard to the Encryption screen. 8. Select the encryption key to be associated with the partition. 9. Click Next to proceed to the Summary screen of the Partition Wizard, and click Save. <p>BlueScale Professional Edition</p> <ol style="list-style-type: none"> 1. Log into the library as a superuser. 2. Log into the encryption feature. 3. Make sure the encryption key is listed on the Encryption Configuration screen. If it is not listed, add the key to the library (see “Import the Required Key into the Library” in the <i>Spectra Tape Libraries Encryption User Guide</i>). 4. Select Configuration ...> Partitions. 5. Click Edit next to the partition containing the cartridge. 6. Navigate through the BlueScale partition wizard to the Encryption screen. 7. Select the required encryption key as either the primary encryption key or as a decryption key. <p>Note: A maximum of eight decryption keys can be assigned to one partition.</p> <ol style="list-style-type: none"> 8. Click Next to proceed to the Summary screen of the Partition Wizard, and click Save.

RESOLVING OPERATIONAL ISSUES

This section provides information about potential issues you may encounter while operating the library.

Issue	Cause	Resolution
One or more chambers marked as unusable	When the library is repeatedly unable to insert a magazine into a chamber, it marks the chamber as unusable and posts a system message.	<ol style="list-style-type: none"> 1. Open a support ticket describing the system message that was posted (see Opening a Support Ticket on page 447). 2. Continue using the library, keeping the following in mind: <ul style="list-style-type: none"> ▪ If the library has unassigned chambers, operation is not affected. However, if you create a new partition that uses the unassigned chambers, you are not able to load magazines into all of the chambers assigned to the partition. ▪ If all of the chambers in the library are assigned to partitions, the number of magazines that can be imported into the partitions is reduced.
Element addresses change after installing additional drives	Installing additional drives into a partially filled DBA, or removing drives from a DBA, may cause the library to reassign element addresses.	To avoid errors after adding a new drive, make sure that you reconfigure the element addresses your storage management software uses to access drives when you install a new drive (refer to your software documentation for instructions).
Magazine is in TAP after a power failure	If the library loses power while a TeraPack magazine is in a TAP, the library only identifies the magazine's presence in the TAP the next time media is imported or exported.	To recover the magazine, use the Import/Export TeraPack Magazines screen to initiate an import or export operation (see Chapter 7 – Importing and Exporting Cartridges , beginning on page 196 for instructions).
Magazine is left in transporter following a move	The library was unable to insert the magazine into its original chamber and no empty chambers are available. The library posts a system message and halts.	Contact Spectra Logic Technical Support for assistance (see Contacting Spectra Logic on page 7).
System message indicates that the robotics are blocked	A blockage is preventing the library from moving the robotics.	Contact Spectra Logic Technical Support for assistance (see Contacting Spectra Logic on page 7).

Issue	Cause	Resolution
<p>Cartridge left in a tape drive after a library power-cycle or reset</p> <p>If the drive is a Global Spare, see Cartridge left in a Global Spare tape drive after a library power-cycle or reset</p>	<p>If the library loses power during backup operations or you reset or power-cycle the library without first unloading all of the drives, cartridges may remain in the drives.</p>	<p> CAUTION: When the Unload Drives utility runs, cartridges are unloaded from all drives in the selected partition(s), even if they are active. This could cause backups to fail. Do not use the Unload Drives utility when file storage operations are actively running.</p> <ol style="list-style-type: none"> 1. From the toolbar menu, select Maintenance ...  Tools. The Maintenance Tools screen displays. 2. Select Utilities. The Utilities screen displays. 3. Click Show Advanced. The Advanced Utilities Confirmation screen displays. 4. Click Next. The Utilities screen refreshes to show a list of the advanced utilities. 5. Scroll down and select Unload Drives. 6. From the Select the partition or library drop-down list, select a partition or Total Library. 7. Click Run Utility. 8. A progress screen displays, all drives assigned to partitions in the full library or the selected partition are unloaded, and the cartridges are returned to their original slots or the first available slot if the original slot is not available. When the operation is complete, a Utility Results screen displays. <p>Note: This utility does not unload cartridges from Global Spare tape drives being used for PostScan. If there is a cartridge left in a Global Spare tape drive, see Cartridge left in a Global Spare tape drive after a library power-cycle or reset.</p>
<p>Cartridge left in a Global Spare tape drive after a library power-cycle or reset</p>	<p>If the library loses power or if you reset or power-cycle the library while the PostScan process is running, the cartridge being scanned remains in the drive. The library generates a message to notify you that the Global Spare contains a cartridge after it completes its initialization process.</p>	<p> CAUTION: Make sure the drive you are sparing is not actively running a backup or restore operation. This could cause backups to fail.</p> <p>Use the following steps to return the cartridge to its storage location:</p> <ol style="list-style-type: none"> 1. Examine the partition inventories to determine in which partition the cartridge belongs (see Viewing and Downloading the Cartridge Inventory on page 224). 2. Substitute the Global Spare tape drive containing the cartridge for another drive in the same partition (see Use the Global Spare Drive on page 353). 3. Move the cartridge out of the drive and return it to its storage location (see Moving Cartridges Within a Partition on page 231). 4. Return the drive back to Global Spare status. (see Undo the Global Spare Drive on page 356).

Issue	Cause	Resolution
Library has EtherLib, but EtherLib options do not display in Package Update	The EtherLib network is disconnected.	Navigate to Maintenance ... Tools and select EtherLib Status . If the status indicates that any of the targets are not connected, check the cabling between the components and then click Refresh .

USING BLUESCALE HARDWARE HEALTH MONITORING

Overview BlueScale Hardware Health Monitoring (HHM) tracks maintenance thresholds for key library components. When the library or one of its components reaches its maintenance threshold the HHM icon appears on the status bar. As with the system message icon, the color of the icon indicates the urgency of the notification.

When the HHM icon appears on the status bar, you can click the icon to view information about the notification and send a Hardware Health Monitor ticket to a contact person within your organization or to Spectra Logic Technical Support so they can review the logs and determine if any maintenance tasks are needed.

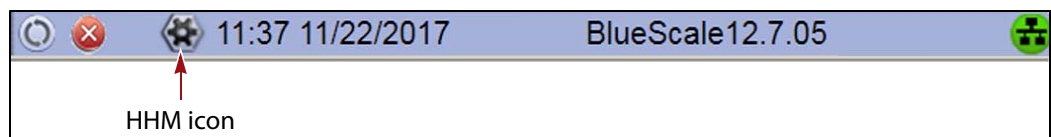

Figure 175 The HHM icon is located on the status bar.

- To send an AutoSupport log to a contact person, see [Respond to HHM Notifications](#), beginning on this page.
- To view a report showing the current HHM data, see [View Hardware Health Monitoring \(HHM\) Data](#) on page 328.

User Privilege Requirements Only a user with superuser or administrator privileges can respond to HHM notifications by creating an AutoSupport ticket and viewing HHM data.

Respond to HHM Notifications

Use the following steps to send the Hardware Health Monitoring notification and AutoSupport Log (ASL) file to the contact person in a predefined AutoSupport profile. You can also choose to send the ASL files to Spectra Logic Technical Support so they can review the logs and determine if any maintenance tasks are needed to prevent future problems.

Note: AutoSupport Log (ASL) information is only for troubleshooting purposes. This log information is separate from the data path and contains no customer data.

1. Log into the library as a user with superuser or administrator privileges.
2. If not already completed, configure the mail recipients who should receive AutoSupport information. Also configure one or more AutoSupport profiles.
 - **Mail recipients** — See [Configure Mail Users on page 106](#). At a minimum, configure Spectra Logic Technical Support as a mail recipient if you want the library to email AutoSupport ticket requests to Spectra Logic.
 - **AutoSupport profiles** — See [Configure AutoSupport Profiles on page 301](#). You can configure one of the mail recipients to receive critical alarm log sets automatically sent by the library.
3. Click the HHM icon on the status bar (see [Figure 175 on page 324](#)). The Hardware Health Monitoring screen displays.

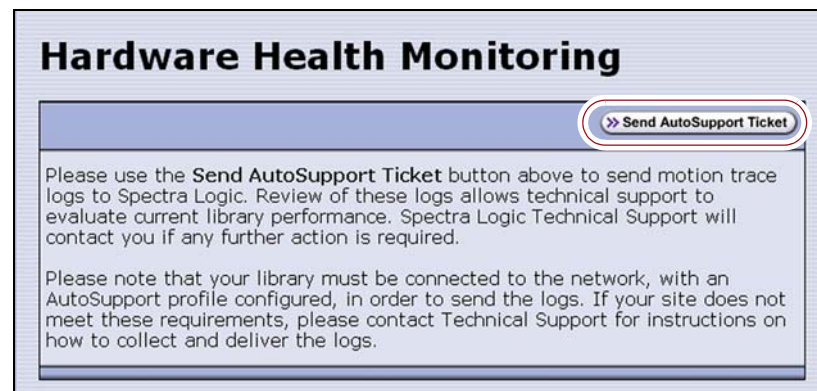

Figure 176 The Hardware Health Monitoring screen provides information about responding to the HHM notification.

4. If you want to save the AutoSupport ticket information to a USB device, insert the USB device into a USB port on the LCM (see [Using a USB Device on page 157](#)) or the operator panel and allow time for the device to mount.

Note: The option to save the ticket information to a USB device is only available if you connect a USB device to the library **before** you click **Send AutoSupport Ticket**.

- Click **Send AutoSupport Ticket**. The main AutoSupport screen displays.



Figure 177 Click **Send Log Set** to open a support ticket.

- Click **Send Log Set**. The Select Profile to Send Log Set screen displays.

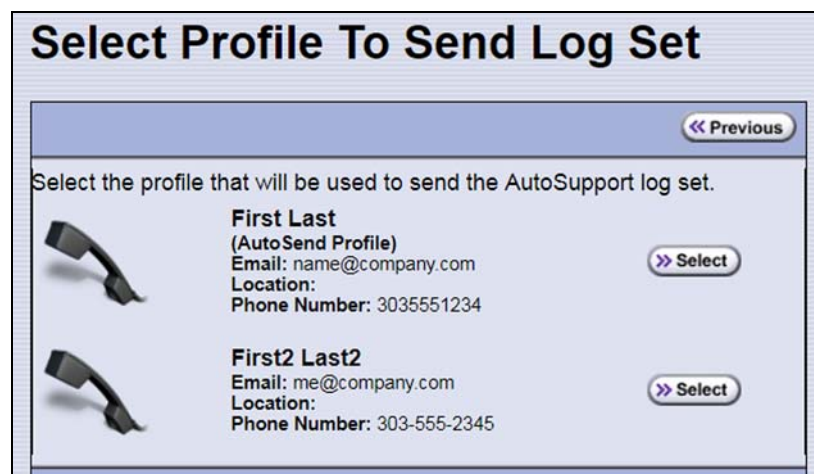

Figure 178 Select the AutoSupport profile to use for the support ticket.

- Click **Select** next to the profile for the main contact person for HHM issues. The Select Ticket Type screen displays.

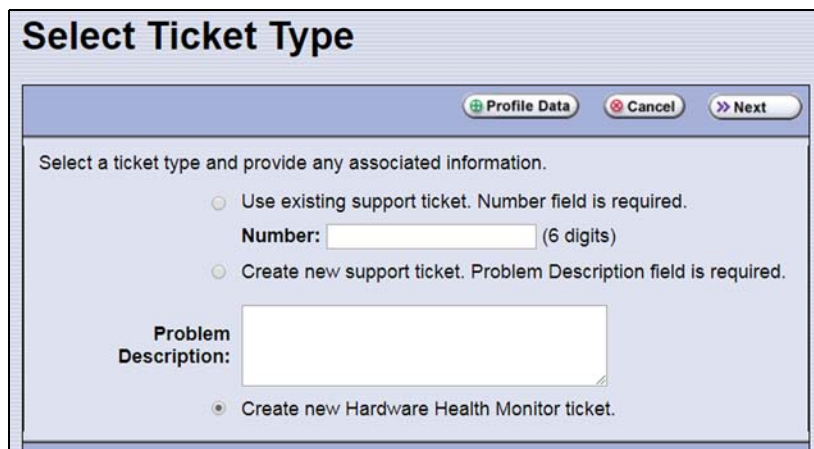

Figure 179 Enter a problem description on the Select Ticket Type screen.

The **Create new Hardware Health Monitor ticket** option is automatically selected. The options for entering an existing support ticket number and a problem description are not available.

8. If you do not need to make any changes to the contact person's information for this support ticket, skip to [Step 9 on page 327](#).

If you need to *temporarily* change the contact person's information for this ticket, click **Profile Data**. The Profile Summary screen displays (see [Figure 173 on page 310](#)). Make any necessary changes in the Profile Summary screen. Click **Use Settings** to save your changes and return to the Select Ticket Type screen.

9. Click **Next**. The Confirm and Submit Ticket screen displays.

Confirm and Submit Ticket

Save trouble ticket data to USB instead of mailing

A ticket will be opened for this request during Spectra Logic's regular business hours, which are 8 a.m. - 5 p.m. Monday through Friday, Mountain Time.

If this ticket is generated outside those hours, and you have a 24 hour support contract, place a call to Spectra Logic support now if this problem requires immediate attention.

The summary for profile FirstName1 LastName1 is outlined below. These settings will be used for the current trouble ticket only. To save these settings permanently, use the profile wizard.

Company Name: Spectra Logic Customer
Address: Boulder, CO
Address:
Site/Building Location:
Customer/Contract Number: 123456
Name: FirstName1 LastName1
Primary Phone: 303-555-5555
Alternate Phone:
Email Address: name1@company.com
Host Operating System:
Host Backup Software:
System Notes:
Mail To: name1@company.com

Problem Description: Hardware Health Monitor Triggered Events: Counter Type: General Maintenance Counter SubType: None Counter Value: 999999999 (hours) Reminder Type: Service Required Reminder Name: Service Required Reminder Message: Your library has not been serviced in over a year. Contact your service provider to schedule a library maintenance call. Current Threshold: 12960 Posted Date: 2008/04/08 13:13:50

Ticket Type: Hardware Health Monitor

Figure 180 The Confirm and Submit Ticket screen.

10. Verify that all information is correct.
 - To save the ticket information to a USB device instead of emailing it from the library, select the box at the top of the screen.

Note: The option to save the ticket information to a USB device is only available if you connected a USB device to a USB port on the LCM or the operator panel in [Step 4 on page 325](#).
 - If all of the information is correct, proceed to [Step 11](#).
 - If something needs to be changed, click **Previous** to return to the Select Ticket Type screen and make any necessary changes.
11. Click **Submit** to send the Hardware Health Monitor ticket to the selected recipient.

A progress screen indicates that the ticket request (and the ASL information) is being sent. When completed, the AutoSupport Profiles screen displays.
12. After any required tasks are complete, the threshold can be reset. The HHM icon disappears until the next threshold is reached.

View Hardware Health Monitoring (HHM) Data

The advanced utility called HHM: View Data generates a report showing the current status of the HHM counters. This information includes the following:

- Library serial number and name (if configured)
- Information about key library components monitored by HHM, including the type of reminder generated when the component reaches its maintenance threshold
- Robotics moves: Drive To Drive Moves, Drive To Slot Moves, Slot To Slot Moves, Slot To Drive Moves, TAP In Moves, and TAP Out Move.



Caution

In addition to the HHM: View Data utility, two additional HHM utilities configure the HHM counters and thresholds for the monitored components. **Do not** change the values for any counters or thresholds unless you are specifically instructed to do so by Spectra Logic Technical Support.

Use the following steps to view the current HHM data.

1. Log into the library as a user with superuser or administrator privileges.
2. From the toolbar menu, select **Maintenance**  **Tools**. The Maintenance Tools screen displays.
3. Select **Utilities**. The Utilities screen displays.
4. Click **Show Advanced**. The Advanced Utilities Confirmation screen displays.

5. Click **Next**. The Utilities screen refreshes to show a list of the advanced utilities.
6. Scroll through the list of advanced utilities and select **HHM: View Data**. The screen refreshes to show the details for the utility.



Figure 181 The HHM: View Data utility.

7. Click **Run Utility**.

After a brief delay, the Utility Results screen displays the current HHM data. Scroll as necessary to view all of the data.

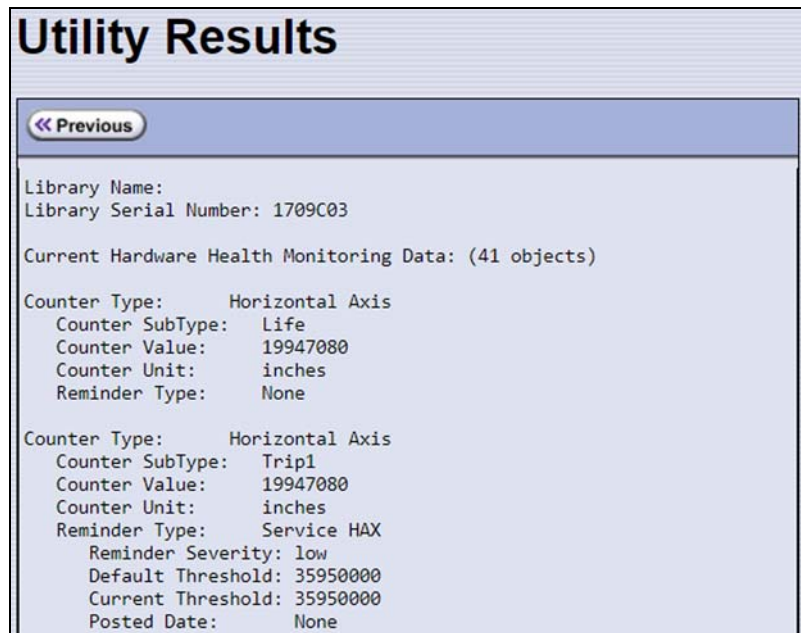

Figure 182 The HHM: View Data Utility Results screen.

8. Click **Previous** to return to the list of advanced utilities.

CAPTURING TRACES

Overview Spectra Logic uses traces to help diagnose problems with the library. You only need to capture traces when instructed to do so by Spectra Logic Technical Support. They tell you what type of trace you need to capture.

Emailing Trace Results If you plan to email trace results directly from the library, make sure that you set up the recipients as mail users (see [Configure Mail Users on page 106](#)).

If you are connected to the library using a web browser, you can also copy and paste the trace results into a text file and email it to Spectra Logic Technical Support if they request it.

Saving Trace Results to a USB Device If you plan to save trace results to a USB device, you must connect the USB device to the LCM or the operator panel and allow time for the device to mount **before** you select **Traces** on the Maintenance Tools screen (see [Connect a USB Device to the Library on page 158](#)). If a USB device is not connected, the USB option is not available. You can, however, still save trace results to the memory card in the LCM. You can also view the results without saving them.

User Privilege Requirements Only a user with superuser or administrator privileges can capture traces.

Procedure Use the following steps to capture the desired trace.

1. Log into the library as a user with superuser or administrator privileges.
2. From the toolbar menu, select **Maintenance ... Tools** to display the Maintenance Tools screen.



Figure 183 The Maintenance Tools screen.

3. If you want to save the traces to a USB device, connect the USB device to the LCM or the operator panel and allow time for the device to mount.
4. Select **Traces**. The System Traces screen displays with the trace options that were selected the last time the screen was viewed.

5. Select the type of trace that Spectra Logic Technical Support requested.

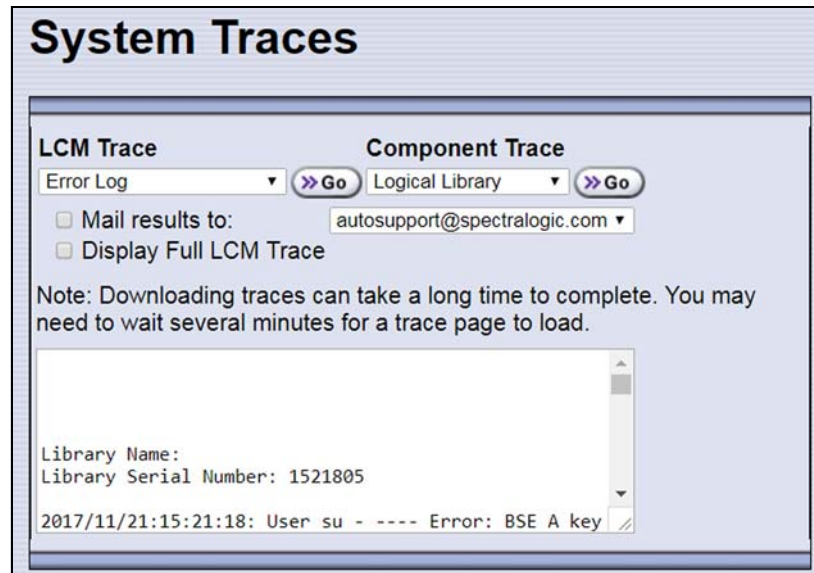

Figure 184 Select the traces you want to capture on the System Traces screen (Error Log trace results shown).

- **LCM Trace** — Captures a trace relating to a single aspect of operations related to the LCM.
- **Component Trace** — Captures a trace relating to the logical library or a single aspect of operations related to the robotics or a controller (RIM).

Note: The RIMs in the library are listed as F-QIPs.

6. Use the check boxes to select any combination of the options for saving the generated trace.

Option	Description
Mail results to	<p>Sends the trace report to a previously configured mail recipient. Use the drop-down list to select the recipient for the report file.</p> <p>To send the email with the attached trace file to someone who is not already listed as a library user, you must first configure that person as an email recipient (see Configure Mail Users on page 106).</p> <p>Note: Do not use the default <i>autosupport@spectralogic.com</i> email recipient. Spectra Logic does not save emailed traces unless they are specifically requested for troubleshooting.</p>
Save to USB	<p>Saves the report to the USB device. The results can then be viewed from any device that can read from USB.</p> <p>Note: This option is only available if you inserted a USB device in Step 3 on page 330.</p>

Option	Description
Display Full LCM Trace	Opens a new screen that shows the entire trace. Note: The Display Full LCM Trace check box only applies to selections made in the LCM Trace list, not selections made in the Component Trace list. If Display Full LCM Trace is selected when you are generating a component trace, the selection is ignored.

- Click **Go** next to either LCM Trace or Component Trace. The library retrieves the requested trace, which may take several minutes.

If you...	The trace results...
Did not select Display Full LCM Trace ,	Display in the scrolling box on the System Traces screen (see Figure 184 on page 331).
Selected Display Full LCM Trace ,	Display in the Trace Results screen. Click Previous to return to the System Traces screen. 

Figure 185 Select the Display Full LCM Trace option to view the entire LCM trace on the Full Trace screen (Error Log trace results shown).

- If you chose to save the file to a USB device or mail it, a message displays showing the filename for the trace file.

RESETTING THE LIBRARY

Many troubleshooting or error recovery operations only require resetting the LCM as described in [Reset the LCM or RCM on page 334](#). Because resetting the LCM does not affect communication with hosts, servers, and software, backups can continue while the LCM resets.

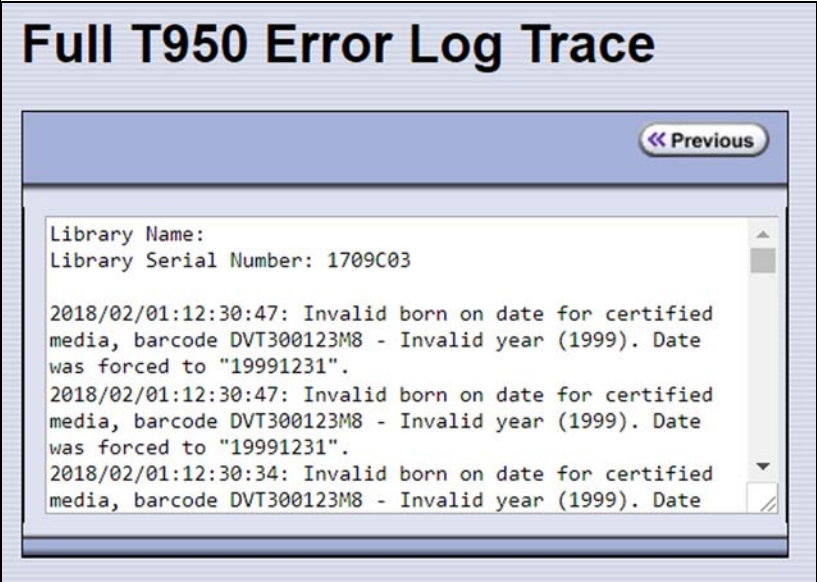
Performing some types of troubleshooting operations or recovering from some error conditions require you to reboot (power-cycle) the entire library. Power-cycling the library resets all of the components in the library.



Caution

Do not reset the library unless you are specifically instructed to do so. Trace data generated by the library may be lost when you reset the library or a component, making diagnosing problems difficult.

Note: Any drives that are not assigned to a partition generate system messages showing that the drive disappeared and then reappeared whenever the library is power-cycled.

Use the following steps if Spectra Logic Technical Support instructs you to reboot the entire library by power-cycling it.

1. If possible, pause PostScan if it is running (see [Pause the PostScan Process on page 272](#)). Any tapes currently being scanned are returned to their storage locations.
2. Discontinue all file storage operations to the library.
3. Power off the library (see [Power Off the Library on page 143](#)).
4. Wait at least 10 seconds.
5. Power on the library (see [Power On the Library on page 141](#)) and wait while the library performs its initialization process.
6. If a cartridge is left in a drive after the reset is complete, see [Resolving Operational Issues on page 322](#) for information about returning the cartridge to its storage location.

RESETTING COMPONENTS

If instructed to do so by Spectra Logic Technical Support or by error messages, you can reset certain library components as described in this section. See [Resetting the Library](#), above, if you need to reset the entire library.



Caution

Do not reset a component unless you are specifically instructed to do so. Trace data generated by the library or the component may be lost when you perform a reset, making diagnosing problems difficult.

Reset the LCM or RCM

To reset the LCM or RCM, insert the tip of a toothpick or other similar **non-conductive** object into the hole on the back of the LCM or RCM to press the reset button.

**Caution**

Do not use a metallic object to press the reset button. You may inadvertently cause an electrical short inside the module.

**Important**

Resetting the RCM resets the motion control for the robotics. Any move requests fail until the RCM completes its initialization.

**Important**

Resetting the LCM resets the operator panel and the web server. Any connections to the library through the BlueScale web interface are lost. Wait five minutes for the reset to complete and then reconnect. Backup operations are not affected.

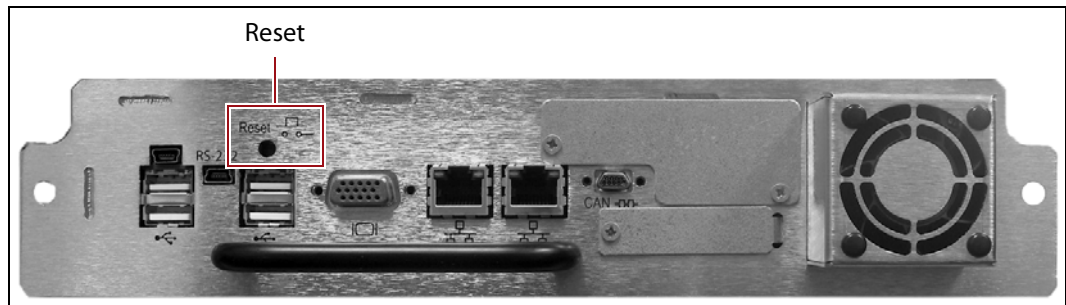

Figure 186 The reset button on the Spectra LS.

Reset a RIM

Hardware Reset

To perform a hardware reset of a RIM2, insert the tip of a toothpick or other similar **non-conductive** object into the hole in the back panel to press the Reset button.



Caution

Do not use a metallic object to press the reset button. You may inadvertently cause an electrical short inside the module.

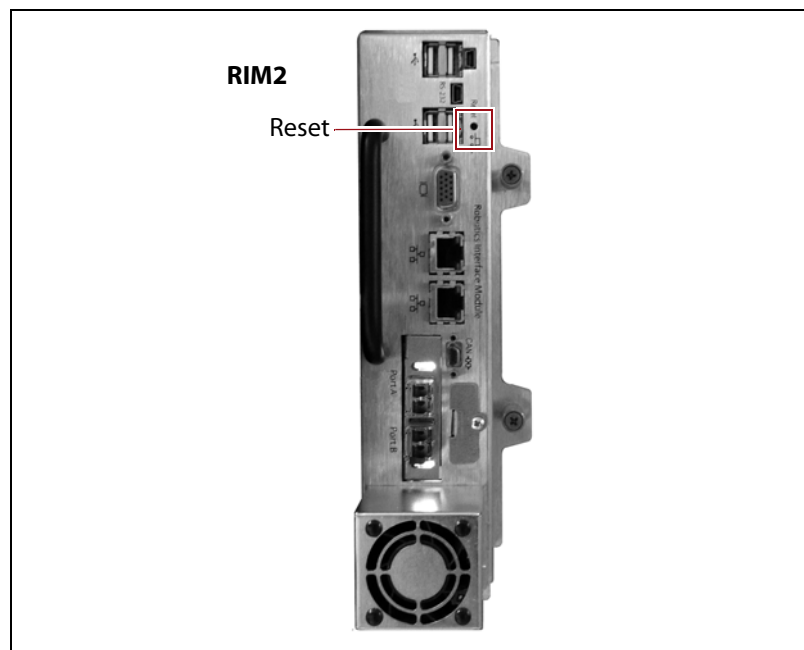



Figure 187 Location of the RIM2 hardware reset button.

BlueScale Software Reset

You can also reset the RIM2 through the BlueScale user interface.

1. Determine the BlueScale identifier for the controller you need to reset.
Note: RIMs are shown as F-QIPs in the BlueScale user interface and are identified according to their physical location in the library. See [RIM2 Identifiers on page 57](#) for information about identifiers.
2. Log into the library as a user with superuser or administrator privileges.
3. From the toolbar menu, select **Maintenance**  **Tools**. The Maintenance Tools screen displays.
4. Select **Utilities**. The Utilities screen displays.
5. Click **Show Advanced**. The Advanced Utilities Confirmation screen displays.

6. Click **Next**. The Utilities screen refreshes to show a list of the advanced utilities.
7. Scroll through the list of advanced utilities and select **Reset Controller**. The screen refreshes to show the details for the utility.



Figure 188 The Reset Controller utility for resetting a RIM.

8. Use the drop-down list to select the component identifier for the controller that you need to reset.
9. Click **Run Utility** to reset the selected controller.

When the reset is complete, the Utility Results screen displays, showing that the controller was reset.

Note: When the controller is reset, the library posts system messages that the F-QIP disappeared and reappeared.

10. The controller is ready for use.

Reset the Power Control Module

The main frame and each drive expansion frame has a PCM. To reset the over-current circuit that protects the power system in the event of a voltage surge, insert the tip of a toothpick or other similar **non-conductive** object into the hole on the back of the PCM to press the reset button.

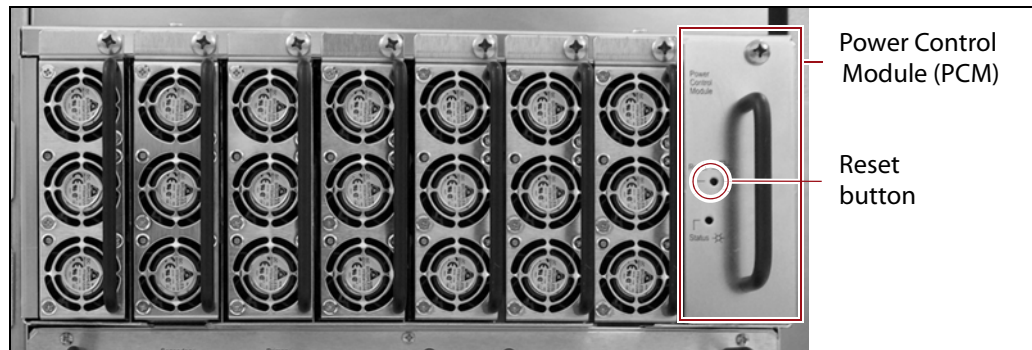

Figure 189 Power Control Module reset button.

TESTING THE ROBOTICS

Overview If you are experiencing problems that result in system messages indicating that there is a problem with the library’s robotics (for example, motion failures), Spectra Logic Technical Support may instruct you to perform basic motion tests of the robotics. You only need to perform this test if you are instructed to do so.

The Run All Motion Basic Tests feature described in this section performs the same series of tests on the robotics as the “Run All Motion Basic Tests” diagnostic accessed by selecting **Maintenance** ... **Diagnosics**. When the tests are started from the Robotics Status screen, they run in the background; you can continue to use the BlueScale interface to perform other tasks. When the tests are started from the Diagnostics screen, you must wait until the tests are complete before you can perform other tasks.

The library runs all of the tests, even if one or more of the tests fail. When all of the tests are complete, the library generates a system message that contains the status for all the tests.

Emailing Test Results If Spectra Logic Technical Support requests the results of the test, you can email the Robotic Motion trace to Spectra Logic Technical Support (see [Capturing Traces on page 330](#)).

User Privilege Requirements Only a user with superuser or administrator privileges can test the robotics.

Start the Tests

1. Log into the library as a user with superuser or administrator privileges.

2. If necessary, select **General** → **General Status** to display the library's General Status screen.
3. Click **Robotics** to display the Robotics Status screen.

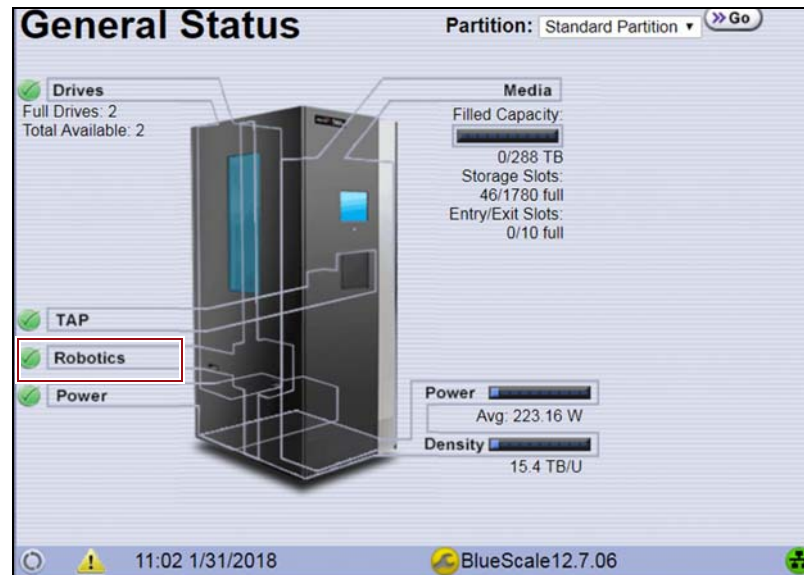

Figure 190 Click **Robotics** to display the Robotics Status screen.

4. Click **Start** on the Tools tab to start the Run All Motion Basic Tests.

Note: After the tests start, you can use the BlueScale interface to perform other tasks. You only need to return to this screen if you need to stop the tests.

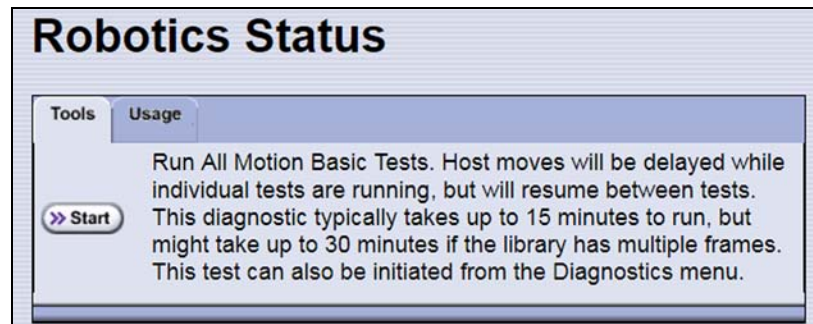

Figure 191 Start the Run All Motion Basic Tests diagnostic.

If you need to end the tests before they are completed, return to the Robotics Status screen and click **Stop**. If you cancel the tests, the library completes the current test, halts further testing, and redisplay the Robotics Status screen.

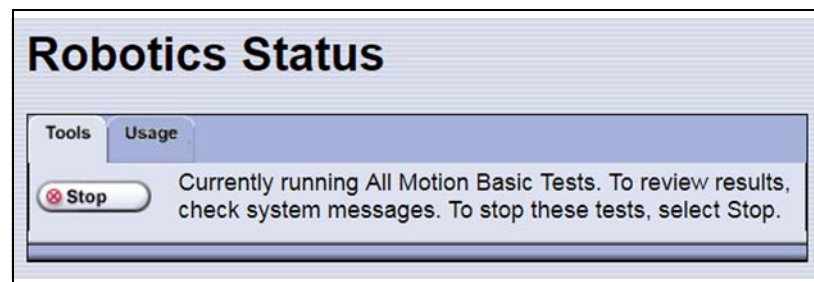

Figure 192 Click **Stop** to terminate the diagnostic.

5. When the last test completes, the library posts a system message showing the diagnostic results. View the system messages to see the test results (see [Check and Respond to Messages](#) on page 146).

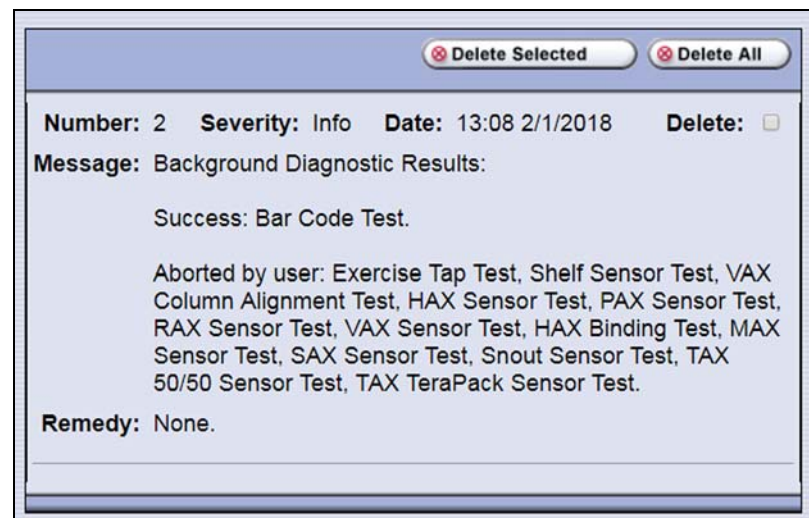

Figure 193 A system message shows the results of the Run All Motion Basic Tests diagnostics (tests aborted by user).

RESTORING THE LIBRARY CONFIGURATION

Overview If you have valid backups of the library's configuration and the MLM database saved on a USB device or sent as an email attachment, you can use them to restore the library in the event of a disaster. You can also use these backups to restore the library if problems require you to replace the LCM or the memory card in the LCM. See [Backing Up the Library Configuration on page 135](#) for information about backing up the library configuration.

- Notes:**
- All backup files of the library configuration include any BlueScale encryption keys that were stored in the library at the time the file was created.
 - The backup of the MLM database also contains the DLM database.

To restore the...	Using the...	See...
Library configuration, the MLM and DLM databases, and the BlueScale encryption keys stored in the library	Auto Configuration Save file,	Restore From an Auto Configuration Save File on page 341.
Library configuration and the BlueScale encryption keys stored in the library	Saved configuration file,	Restore the Library Configuration Using a Saved Configuration on page 346.
MLM and DLM databases	MLM database backup file,	Restore the MLM and DLM Databases on page 348.
BlueScale encryption keys	Exported key file,	See the <i>Spectra Tape Libraries Encryption User Guide</i> .

User Privilege Requirements Only a user with superuser or administrator privileges can restore the library configuration and the MLM and DLM databases. To restore BlueScale encryption keys, the user must also be logged in as an encryption user. See [Understanding User Groups and Security on page 90](#) and the *Spectra Tape Libraries Encryption User Guide* for information.

Restore From an Auto Configuration Save File

The advanced utility called “Restore Library Configuration from Auto Save” uses the configuration backup file that the library generates automatically to restore the library configuration, the MLM and DLM databases, and any BlueScale encryption keys that were stored in the library when the backup file was created (see [Use Automatic Backup of the Library Configuration on page 136](#)).

**Important**

Before restoring your system using the automatically generated backup file, check the time stamp included in the file name to ensure that you have the most current file.

**Important**

The library does not automatically save a backup when you make changes to any of the library configuration settings other than those for partitions. Any changes made since the last backup need to be entered manually.

The library automatically generates a configuration backup file whenever any of the following events occurs:

- When you make a change to a partition, the library immediately generates a configuration backup file and saves it to the memory card in the LCM. If you configured the option to email the backup file, the backup file is sent as an email attachment to the specified recipient (see [Enable Email for the Auto Configuration Save File on page 108](#)).
- Changes to any of the library configuration settings other than those for partitions are automatically saved in the configuration backup file that the library creates each week. The timing for this backup is based on the first time the automatic backup file is generated.
- If you cannot restore from the configuration backup file on the LCM and you have manually generated backups of the library configuration and the MLM database that are more current than the available automatically generated configuration backup file that is saved elsewhere, you may want to use those backups instead of the automatically generated configuration backup file (see [Restore the Library Configuration Using a Saved Configuration on page 346](#) and [Restore the MLM and DLM Databases on page 348](#)).

Restore the Library

Use the following steps to restore the library configuration, the MLM and DLM databases, and BlueScale encryption keys that were stored in the library, using an automatically generated configuration backup file.

Note: If you cannot use the automatically generated configuration backup file stored in the library, locate an Auto Configuration Save file that was saved to a USB device or sent as an email attachment.



Important The library cycles power after restoring the previous configuration.

1. If you plan to restore using the zip file containing the automatically generated configuration backup file that was sent as an email attachment, use the following instructions to copy it to a USB device; otherwise, skip to [Step 2](#).
 - a. Create a folder called `\autocfgsave` on a USB device.
 - b. Copy the zip file you received in the email to the `\autocfgsave` folder on the USB device.
 - c. Connect the USB device to a USB port on the LCM or the operator panel and allow time for the device to mount before continuing.
2. Log into the library as a user with superuser or administrator privileges.
3. From the toolbar menu, select **Maintenance**  **Tools**. The Maintenance Tools screen displays.
4. Select **Utilities**. The Utilities screen displays.
5. Click **Show Advanced**. The Advanced Utilities Confirmation screen displays.
6. Click **Next**. The Utilities screen refreshes to show a list of the advanced utilities.

7. Scroll through the list of advanced utilities and select **Restore Library Configuration from Auto Save**. The screen refreshes to show the details for the utility.



Figure 194 The Restore Library Configuration from Auto Save utility.

8. Use the **Select a configuration time stamp** drop-down list to select the configuration backup file you want to use. The automatically generated configuration backup files are named `<date-time>cfg.zip`, where `<date-time>` is the time stamp for when the file was created.

Unless you replace the LCM or its memory card, the first file listed is the zipped configuration backup file stored on the LCM memory card.

Note: If available, the zipped configuration backup file stored on the LCM memory card usually contains the most recently saved library configuration information, as well as the MLM and DLM databases. Check the time stamp in the filename to determine whether any manually generated backup file you have is more recent.

9. Click **Run Utility**.



Important

Before the library is restored using the configuration backup file on a USB device, the library's current configuration is saved to the USB device with a time stamp indicating when the file was created. The library is then restored using the selected configuration backup file on the USB device.

The USB device now contains one additional Auto Configuration Save file.

After a brief delay, the Utility Results screen appears, showing that the configuration was restored. The library then performs a power-cycle reset.

10. Once the library begins its power-on sequence, remove the USB device if necessary.

**Important**

If you do not remove the USB device, the library power-on sequence fails. If the library fails to boot, power off the library as described in [Power Off the Library on page 143](#). Once the library is powered off, remove the USB device and power on the library as described in [Power On the Library on page 141](#).

Restore Other Configuration Changes

The library does not immediately generate a configuration backup file when you make changes to any of the library configuration settings other than those for partitions. If you made any changes to the library configuration after the automatically generated configuration backup file you used to restore the library was generated, you need to repeat those changes after completing the restore.

- If you have a manual backup of the library configuration that is more current than the automatically generated configuration backup file you used, you can use it to restore the updated configuration (see [Restore the Library Configuration Using a Saved Configuration on page 346](#)).
- If you do not have a manual backup available, you need to restore the following changes manually:
 - If you made configuration changes after the creation date of the automatically generated configuration backup file you used, you need to use the options in the System Setup screen to repeat those changes after the restore is complete.
 - If you entered activation keys after the creation date of the automatically generated configuration backup file you used, you need to use the Option Enablement pane of the System Configuration screen to re-enter those keys (see [Enter Activation Keys on page 97](#)).

Update the Library Inventory

When you restore the configuration, any magazines that were imported into a partition after the configuration backup file you used was generated are not recognized as belonging to the partition. Instead, the library notifies you that there are unused magazines in the free pool.

Use the following instructions to update the library inventory to reflect the correct number of magazines assigned to the partition.

1. Log in as a user with superuser or administrator privileges.

2. From the toolbar menu, select **Configuration**  **Partitions**. The Shared Library Services screen displays.
3. Click **Edit** for the partition to which the unassigned magazines should belong.
4. Click **Next** to advance through the partition configuration screens until you reach the Chambers and Drives screen.

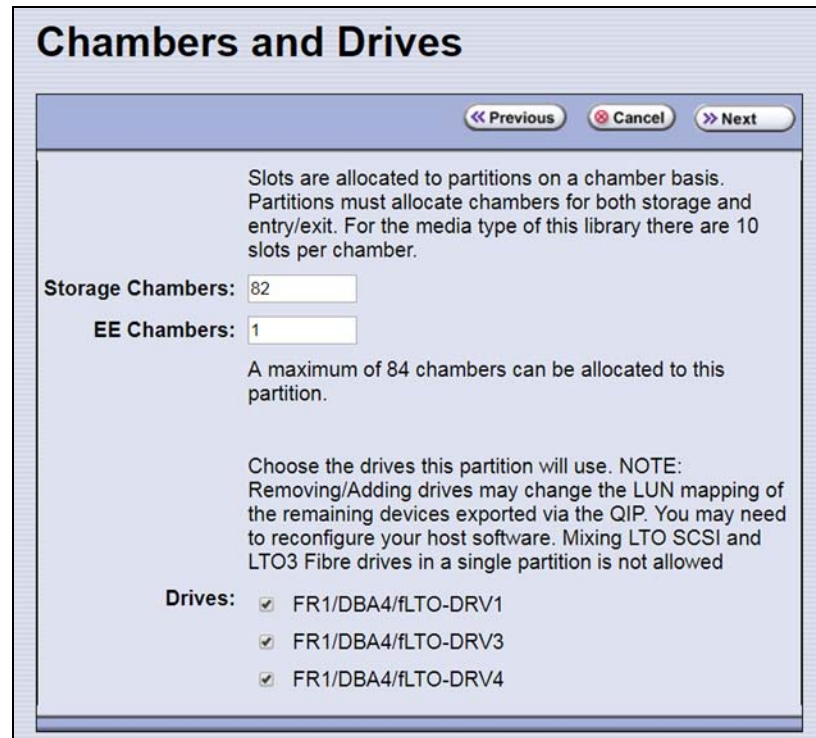

Figure 195 The Chambers and Drives screen.

5. Decrease the number of storage chambers assigned to the partition by the number of missing magazines.
6. Click **Next** to advance through the remainder of the screens without making any additional changes until you reach the Save Library Configuration screen.
7. Click **Save**. The Share Library Services screen redisplay.
8. Repeat [Step 2 on page 345](#) through [Step 6](#), this time increasing the number of storage chambers assigned to the partition to the original number. The magazines in the free pool are reassigned to the partition.



Important

If the library has multiple partitions and you imported magazines into all of the partitions after the configuration backup file you used to restore the library was generated, the magazines can potentially end up in the wrong partition. Carefully examine the cartridge inventory for each partition. Export any wrongly assigned magazines and reimport them into the correct partition.

9. Review the information on the screen and confirm that all settings are correct for this partition's configuration.
 - If the configuration information is correct, proceed to [Step 10](#).
 - If the configuration information is not correct:
 - Click **Cancel** and configure the partition again from the beginning.

— OR —

 - Click **Previous** to move backward through the configuration screens until you reach the settings that need correction. Make any necessary corrections, then click **Next** to move forward through the screens and return to the Save Partition screen.
10. Click **Save**. The library requires several minutes to store the configuration information, after which the Shared Library Services screen redisplay.

Restore the Library Configuration Using a Saved Configuration

Use the following steps if you want to restore the library from a configuration backup file that was generated manually, as described in [Use Manual Backup of the Library Configuration on page 136](#).

Note: The manually-generated configuration backup files do not include the MLM and DLM databases. If you also need to restore the MLM and DLM databases, you must use a separately generated backup of the MLM database (see [Restore the MLM and DLM Databases on page 348](#)).

1. Log into the library as a user with superuser or administrator privileges.
2. From the toolbar menu, select **Maintenance**  **Tools**. The Maintenance Tools screen displays.
3. Select **Utilities**. The Utilities screen displays.
4. Click **Show Advanced**. The Advanced Utilities Confirmation screen displays.
5. Click **Next**. The Utilities screen refreshes to show a list of the advanced utilities.

6. Scroll through the list of advanced utilities and select one of the following, as applicable for your situation. The screen refreshes to show the details for the selected restore utility.

Note: The Advanced Utilities screen lists the utilities in alphabetical order. The following table lists the utilities in most-frequently-used order.

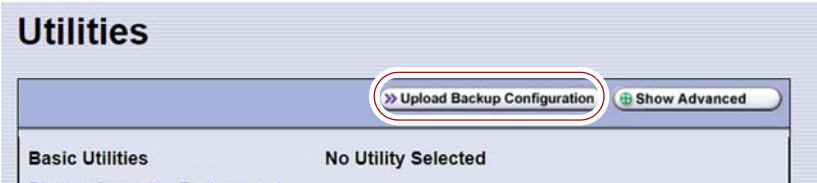
Use this Restore Option...	To...
Restore Library Configuration from Auto Save	Restore using an automatically generated configuration backup file that is stored on a USB device or LCM memory card (see Restore From an Auto Configuration Save File on page 341). Note: The automatically generated configuration backup file contains the library configuration, as well as the MLM and DLM databases.
Restore Library Configuration from USB	Restore a library configuration file previously stored on a USB device. Note: Before starting this procedure, insert the USB device into a USB port on the LCM or the operator panel and allow time for the device to mount.
Upload Backup Configuration	Upload a configuration backup file to a temporary location in the library from a computer that has network access to the library. Note: Upload Backup Configuration is only available when you access the library through the BlueScale web interface. <ol style="list-style-type: none"> 1. Click Upload Backup Configuration at the top of the screen.  <ol style="list-style-type: none"> 2. When the upload is complete, you must then run the Restore Library Configuration from Uploaded File utility to restore the library configuration.
Restore Library Configuration from Uploaded File	Complete the restore process after using Upload Backup Configuration to upload a saved configuration file from a computer. Note: This option is used in conjunction with Upload Backup Configuration , which must be run first.

7. Click **Run Utility**.



Important

Before the library is restored using a saved configuration file on the USB device, the current configuration is saved to the USB device with a time stamp indicating when the file was created. The library is then restored using the selected auto saved configuration. The USB device now contains one additional configuration file.

After a brief delay, the Utility Results screen appears, showing that the configuration file was uploaded and/or the configuration restored. The library then performs a power-cycle reset.

8. Once the library begins its power-on sequence, remove the USB device if necessary.



Important

If you do not remove the USB device, the library power-on sequence fails. If the library fails to boot, power off the library as described in [Power Off the Library on page 143](#). Once the library is powered off, remove the USB device and power on the library as described in [Power On the Library on page 141](#).

9. If you imported magazines into empty chambers in a partition's storage pool after you generated the backup configuration file, see [Restore Other Configuration Changes on page 344](#).
10. If necessary, restore the MLM and DLM databases as described in [Restore the MLM and DLM Databases on page 348](#).

Restore the MLM and DLM Databases

Use the following steps to restore the MLM database from a previously saved backup that was created using the Save MLM Database utility (see [Back Up the MLM and DLM Databases on page 282](#)).



Caution

The Restore MLM Database from USB utility overwrites the existing MLM and DLM databases with the versions previously saved on the USB device.

- Notes:**
- Restoring the MLM database also restores the DLM database.
 - You can also restore the MLM and DLM databases using an automatically generated library configuration backup file (see [Restore From an Auto Configuration Save File on page 341](#)).

1. Use your storage management software to stop all backup or restore operations on the library.



Important

Restoring the MLM and DLM databases requires the library to be idle.

2. If you plan to restore using an MLM database backup file that was sent as an email attachment, use the following instructions to copy the file to a USB device; otherwise, skip to [Step 5](#).
 - a. Create a folder called `SavedMLMDB` at the root of a USB device.
 - b. Copy the `xlminfo<date-time>.db` or `cminfo_<date-time>.zdt` file to the `SavedMLMDB` folder on the USB device.
3. Log into the library as a user with superuser or administrator privileges.
4. Stop any PreScan or PostScan operations that are currently running (see [Stop the Discovery Process on page 264](#) and [Pause the PostScan Process on page 272](#)).

5. Plug the USB device containing the MLM database backup file into a USB port on the LCM or the operator panel and allow time for the device to mount before continuing.
6. From the toolbar menu, select **Maintenance**  **Tools**. The Maintenance Tools screen displays.
7. Select **Utilities**. The Utilities screen displays.
8. Click **Show Advanced**. The Advanced Utilities Confirmation screen displays.
9. Click **Next**. The Utilities screen refreshes to show a list of the advanced utilities.
10. Scroll down and select **Restore MLM Database from USB**. The screen refreshes to show the details for the utility.

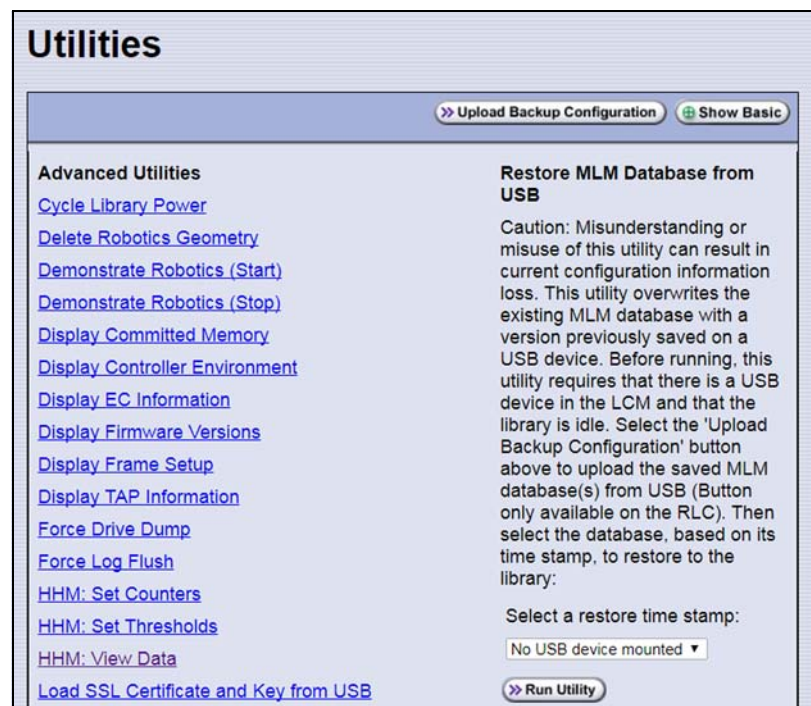



Figure 196 Select the Restore MLM Database from USB utility.

11. Use the **Select a restore time stamp** drop-down list to select the `xlminfo<date-time>.db` or `cminfo_<date-time>.zdt` file containing the MLM database backup you want to use for the restore.
12. Click **Run Utility**.

After a brief delay, the Utility Results screen displays, showing that the database was restored.

Note: After an MLM database restore, the **Discover Media** button on the Media Lifecycle Management Tools screen (**Maintenance**  **Media Lifecycle Management**) may be active even if all cartridges have been discovered.

CHAPTER 13

Drive Troubleshooting

This chapter describes procedures for dealing with the most common problems encountered with the library's drives. Try these troubleshooting procedures *before* you open a support ticket with Spectra Logic Technical Support. If you are unable to resolve the problem yourself, open a support ticket (see [Opening a Support Ticket on page 447](#)). For additional troubleshooting information, refer to the drive documentation (see [LTO Ultrium Tape Drives on page 20](#) and [TS11xx Technology Drives on page 20](#)).

Note: The library must be under warranty or have a valid service contract in order to qualify for support (see [Service Contract Extension on page 468](#) to learn about service contracts).

Topic	
Resetting a Drive	page 351
Using a Global Spare Drive	page 352
Use the Global Spare Drive	page 353
Undo the Global Spare Drive	page 356
Retrieving a Drive Trace or Drive Dump File	page 357
Use the Drive Traces Button	page 357
Use the IBM Tape Diagnostic Tool (ITDT) to Retrieve a Drive Dump	page 359
Use the BlueScale Retrieve Drive Dump Utility	page 360
Troubleshooting Drives	page 362
Identify the Problem	page 362
Interpret the Detailed Drive Information	page 366
Using DLM to Test a Drive	page 379
Requirements for Using the Wizard	page 379
Run the DLM Drive Health Verification Wizard	page 381

RESETTING A DRIVE

Overview You may occasionally need to reset a drive as part of a firmware upgrade or for troubleshooting.

Important

Drives can be reset using the Reset button on the Drives screen or using the Power Drive On/Off utility. This utility should **ONLY** be run on a drive that is not assigned to a partition. **Do not** use the advanced Power Drive on/off utility to reset a drive that is assigned to a partition. Running this utility on a drive assigned to a partition disables the host interface.

User Privilege Requirements Only a user with superuser or administrator privileges can use the BlueScale software to reset a drive.

Perform the Reset The following steps describe how to reset a drive using the **Reset** button on the Drives screen.

1. Determine the BlueScale identifier for the drive you want to reset.

Note: Drives are identified according to their physical location in the library. For example, FR1/DBA2/DRV4 refers to the upper right drive in DBA2 of frame 1. See [Drive Identifiers on page 57](#) for information about identifiers.

2. Log into the library as a user with superuser or administrator privileges.
3. Select **Configuration**  **DLM** (or **Drives**) to display the Drives screen.

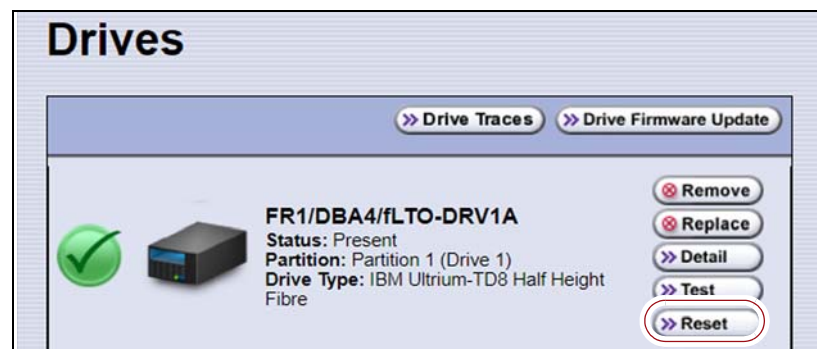

Figure 197 Click **Reset** on the Drives screen.

4. Identify the drive that needs to be reset and click **Reset**. The library power cycles the drive.

When the drive completes its POST and becomes ready, a status screen displays, showing that the drive was reset.

Note: When the drive resets, the library posts system messages that the drive disappeared and reappeared.

5. The drive is ready for use.

USING A GLOBAL SPARE DRIVE

Overview The Global Spare option lets you remotely replace a failed drive using a drive that is already installed in the library. Using a Global Spare allows you to continue your backup operations and replace the failed drive the next time you are physically present at the library.

Usage Requirements Before you can use the Global Spare option, the following requirements must be met.

- One or more Global Spare drives must already be configured in the partition where the failed drive is located (see [Assign Global Spare Drives on page 173](#)).



Important

The drives that are configured as Global Spares must be connected to the same Fibre Channel arbitrated loop or fabric (SAN) as the drives they replace. If they are not connected to the SAN, they are not accessible to the application software.

After the Global Spare is activated, you may need to reconfigure your switch to access the spare drive.

- The failed drive must be idle, with no pending backup or restore operations. Backups to the other drives in the partition can continue.

Note: You cannot use a Global Spare drive to replace a failed drive while the library is actively running the Drive Firmware Update wizard in the partition.

Cartridge Inventory If the failed drive contains a cartridge when it is replaced by the Global Spare, that cartridge is removed from the partition's inventory. If you are able to remove the cartridge from the failed drive after you remove it from the library, reimport the cartridge (see [Importing into a Storage or Cleaning Partition](#)).

PostScan Requirements If a partition is configured to use either FullScan or QuickScan using Global Spares, keep in mind that the PostScan process "owns" the Global Spare drive it is using until it processes all of the cartridges in the PostScan queue for the partition. As a result, a Global Spare drive that is being used for PostScan is not available for use as a spare.

If all of the Global Spare drives assigned to the partition are in use by the MLM PostScan process, you must pause PostScan to make a Global Spare drive available, as described in [Pause the PostScan Process on page 272](#).

Storage Management Software Guidelines Keep in mind the following storage management software guidelines when using a Global Spare.

- **Backup Exec™ software running on a Windows server** — After sparing or unsparing a drive, you must restart the Backup Exec Device and Media Service for the software to function properly with the spared drive.
- **General guidelines** — In a few rare cases, your backup may fail if a cartridge is loaded into any of the other drives in the partition at the same time that the library is in the process of activating a Global Spare drive for use (as described in this section). Most applications retry the backup operation, but some fail it. If your backup operation fails, wait for the library to complete the Global Spare activation and retry the backup.

User Privilege Requirements Only a user with superuser or administrator privileges can activate or reclaim a Global Spare drive.

Use the Global Spare Drive

Follow these steps to use a Global Spare drive as a temporary replacement for a failed drive.

1. If necessary, use your storage management software to stop any attempts to read from or write to the failed drive. Refer to your storage management software documentation for instructions.
2. Log into the library as a user with superuser or administrator privileges.
3. From the toolbar menu, select **Configuration**  **Partitions** to display the Shared Library Services screen.



Figure 198 Click **Global Spare** to begin the process of replacing a partition drive with a Global Spare drive.

4. Click **Global Spare** for the partition that contains the failed drive to display the Global Spare Usage screen.

Note: The **Global Spare** button is not present if one or more drives are not configured as Global Spares for the partition (see [Assign Global Spare Drives on page 173](#)).

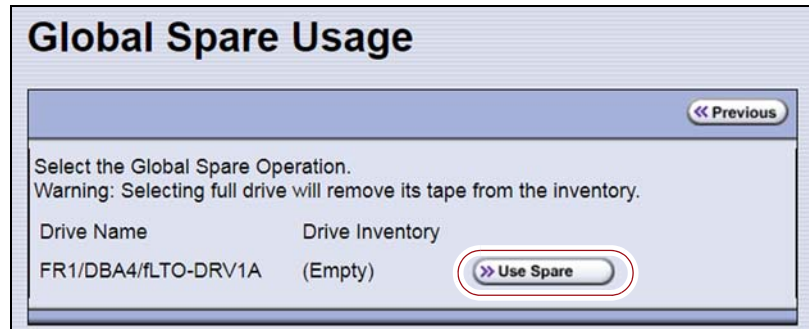

Figure 199 Click **Use Spare** for the drive you want to replace.

5. Click **Use Spare** next to the drive for which you want to substitute an available Global Spare drive. Wait for the library to complete the sparing operation.
 - Notes:**
 - When you select the drive to replace, the BlueScale software disables the selected drive and configures an available Global Spare drive to report the same WWN and serial number as the drive it is replacing. The failed drive can then be removed and replaced the next time you are physically at the library.
 - If you have more than one available Global Spare drive, the library automatically selects a drive in no particular order.

- If desired, select **Configuration** → **DLM** (or **Drives**) to view the Drives screen. The drive icons on the screen change to indicate the failed drive and the Global Spare that replaced it.

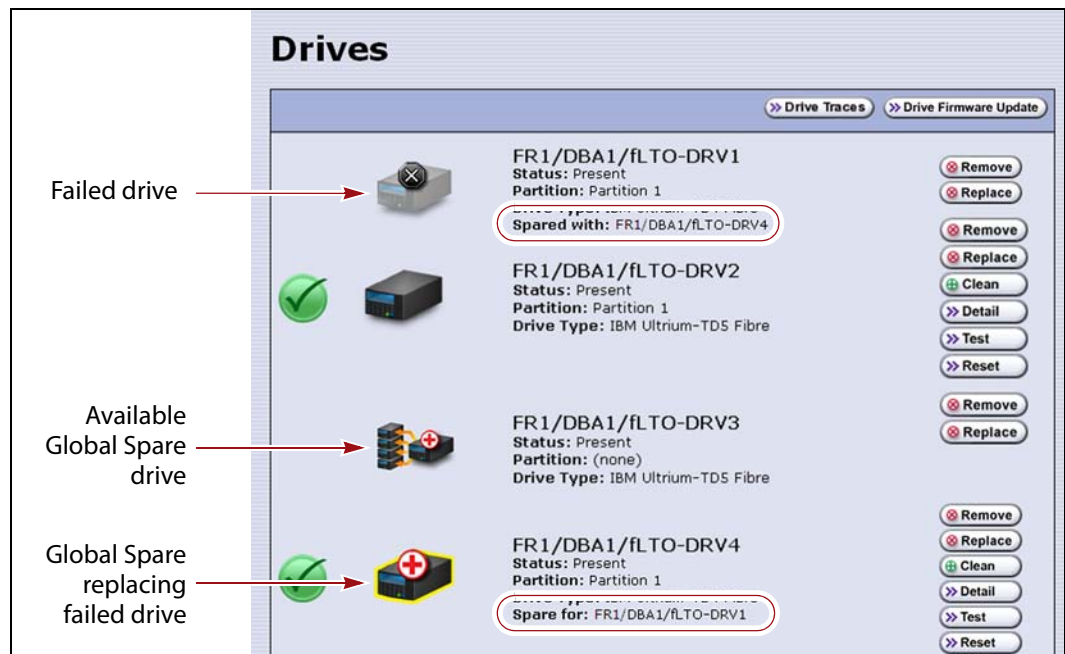

Figure 200 Check the Drives screen to confirm that the failed drive was replaced by a Global Spare drive.

- If necessary, use your storage management software to bring the Global Spare drive that replaced the failed drive online. Refer to your storage management software documentation for instructions.

Important

Replace the failed drive as soon as possible and reconfigure the spare drive to return it to a Global Spare configuration.

Note: If your storage management software cannot access the Global Spare drive, confirm that the drive is properly connected to the same SAN as the failed drive. You may also need to reconfigure the Fibre Channel switch.

Undo the Global Spare Drive

After you physically replace the failed drive (see [Replace a Drive on page 443](#)), use the following steps to begin using the replacement drive and return the Global Spare to the pool of available spare drives.

1. Log into the library as a user with superuser or administrator privileges.
2. Use your storage management software to prepare the Global Spare drive. Refer to your storage management software documentation for information.
 - a. Stop all storage management software activity to the Global Spare drive that replaced the failed drive.
 - b. If necessary, use your storage management software to eject the cartridge from the drive and return it to its slot.
 - c. Take the Global Spare drive offline.
3. When the Global Spare drive is empty and offline, select **Configuration**  **Partitions** on the toolbar menu to display the Shared Library Services screen.
4. Click **Global Spare** for the partition that contained the failed drive to display the Global Spare Usage screen.



Figure 201 Click **Undo Spare** to begin using the replacement drive you installed.

5. Click **Undo Spare** next to the drive you physically replaced.

The BlueScale software stops substituting the Global Spare for the drive it replaced and reconfigures the replacement drive back into the partition. The Global Spare is then available to be used again, as needed.
6. Use your storage management software to bring the newly installed drive online and resume backup operations. Refer to your storage management software documentation for instructions.

RETRIEVING A DRIVE TRACE OR DRIVE DUMP FILE

Spectra Logic uses drive traces and drive dumps to help diagnose problems with a drive. A drive trace is a set of logs collected by the library to help diagnose drive errors. A drive dump is a file generated by the drive when it encounters an error state. You only need to retrieve a drive trace or drive dump when instructed to do so by Spectra Logic Technical Support.

There are three tools for collecting drive traces and dumps. The best tool to use depends on the type of file requested and the ability to download and install ITDT.

- To retrieve a drive trace from LTO drives, [Use the Drive Traces Button](#).
- To retrieve a drive dump, if possible, [Use the IBM Tape Diagnostic Tool \(ITDT\) to Retrieve a Drive Dump on page 359](#).
- To retrieve a drive dump when you cannot use ITDT, [Use the BlueScale Retrieve Drive Dump Utility on page 360](#).

Use the Drive Traces Button

Drive traces for LTO drives can be generated and retrieved using the Drive Traces button on the Drives screen.

Note: The Drive Traces button is not supported for TS11xx technology drives.

Before You Begin

Before you begin generating a drive trace using the Drive Traces button, make sure you fulfill the following prerequisites.

Emailing Results If you plan to email the drive trace file directly from the library, make sure that you set up the intended email recipient as a mail user (see [Configure Mail Users on page 106](#)).

Saving Results to a USB Device If you plan to save the drive trace file to a USB device, you must connect the USB device to one of the USB ports on the LCM or the operator panel and allow time for the device to mount before you click **Drive Traces** (see [Using a USB Device on page 157](#)).

Note: If a USB device is not connected to the library, the option to save the drive trace file to a USB device is not available. You can, however, still email the trace file or download the file.

User Privilege Requirements Only a user with superuser or administrator privileges can use the BlueScale software to retrieve a drive trace file.

Generate the Trace

1. Log into the library as a user with superuser or administrator privileges.
2. Select **Configuration** > **DLM** (or **Drives**) to display the Drives screen.

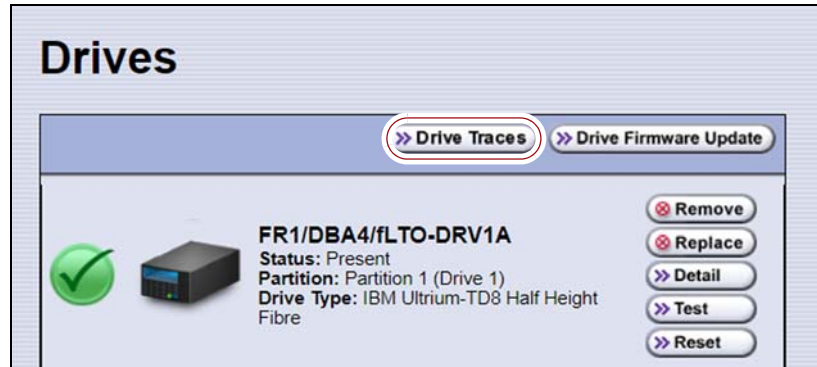

Figure 202 Click **Drive Traces** on the Drives screen.

3. Click **Drive Traces**. The Generate Drive Traces screen displays.

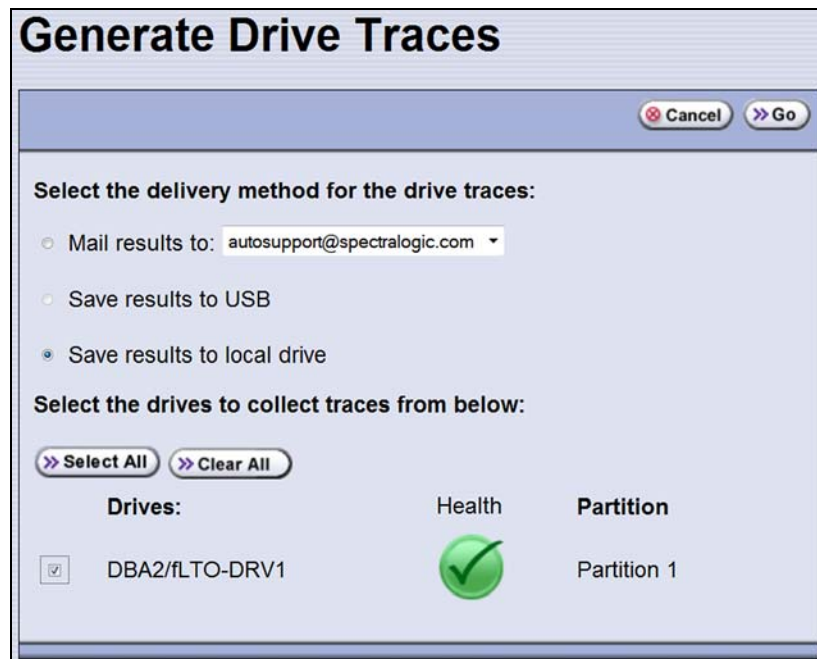

Figure 203 The Generate Drive Traces screen.

4. Select what you want to do with the drive trace file.

Option	Description
Mail results to	Sends the drive trace file to a previously configured email recipient. Use the drop-down list to select the recipient for the trace file. Only previously configured email recipients are listed. To send the email with the attached trace file to someone who is not listed, exit the utility, configure that person as an email recipient (see Configure Mail Users on page 106), and then run the utility again. Note: Do not use the default <i>autosupport@spectralogic.com</i> email recipient. Spectra Logic does not save emailed drive trace files unless they are specifically requested for troubleshooting.
Save results to USB	Saves the drive trace file to the USB device connected to the LCM. Note: This option is only available if you connected a USB device to one of the USB ports on the LCM before clicking Drive Traces .
Save results to local drive	Downloads the drive trace file to your local computer. Use your web browser's download features to save the file. Note: This option is only available if you are accessing the library through the BlueScale web interface.

5. Select the drives from which you want to generate traces. The drive trace file contains a subdirectory for each drive.
6. Click **Go**. The wizard generates the traces and saves or sends the drive trace file as selected.

Use the IBM Tape Diagnostic Tool (ITDT) to Retrieve a Drive Dump

Download ITDT and its related documentation directly from IBM's Fix Central website. For information about navigating IBM's website and downloading the version of ITDT that is appropriate for your operating system, log on to the portal (see [Accessing the Technical Support Portal on page 444](#)), open the Knowledge Base, and search for KBA-01768, *Downloading and installing ITDT (IBM Tape Diagnostic Tool)*.



Important

Use the latest version of ITDT to gather a drive dump from the latest generation of drives.

1. Log into IBM's Fix Central website at <http://www.ibm.com/support/fixcentral> using your individual IBM ID.
2. Select the following options:
 - **Product Group** = System Storage
 - **Select from System Storage** = Tape systems
 - **Select from Tape Systems** = Tape drivers and software
 - **Select from Tape drivers and software** = IBM Tape Diagnostic Tool (ITDT)
 - **Platform** = Select your operating system from the drop-down list and click **Continue**.

3. On the next page, select the version of ITDT that you want to download. If desired, you can select multiple versions.
Note: If you are unsure which version to select, click Show Fix Details to see additional information.
4. Click **Continue**. Choose one of the following methods to download the selected ITDT installation files:
 - **Download using your browser (HTTP)**
 - **Download using bulk FTP**
 - **Download using Download Director**
5. Download and read the ITDT documentation for assistance in using and setting up the program.
6. Refer to the ITDT documentation for information about using ITDT to retrieve drive dump files. Contact Spectra Logic Technical Support if you need assistance (see [Contacting Spectra Logic on page 7](#)).

Use the BlueScale Retrieve Drive Dump Utility

If for some reason you cannot install and use ITDT in your environment, use the BlueScale Retrieve Drive Dump utility to collect the dump file from a drive.

Note: The Retrieve Drive Dump Utility is not supported for TS11xx technology drives.

Before You Begin

Before you begin the utility, make sure you fulfill the following prerequisites.

Insert USB Device This utility saves the drive dump file to a USB device connected to the LCM or the operator panel. You must plug the USB device into one of the USB ports on the LCM or the operator panel and allow time for the device to mount before you access the Utilities screen (see [Using a USB Device on page 157](#)).

User Privilege Requirements Only a user with superuser or administrator privileges can use the BlueScale software to retrieve a drive dump file.

Run the Utility

1. Determine the BlueScale identifier for the drive from which you want to retrieve the dump file.

Note: Drives are identified according to their physical location in the library. For example: FR1/DBA2/DRV4 refers to the upper right drive in DBA2 of frame 1. Refer to [Drive Identifiers on page 57](#) for information about identifiers.

2. Log into the library as a user with superuser or administrator privileges.
3. From the toolbar menu, select **Maintenance**  **Tools**. The Maintenance Tools screen displays.
4. Select **Utilities**. The Utilities screen displays.
5. Click **Show Advanced**. The Advanced Utilities Confirmation screen displays.
6. Click **Next**. The Utilities screen refreshes to show a list of the advanced utilities.
7. Scroll through the list of advanced utilities and select **Retrieve Drive Dump**. The screen refreshes to show the details for the utility.



Figure 204 The Retrieve Drive Dump utility.

8. Select any combination of the check boxes at the top of the screen to choose where to send the utility results text.

Note: The check boxes indicate where to send the utility results text (pass or fail), not where to send the drive dump file. The drive dump file is always saved to the USB device. Do not send the utility results to the default *autosupport@spectrallogic.com* email recipient.
9. Use the drop-down list to select the drive from which you want to retrieve the dump.

10. Click **Run Utility** to retrieve the dump file from the selected drive.



Important

Do not use the drive from which you are retrieving the dump file for any other purpose while the utility runs.

When the dump is saved, the Utility Results screen displays, showing that the utility ran successfully.

TROUBLESHOOTING DRIVES

The following sections provide information about troubleshooting drive problems.

Identify the Problem

1. When you encounter problems with drive operation while using the library's BlueScale user interface, begin troubleshooting by checking the following:

Check...	To...
System messages	Review any system messages that were posted by the library (see Check and Respond to Messages on page 146) and take any action described in the message(s).
Error sense codes	Look up the definition of an error sense code referenced in a system message using the <i>Spectra Tape Libraries SCSI Developer Guide</i> .
Drive documentation	Find detailed troubleshooting information for the drive. See Additional Publications on page 19 for information about obtaining drive documentation.
Technical Support Portal	<p>Find information about the most current version of BlueScale software and additional service and support tools. You can access the Technical Support portal at support.spectralogic.com.</p> <p>Note: Accessing many of the tools available on the Technical Support portal requires creating a user account. See Accessing the Technical Support Portal on page 444 for instructions.</p> <ul style="list-style-type: none"> ▪ Check the options under the Documentation and Knowledge Base menus for additional troubleshooting information. ▪ Check the Service & Contracts menu to view information about the warranty and service options available for your library as well as the Spectra Certified Media warranty.

2. Display the Drive Details screen for the drive you suspect is having problems and review the information about the drive (see [View Drive Status Information on page 153](#)). Use the following table and the information in [Interpret the Detailed Drive Information on page 365](#) to determine how to proceed.

Detail Field	Description
POST Status	Indicates whether the drive successfully completed its power-on self-tests (POST). When a drive is power-cycled or reset, it automatically runs self-diagnostic tests (POST), which check the drive's memory and sensors, performs motor and servo tests, and tests the data channels, to make sure that the drive is functioning within normal parameters.
Cleaning Status	Indicates whether the drive requires cleaning (see Cleaning a Drive on page 412).
LED Status	Corresponds to the status LED on the drive. See Interpreting the Status LED Information on page 366 for detailed information.
Display Character or Display Message	Corresponds to the single-character display (SCD) on an LTO drive or the display message (MCD) on a TS11xx technology drive. See Interpreting the SCD and MCD Codes , beginning on page 366 for detailed information.
Cartridge Status	Indicates whether a cartridge is currently loaded in the drive, tape motion, and other information related to reading and writing data.

3. If you successfully operated the storage management software and library in the past, but are now experiencing problems reading and writing data, check the following:

Check this...	If...
Write-protect switch setting	You are having trouble writing data to a cartridge. Make sure that the cartridge is write-enabled (see Preparing Cartridges for Use on page 197) before importing it into the library.
Cartridge age	A tape cartridge was in use for a long time or if it was used frequently, try using a new cartridge.
Drive cleaning	The drive indicates that a cleaning is required. Follow the instructions in Cleaning a Drive on page 412 to clean the drive. Note: If the storage partition is associated with a cleaning partition and the cleaning partition contains a usable cleaning cartridge, drives are automatically cleaned whenever necessary.

4. If you experience problems accessing the drives in the library from the storage management software on the host, check the following:

Check...	To...
Interface connections	<p>Make sure that the Fibre Channel connections to the drives are secure.</p> <p> Important: After you power on the library and the Fibre Channel arbitrated loop or fabric completes its initialization, avoid disconnecting the Fibre Channel drives from the network. If you need to disconnect a drive from the network, use the utility provided with your switch or hub to bypass the affected ports before breaking the connection. The bypass sets the port to a non-participating state on the network. After you reconnect the drive to the library, use the utility to return the port to a participating state.</p>
Software installation	<p>Make sure that your host application is installed and configured correctly (refer to your software documentation). Pay special attention to steps that describe how to configure the software for use with the drive(s).</p>
Drive addressing	<p>Make sure that the drive address configured in the host application is the same one you specified when you configured the partition containing the drive (see Creating a Storage Partition on page 169).</p>
Host and software requirements	<p>Determine whether a device driver is required. Some operating environments require you to install device drivers before the application software can correctly communicate with the drives. When you update the drive firmware, you may also need to update the device driver for the drive. See Updating Drive Device Drivers on page 441 for instructions.</p>

Interpret the Detailed Drive Information

The Drive Details screen includes information about the drive and drive sled firmware versions, the location-based Spectra serial number, and the manufacturer's serial number. It also shows additional detailed status information, including the state of the status LED and the single-character display (SCD) for an LTO drive or the display message (MCD) for a TS11xx technology drive. See [View Drive Status Information on page 153](#) for information about accessing this screen.

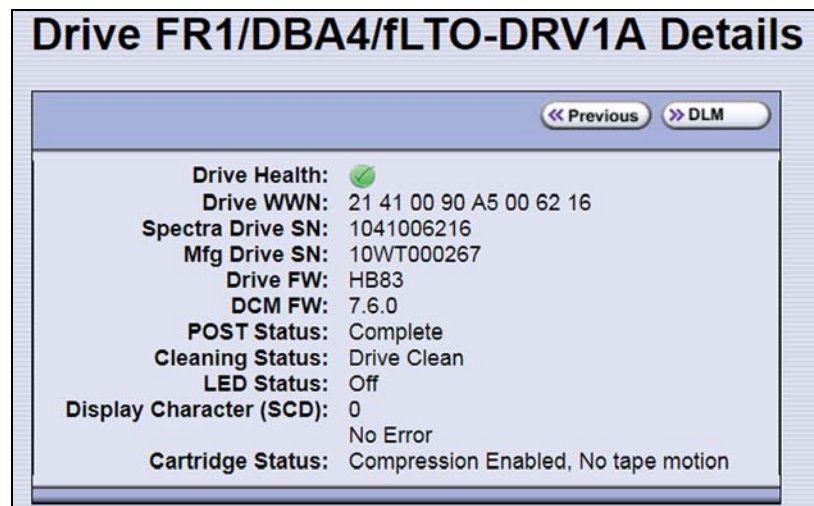

Figure 205 Use the information on the Drive Details screen to help troubleshoot drive problems.

The following sections describe how to use information on the Drive Details screen to help troubleshoot drive problems.

Responding to the Drive Cleaning Notification

Whenever a tape is loaded or unloaded, the read/write heads are physically cleaned by a brush located within the drive. However, after reading and writing a large amount of data (the exact amount varies by drive type and generation) or if read or write errors occur, the drive requests to be cleaned with a cleaning cartridge. The request is made by sending a Tape Alert message to the host, and displaying a **C** on the SCD for an LTO drive or **CLEAN*** on the MCD for a TS11xx technology drive. The notification is also posted to the library's Drive Details screen ([Figure 205 on page 365](#)) and the DLM drive health icon for the drive changes to yellow (see [Using the Drive Health Icons on page 291](#) for additional information).

If needed, clean the drive as described in [Cleaning a Drive on page 412](#). Use only a certified cleaning cartridge. To order cleaning cartridges, see [Media and Media Accessories on page 466](#).

Interpreting the Status LED Information

The Drive Details screen shows the state of the drive's status LED. The LED states are the same for all generations of drives. Refer to the tape drive documentation about interpreting the LED (see [LTO Ultrium Tape Drives on page 20](#) or [TS11xx Technology Drives on page 20](#)).

- Notes:**
- The LED status information shown on the Drive Details screen always indicates that the LED is off. If you need to determine the state of the LED, use the IBM Tape Diagnostic Tool (ITDT). Download and install the software as described in [Use the IBM Tape Diagnostic Tool \(ITDT\) to Retrieve a Drive Dump on page 359](#).
 - Make sure you install ITDT on a computer that is connected to the same SAN as the drives in the library.
 - For TS11xx technology drives, use the MCD to determine the status of the drive (see [Interpreting the SCD and MCD Codes](#)).

Contact Spectra Logic Technical Support if you need assistance (see [Contacting Spectra Logic on page 7](#)).

Interpreting the SCD and MCD Codes

Overview The Drive Details screen displays the state of the single-character display (SCD) on LTO drives (see [LTO SCD Codes on page 368](#)) or the display message (MCD) on TS11xx technology drives (see [TS11xx Technology MCD Codes on page 374](#)).

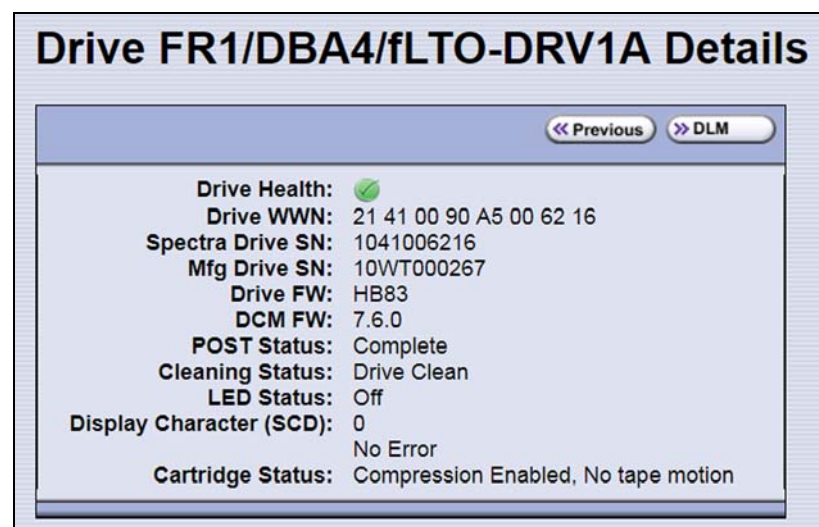

Figure 206 An LTO drive's SCD information on the Drive Details screen.

Permanent Errors If the drive detects a permanent error and displays an SCD or MCD error code other than zero (0), it automatically performs a drive dump. If you force a drive dump, the existing drive dump is overwritten and data is lost. You might also lose the dump data if you turn off power to the drive. See [Retrieving a Drive Trace or Drive Dump File on page 357](#) for information about retrieving the trace data or dump from the drive.

- Notes:**
- Some of the solutions listed in the following table include testing the drive. See [Using DLM to Test a Drive on page 379](#) for instructions.
 - In some cases, additional tests using ITDT are required. Download and install the software as described in [Use the IBM Tape Diagnostic Tool \(ITDT\) to Retrieve a Drive Dump on page 359](#). Refer to the ITDT documentation for information about using this utility. Contact Spectra Logic Technical Support if you need assistance (see [Contacting Spectra Logic on page 7](#)).

Multiple Errors If multiple errors occur, the code with highest priority (lowest number) displays first. Once corrected, the code with the next highest priority displays, until none remain.

Note: The drive may need to be reset in order to clear the error code.

WORM Media LTO and TS11xx technology drives support using WORM media. To learn more about WORM media, see [WORM Media on page 492](#).



The following conditions cause WORM media errors to occur:





- Information in the servo manufacturer's word on the tape must match information from the cartridge MAM. If it does not match, the drive's SCD displays error code **7**.
- Inserting a WORM tape cartridge into a drive that is not compatible with WORM media causes the cartridge to be treated as an unsupported medium. The drive's SCD displays error code **7**.



LTO SCD Codes

SCD Code Descriptions for LTO Drives The following table shows the SCD codes and, where applicable the associated DLM Drive Health icon for LTO drives. See the table on [page 292](#) for a description of what the Drive Health icons indicate. For TS11xx technology MCD codes, see [TS11xx Technology MCD Codes on page 374](#).



Note: The single-character display does not use the characters B, D, G, I, O and Z to prevent misinterpretation as the characters 8, 0, 6, 2, and 1.







Code	DLM Health Icon	Cause and Solution
0		No error occurred. No action is required. The power was cycled or diagnostics finished with no errors.
1		Cooling problem. The recommended operating temperature was exceeded. Perform one or more of the following: <ul style="list-style-type: none"> ▪ Make sure that the cooling fan is rotating and is quiet. ▪ Remove any blockage that prevents air from flowing freely through the drive. ▪ Make sure that the operating temperature and airflow is within the specified range (refer to the tape drive documentation for these specifications). If the operating temperature is within the specified range and the problem persists, contact Spectra Logic Technical Support (see Contacting Spectra Logic on page 7). Note: The error code clears when you reset or power cycle the drive or when you place it in maintenance mode.
2		Power problem. The externally supplied power is approaching the specified voltage limits (the drive is still operating) or is outside the specified voltage limits (the drive is not operating). If the problem is only exhibited by one drive in the library: <ul style="list-style-type: none"> ▪ Make sure that the library's power connector is properly seated. ▪ If the problem persists, contact Spectra Logic Technical Support (see Contacting Spectra Logic on page 7). Note: The error code clears when you reset or power cycle the drive or when you place it in maintenance mode. If the problem is exhibited by multiple drives in the library: The power throughout the library needs to be checked. Contact Spectra Logic Technical Support for assistance (see Contacting Spectra Logic on page 7).

Code	DLM Health Icon	Cause and Solution
3		<p>Firmware problem.</p> <p> Important: Do not force a dump; one already exists.</p> <p>The drive determined that a firmware error occurred. Perform the following:</p> <ol style="list-style-type: none"> 1. If possible, use ITDT to collect the existing drive dump (see Use the IBM Tape Diagnostic Tool (ITDT) to Retrieve a Drive Dump on page 359). If you cannot use ITDT, use the BlueScale Retrieve Drive Dump utility (see Use the BlueScale Retrieve Drive Dump Utility on page 360). 2. Reset the drive (see Resetting a Drive on page 351), then retry the operation that produced the error. 3. If the problem persists, contact Spectra Logic Technical Support and send the drive dump to them, if requested (see Contacting Spectra Logic on page 7). <p>Note: The error code clears when you reset or power cycle the drive or when you place it in maintenance mode.</p>
4		<p>Firmware or drive problem.</p> <p> Important: Do not force a dump; one already exists.</p> <p>A firmware or drive hardware failure occurred. Perform the following:</p> <ol style="list-style-type: none"> 1. If possible, use ITDT to collect the existing drive dump (see Use the IBM Tape Diagnostic Tool (ITDT) to Retrieve a Drive Dump on page 359). If you cannot use ITDT, use the BlueScale Retrieve Drive Dump utility (see Use the BlueScale Retrieve Drive Dump Utility on page 360). 2. Reset the drive (see Resetting a Drive on page 351), then retry the operation that produced the error. 3. If the problem persists, contact Spectra Logic Technical Support and send the drive dump to them, if requested (see Contacting Spectra Logic on page 7). <p>Note: The error code clears when you reset or power cycle the drive or when you place it in maintenance mode.</p>

Code	DLM Health Icon	Cause and Solution
5		<p>Drive hardware problem.</p> <p> Do not force a dump; one already exists.</p> <p>The drive determined that a tape path or read/write error occurred. To prevent damage to the drive or tape cartridge, the drive does not allow you to insert a cartridge if the current cartridge was successfully ejected. Perform the following:</p> <ol style="list-style-type: none"> 1. If possible, use ITDT to collect the existing drive dump (see Use the IBM Tape Diagnostic Tool (ITDT) to Retrieve a Drive Dump on page 359). If you cannot use ITDT, use the BlueScale Retrieve Drive Dump utility (see Use the BlueScale Retrieve Drive Dump Utility on page 360). 2. Reset the drive (see Resetting a Drive on page 351), then retry the operation that produced the error. 3. If the problem persists, contact Spectra Logic Technical Support and send the drive dump to them, if requested (see Contacting Spectra Logic on page 7). <p>Note: The error code clears when you reset or power cycle the drive or when you place it in maintenance mode.</p>
6		<p>Drive or media error.</p> <p>See Chapter 9 – Configuring and Using Media Lifecycle Management, beginning on page 243 for information about using MLM to determine the health of the cartridge. See Chapter 10 – Using Drive Lifecycle Management, beginning on page 288 for information about using DLM to determine the health of the drive.</p> <p>The drive determined that an error occurred, but it cannot isolate the cause. Ensure the tape cartridge is the correct media type:</p> <ul style="list-style-type: none"> ▪ See LTO Read/Write Compatibility on page 491 for information about which media is compatible with each LTO drive generation. ▪ Drive does not accept an expired cleaning cartridge. ▪ Drive does not accept a WORM cartridge when running diagnostic tests in Maintenance Mode. ▪ Drive does not write over existing data sets on a WORM cartridge. Ensure you are appending data sets on WORM media rather than attempting to write over existing data sets.

Code	DLM Health Icon	Cause and Solution
6 (cont.)		<p>Confirm that the cartridge is the correct media type. If it is, determine whether the problem is associated with writing or reading data to a single cartridge or multiple cartridges.</p> <p>Problems Writing Data on a Cartridge with a Known Barcode</p> <p>Retry the operation with a different cartridge.</p> <ul style="list-style-type: none"> ▪ If the operation succeeds, the original cartridge was defective. If possible, copy data from the defective cartridge and set the original cartridge aside. If additional tests confirm that the cartridge was the source of the error, you can discard it. ▪ If the operation fails and another drive is available, insert the original cartridge into the other drive and retry the operation. <ul style="list-style-type: none"> ▪ If the operation fails, discard the defective cartridge. ▪ If the operation succeeds, use the Drive Health Verification wizard to test the original drive (see Using DLM to Test a Drive on page 379). ▪ If the drive fails the DLM drive test, contact Spectra Logic Technical Support (see Contacting Spectra Logic on page 7). ▪ If the drive passes the DLM drive test, the error was temporary. ▪ If the operation fails and another drive is not available, use the Drive Health Verification wizard to test the drive. <ul style="list-style-type: none"> ▪ If the drive fails the DLM drive test, contact Spectra Logic Technical Support. ▪ If the drive passes the DLM drive test, retry the operation to determine whether the error was temporary. If the operation fails again, discard the cartridge. <p>Problems Reading Data on a Cartridge with a Known Barcode</p> <p>Perform one of the following procedures:</p> <ul style="list-style-type: none"> ▪ If another drive is available, insert the cartridge into the other drive and retry the operation. <ul style="list-style-type: none"> ▪ If the operation fails, discard the defective cartridge. ▪ If the operation succeeds, use the Drive Health Verification wizard to test the original drive (see Using DLM to Test a Drive on page 379). ▪ If the drive fails the DLM drive test, contact Spectra Logic Technical Support (see Contacting Spectra Logic on page 7). ▪ If the diagnostics succeed, the error was temporary. ▪ If another drive is not available, use the Drive Health Verification wizard to test the drive. <ul style="list-style-type: none"> ▪ If the drive fails the DLM drive test, contact Spectra Logic Technical Support. ▪ If the drive passes the DLM drive test, retry the operation to determine whether the error was temporary. If the operation fails again, discard the cartridge. <p>Problems with One or More Cartridges with Unknown Barcodes</p> <p>If the problem occurs with multiple tape cartridges or if you do not know the tape cartridge's barcode, use the Drive Health Verification wizard to test the drive (see Using DLM to Test a Drive on page 379).</p> <ul style="list-style-type: none"> ▪ If the drive fails the DLM drive test, contact Spectra Logic Technical Support (see Contacting Spectra Logic on page 7). ▪ If the drive passes the DLM drive test, the problem is not related to the drive.

Code	DLM Health Icon	Cause and Solution
7		<p>High probability of media error. An error occurred because of a faulty tape cartridge.</p> <ul style="list-style-type: none"> ▪ Ensure the tape cartridge is the correct media type: <ul style="list-style-type: none"> ▪ See LTO Read/Write Compatibility on page 491 for information about which media is compatible with each LTO drive generation. ▪ Drive does not accept an expired cleaning cartridge. ▪ Drive does not accept a WORM cartridge when running diagnostic tests in Maintenance Mode. ▪ Drive does not write over existing data sets on a WORM cartridge. Ensure you are appending data sets on WORM media rather than attempting to write over existing data sets. ▪ If another drive is available, insert the cartridge into the other drive and retry the operation. <ul style="list-style-type: none"> ▪ If the operation fails, discard the defective cartridge. ▪ If the operation succeeds, use the Drive Health Verification wizard to test the original drive (see Using DLM to Test a Drive on page 379). ▪ If the drive fails the DLM drive test, contact Spectra Logic Technical Support (see Contacting Spectra Logic on page 7). ▪ If the diagnostics succeed, the error was temporary. ▪ If another drive is not available, use the Drive Health Verification wizard to test the drive. <ul style="list-style-type: none"> ▪ If the drive fails the DLM drive test, contact Spectra Logic Technical Support. ▪ If the drive passes the DLM drive test, retry the operation to determine whether the error was temporary. If the operation fails again, discard the cartridge. <p>Note: The error code clears when you reset or power cycle the drive or when you place it in maintenance mode.</p>
8		<p>SCSI interface or Fibre Channel failure.</p> <p>A failure occurred in the drive hardware or in the SCSI bus. The error code clears after 10 seconds if the error does not recur. If the error persists, contact Spectra Logic Technical Support (see Contacting Spectra Logic on page 7).</p>
9		<p>RS-422 error.</p> <p>The drive determined that a drive interface or library interface failure occurred. The error code clears after 10 seconds if the error does not recur. If the error persists, contact Spectra Logic Technical Support (see Contacting Spectra Logic on page 7).</p>

Code	DLM Health Icon	Cause and Solution
A		<p>Degraded operation.</p> <p>The drive determined that a problem occurred that degraded the operation of the drive, but it did not restrict continued use.</p> <p>The drive is usable, though the single-character display (SCD) continues to indicate an error and the status light flashes amber. The error code may clear when you cycle power to the drive.</p> <ol style="list-style-type: none"> 1. Reset the drive (see Resetting a Drive on page 351) to clear the error code. 2. Confirm that the drive is using the current firmware version (see Updating Drive Firmware on page 419) and update the firmware if necessary. 3. Use the Drive Health Verification wizard to test the drive (see Using DLM to Test a Drive on page 379). 4. If the problem persists, contact Spectra Logic Technical Support (see Contacting Spectra Logic on page 7).
C		<p>Cleaning indicator.</p> <p>The drive needs to be cleaned, or is in the process of loading the cleaning cartridge or being cleaned. The error code clears when you clean the drive and unload the cleaning cartridge. See Cleaning a Drive on page 412 for instructions.</p>
d		Two drives on the Fibre Channel loop have the same Arbitrated Loop Physical Address.
E		The Fibre Channel port connection is off-line.
e		<p>The drive detected a configuration error during an encryption operation.</p> <ol style="list-style-type: none"> 1. Retry the encryption operation with the suspect cartridge in another encryption enabled drive. 2. Replace the cartridge if you see the same problem in multiple drives.
F		<p>Drive Fiber Cable error.</p> <p>The Fibre Channel drive does not detect light or a related diagnostic failed to detect light through the fiber optic connection to the drive.</p> <ul style="list-style-type: none"> ▪ Verify the fiber cables and connections between the drive and the host are the correct type and are working properly. Verify all equipment and devices are powered ON. ▪ Verify the configuration settings for the drive are set correctly and are compatible with the topology of the network. ▪ Verify that the host fiber adapter and port are working properly and are compatible with the topology of the network. ▪ Verify that the Fibre Channel switch ports are working properly and are compatible with the topology of the network. ▪ Verify that the fiber cable is connected to Port A (0) of the drive. ▪ Verify that Port A (0) on the Fibre Channel drive is working properly by using ITDT to run the “Function Code 6: Run Host Interface Wrap Test.”
J		<p>Incompatible Media.</p> <p>The drive determined that incompatible media was loaded into the drive.</p>

Code	DLM Health Icon	Cause and Solution
P		The cartridge in the drive is write-protected. The storage management software cannot write data to a write-protected cartridge. The library cannot update the cartridge MAM when the cartridge is write-protected.
u		Firmware update is in progress.
b, c, H, h, n, o	N/A	Reserved or not actively in use, or no error or message assigned. There may be a problem with the SCD. Reset the drive and determine whether all segments on the SCD are lit. <ul style="list-style-type: none"> ▪ If they are all lit, confirm that the drive is using the current firmware version (see Updating Drive Firmware on page 419) and update the firmware if necessary. ▪ If the problem persists, contact Spectra Logic Technical Support (see Contacting Spectra Logic on page 7).
...	N/A	The message display lost communication with the drive. This message appears on Line 2 of the message display. The three dots may occasionally display during normal processing.

TS11xx Technology MCD Codes

MCD Code Descriptions for TS11xx Technology Drives A variety of messages that indicate the current drive status can be displayed on the drive's 8-character panel. In the case of an error, a Failure ID message is displayed. A Failure ID has the format **FIDx yy**, where **x** indicates the severity of the failure and **yy** indicates the error code. The following tables shows the status codes for TS11xx technology drives. The table on [page 376](#) shows the Failure ID Code descriptions for these drives.

Status Code	Description
<blank>	The following are possible reasons for the display to be blank: <ul style="list-style-type: none"> ▪ The drive is not powered on ▪ The drive is ready ▪ There is no status ▪ No cartridge is mounted
<all 8 elements fully lit>	The reset/power-on process is in progress. The diagnostic test is verifying that all elements are working.

Status Code	Description
AJAR*	<p>A cartridge is in the opening of the drive and is not in a loadable position, or if no cartridge or other obstruction is in the drive, the sensor may not be functioning correctly, and the hardware may be defective. If no cartridge or other obstruction is in the drive, contact Spectra Logic Technical Support (see Contacting Spectra Logic on page 7).</p> <p>If you cannot insert a tape cartridge in the drive, perform the following steps:</p> <ol style="list-style-type: none"> 1. Make sure that you have the proper cartridge type. 2. Inspect the tape cartridge for damage. 3. Make sure that there is no other cartridge already in the drive. 4. Try to load another cartridge into the drive. Use a scratch cartridge to avoid possible damage to a data cartridge. <p>If the new cartridge can be inserted in the drive, the original cartridge may be defective. Inspect the cartridge again for damage.</p> <p>If the cartridge is not damaged but it cannot be inserted, contact Spectra Logic Technical Support (see Contacting Spectra Logic on page 7).</p>
CLEAN*	Drive cleaning is in progress.
CODELOAD	Microcode is being loaded. This process takes a few minutes. The drive should not be powered off or reset during this process.
DIAGS*	Diagnostics are running.
EMPTY*	There is no cartridge in the opening of the drive. Alternatively, if a cartridge is in the drive, the sensor may not be functioning correctly, and the hardware may be defective. If a cartridge is present in the drive, contact Spectra Logic Technical Support (see Contacting Spectra Logic on page 7).
ERASE*	Data erase is in progress.
LOAD*	A load is complete. The cartridge is at the load point.
LOCATE*	A locate is in progress.
MIDTAPE*	The drive was reset or powered on with a tape loaded, and is in the process of bringing the drive and tape to a recovered state. This process may take up to 15 minutes.
NEW CODE	Codeload is complete. The drive is in process of resetting to apply the new code.
READ*	A data read is in progress.
READY*	The drive is in ready state. (The panel can also be blank in ready state)
RESET* and RESET!!!	The drive is in the process of resetting.
REWIND*	A rewind operation is in progress.
UNLOAD*	An unload was requested, or is in progress.
@UNLOAD*	<p>An unload is complete, the cartridge is in the unloaded position.</p> <p>Note: The display goes blank when the cartridge is removed.</p>
WRITE*	A data write is in progress.

The following table lists the Failure ID codes for the TS11xx technology drives.

Failure ID Code	Description	Action
5F	A function was attempted which is prohibited due to the current security settings.	This code is not related to a drive or microcode problem. It is related to the operating environment and requires additional investigation. Contact Spectra Logic Technical Support (see Contacting Spectra Logic on page 7).
81-85	Drive problem.	<p>Perform the following:</p> <ol style="list-style-type: none"> 1. If possible, use ITDT to collect a drive dump file (see Use the IBM Tape Diagnostic Tool (ITDT) to Retrieve a Drive Dump on page 359). If you cannot use ITDT, use the BlueScale user interface to collect a drive trace file (see Use the Drive Traces Button on page 357). 2. Reset the drive (see Resetting a Drive on page 351), then retry the operation that produced the error. 3. If the problem persists, contact Spectra Logic Technical Support and send the drive trace file to them, if requested (see Contacting Spectra Logic on page 7). <p>Note: The error code clears when you reset or power cycle the drive.</p>
86	Cartridge or drive problem.	See Failure ID code FE on page 378 .
87	Cartridge problem.	See Failure ID code FE on page 378 .
8A	Drive performance problem.	Contact Spectra Logic Technical Support (see Contacting Spectra Logic on page 7).
90	Drive problem.	Contact Spectra Logic Technical Support (see Contacting Spectra Logic on page 7).
9C	Hardware or configuration problem.	Contact Spectra Logic Technical Support (see Contacting Spectra Logic on page 7).
AA, AB, AC, AD	Configuration problem.	Contact Spectra Logic Technical Support (see Contacting Spectra Logic on page 7).
AE, AF	Hardware problem.	Contact Spectra Logic Technical Support (see Contacting Spectra Logic on page 7).
BF	Hardware problem.	Contact Spectra Logic Technical Support (see Contacting Spectra Logic on page 7).
C1	Drive problem.	Contact Spectra Logic Technical Support (see Contacting Spectra Logic on page 7).
D8	Drive problem.	Contact Spectra Logic Technical Support (see Contacting Spectra Logic on page 7).

Failure ID Code	Description	Action
E4	Drive problem.	Contact Spectra Logic Technical Support (see Contacting Spectra Logic on page 7).
E5, E6	Drive or microcode problem.	Contact Spectra Logic Technical Support (see Contacting Spectra Logic on page 7).
ED	Informational message.	A microcode dump exists in flash memory. Contact Spectra Logic Technical Support (see Contacting Spectra Logic on page 7).
F2, F4	Cartridge or Drive problem.	Contact Spectra Logic Technical Support (see Contacting Spectra Logic on page 7).
F5	Fibre Channel error.	<ul style="list-style-type: none"> ▪ Verify that the fiber cables and the connections between the drive and the host are the correct type and are working properly. Verify that all equipment and devices are powered ON. ▪ Verify that the configuration settings for the drive are set correctly and are compatible with the Fibre Channel topology being used. ▪ Verify that the host fiber adapter and port are working properly and are compatible with the Fibre Channel topology being used. ▪ Verify that the Fibre Channel switch ports are working properly and are compatible with the Fibre Channel topology being used. ▪ Verify that the fiber cable is connected to Port A (0) of the drive.
F6	The drive needs to be cleaned.	See Cleaning a Drive on page 412 for instructions.
F7	Fibre wrap test failure.	Contact Spectra Logic Technical Support (see Contacting Spectra Logic on page 7).

Failure ID Code	Description	Action
FE	Cartridge or drive problem.	<p>Verify that the tape is the correct media type. If the tape cartridge is the correct media type, perform the following action:</p> <p>Problems Writing Data on a Cartridge with a Known Barcode</p> <p>Retry the operation with a different cartridge.</p> <ul style="list-style-type: none"> ▪ If the operation succeeds, the original cartridge was defective. If possible, copy data from the defective cartridge and set it aside. If additional tests confirm that the cartridge was the source of the error, you can discard it. ▪ If the operation fails and another drive is available, insert the original cartridge into the other drive and retry the operation. <ul style="list-style-type: none"> ▪ If the operation fails, discard the defective cartridge. ▪ If the operation passes, contact Spectra Logic Technical Support. ▪ If the operation fails and another drive is not available, contact Spectra Logic Technical Support. <p>Problems Reading Data on a Cartridge with a Known Barcode</p> <p>Perform one of the following procedures:</p> <ul style="list-style-type: none"> ▪ If another drive is available, insert the cartridge into the other drive and retry the operation. <ul style="list-style-type: none"> ▪ If the operation fails, discard the defective cartridge. ▪ If the operation succeeds, contact Spectra Logic Technical Support. ▪ If another drive is not available, contact Spectra Logic Technical Support. <p>Problems with One or More Cartridges with Unknown Barcode</p> <p>If the problem occurs with multiple tape cartridges or if you do not know the tape cartridge's barcode, contact Spectra Logic Technical Support (see Contacting Spectra Logic on page 7).</p>
FF	Operator procedure or host problem.	<p>This error code is presented for an invalid or unsupported SCSI command or parameter. It is a SCSI application program software problem. Sense data exists at the host.</p>

USING DLM TO TEST A DRIVE

Overview BlueScale Drive Lifecycle Management (DLM) lets you monitor the DLM health information of each drive in the library and helps you identify drives that experience a high number of errors or other problems during operation. See [Chapter 10 – Using Drive Lifecycle Management](#), beginning on [page 288](#) for detailed information about using DLM to monitor the health of drives.

If you suspect that a drive is experiencing problems or if the Drive Lifecycle Management report indicates that a drive is experiencing repeated errors, you can use the DLM Drive Health Verification wizard to test the drive. This test, when used in conjunction with other DLM data and MLM data, can help you determine whether a drive or the media is the source of the errors you are investigating.

Note: The DLM Drive Health Verification test takes approximately 15 minutes to complete.

Requirements for Using the Wizard

Before you can run the DLM Drive Health Verification wizard, the following requirements must be met:

- The drive must not contain a cartridge.
- A scratch tape must be available in the partition's entry/exit pool. The scratch tape must have the following qualities:
 - It must be the same media type and generation as the drive being tested.
 - It must have a cartridge health of Good (green) for an MLM-enabled cartridge or Usable for a cartridge that is not MLM-enabled.
 - It must have a barcode label.
 - If the scratch cartridge is encrypted with BlueScale encryption, the key must be stored in the library



Caution

Make sure that the scratch tape does not contain data that you need to retain. The test process overwrites all data on the tape.



Important

The test fails if the scratch tape does not meet the conditions listed above.

Note: If the cartridge health is unknown (that is, it is not currently listed in the library's MLM database), the library loads the cartridge into a drive to determine the health before beginning the test.

- If a cleaning partition is associated with the partition containing the drive, make sure the cleaning partition contains a cleaning cartridge with Good (green) or Usable health. You can use MLM to determine the health of the cleaning cartridges currently in the cleaning partition (see [Generate MLM Reports on page 273](#)). If necessary, import a known good cleaning cartridge into the cleaning partition (see [Importing into a Storage or Cleaning Partition on page 202](#)).

If the partition does not use a cleaning partition, a cleaning cartridge with Good or Usable health must be in the partition's entry/exit pool. Import a known good cleaning cartridge into the entry/exit pool (see [Importing into a Storage or Cleaning Partition on page 202](#)).

**Important**

When importing a cleaning cartridge into the partition's entry/exit pool, it must be in a regular TeraPack magazine; it *cannot* be in a Maintenance TeraPack magazine.

- Notes:**
- Both the scratch tape and the cleaning cartridge can be imported into the entry/exit pool in the same magazine.
 - The test aborts (fails) if the cleaning cartridge health is not Good or Usable.
 - The cleaning cartridge must have a barcode label.
 - If the entry/exit pool contains only one chamber, both the cleaning cartridge and the scratch cartridge must be in the same magazine.
- Only a user with superuser or administrator privileges can perform a DLM Drive Health test. See [Understanding User Groups and Security on page 90](#) for information about the three types of user groups and what types of privileges each has.

Run the DLM Drive Health Verification Wizard

Use the following steps to launch the DLM Drive Health Verification wizard.

1. Log into the library as a user with superuser or administrative privileges.
2. If necessary, import a scratch tape and a cleaning cartridge into the library (see [Requirements for Using the Wizard on page 379](#)).
3. From the toolbar menu, select **Configuration** ... **DLM** to display the Drives screen.

Note: The **Test** button is not present if DLM is not enabled.

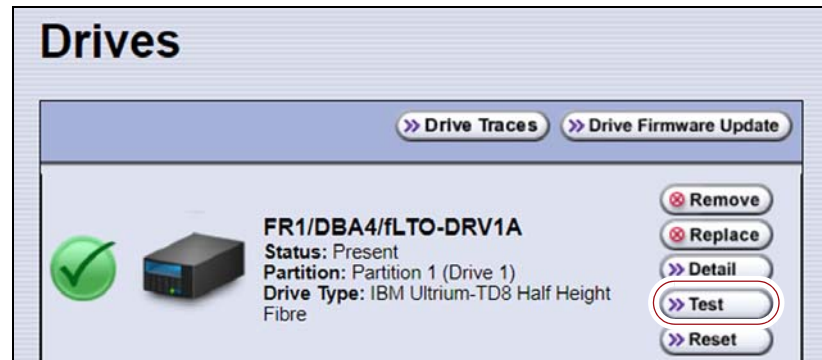

Figure 207 Click **Test** on the Drives screen to launch the wizard.

4. Click **Test** next to the drive you want to test to start the DLM Drive Health Verification wizard.

The wizard determines whether all of the requirements for the test are met.

All Requirements Met If all of the requirements for performing the test are met, the Drive Health Verification screen displays a warning about the upcoming test process. Proceed to [Step 5 on page 382](#).



Figure 208 Click **Next** on the Drive Health Verification screen to begin the verification process.

Requirements Not Met If one or more requirement needs attention, the Drive Health Verification screen displays information about what needs to be done.

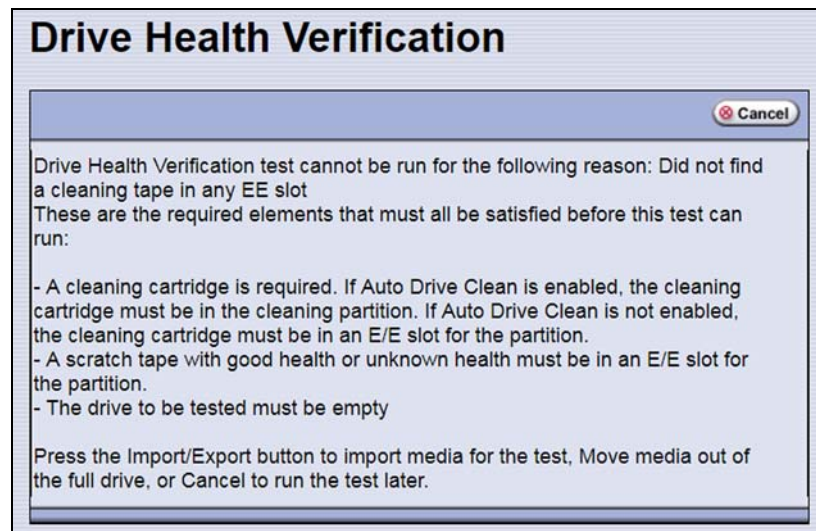

Figure 209 Address all of the requirements on the Drive Health Verification screen.

Note: If you are accessing the library remotely using the BlueScale web interface and either the scratch cartridge or the cleaning cartridge is not available, then **Cancel** is the only option available.

Use the following steps to address the requirements listed on the Drive Health Verification screen.

- a. Click **Move** or **Import/Export**, as required, to move a cartridge out of the drive or import a scratch cartridge and a cleaning cartridge into the partition.
 - b. After you complete the necessary actions, begin the entire process again, starting with [Step 3 on page 381](#).
 - c. When all of the requirements are met, proceed to [Step 5](#).
5. Click **Next** to display the DLM Select Scratch Cartridge screen.

6. On the DLM Select Scratch Cartridge screen, select the scratch cartridge you want to use for the test.

Note: Only data cartridges located in the partition's entry/exit pool are listed and available for selection.



Caution

If the entry/exit pool contains multiple data cartridges, make sure that you select a cartridge that does not contain data that you want to retain. The test process overwrites all data on the tape.

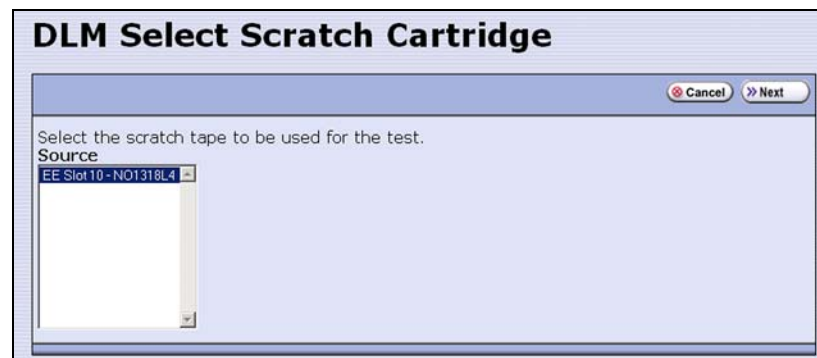

Figure 210 The DLM Select Scratch Cartridge screen.

7. Click **Next** to begin the automatic test process. A series of status screens lets you know how the test is progressing. The test process requires approximately 15 minutes to complete.
8. When the test is complete, review the DLM Test Results screen to determine the outcome of the test and respond as required.
 - If the drive passes the test, the drive health is set to Good (green). You can continue using the drive.



Figure 211 The DLM Test Results screen (test successful).

- If the drive fails the test, the drive health is set to Poor (red). Contact Spectra Logic for assistance (see [Contacting Spectra Logic on page 7](#)).

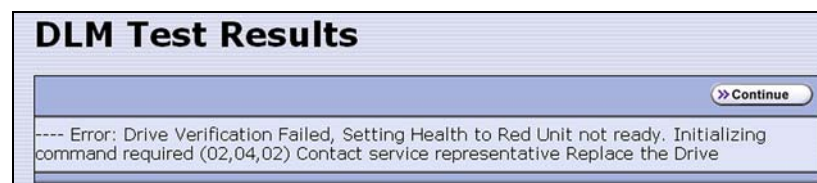

Figure 212 The DLM Test Results screen (test failed).

9. Click **Continue** to return to the Drives screen.

CHAPTER 14

Maintaining the Library

This chapter describes the common maintenance tasks for the Spectra T950V library. See [Chapter 15 – Maintaining the Drives](#), beginning on [page 411](#) for detailed information about maintaining the library’s drives.



Important

Contact Spectra Logic Technical Support before making any changes to your library hardware or performing any maintenance operations.

Topic	
Updating, Servicing, or Moving the Library	page 385
Renewing the BlueScale Software Support Key	page 386
Updating the BlueScale Software and Library Firmware	page 388
Check the Library BlueScale Software Version	page 389
Check Component Firmware Versions (Optional)	page 390
Check the Currently Released BlueScale Version	page 392
Download the BlueScale Package	page 393
Prepare for the BlueScale Package Update	page 394
Install the Update Package	page 395
Manage Update Packages	page 408
Installing Cord Locks	page 409
Installing Cord Locks	page 409
Calibrating the Touch Screen	page 410

UPDATING, SERVICING, OR MOVING THE LIBRARY

Contact Spectra Logic Technical Support before making any changes to your library hardware or performing any service operations.

Installing Additional Drives

Installing an additional drive into a partially filled DBA causes the library to reassign element addresses. To avoid errors, reconfigure your storage management software after adding a new drive (refer to your software documentation for instructions).

Servicing the Library

In the event that it is necessary to replace a component, make sure that you have instructions for performing the procedure *and* you either:

- Are instructed to do so by Spectra Logic Technical Support,
— OR —
- Have a support contract such as Assisted Self-Maintenance (ASM).

Moving the Library

After the library is installed, do not move the library. Do not remove any library components (except the TeraPack magazines).



Important

Moving the library without assistance from a Spectra Certified Field Engineer voids your service contract. Contact Spectra Logic Technical Support for assistance if you need to relocate your library (see [Contacting Spectra Logic on page 7](#)).

RENEWING THE BLUESCALE SOFTWARE SUPPORT KEY

You must have a current support agreement and corresponding BlueScale Software Support key entered in the library before you can update the library's BlueScale software and the component firmware. You are able to download updated BlueScale packages from the Technical Support portal without a key; however, without a valid BlueScale Software Support key installed on the library, you are not able to apply the updates to the library.

- Notes:**
- Spectra Logic sends you an email notification before your current support key expires.
 - The library also generates informational messages to let you know that the support key is about to expire.

If your BlueScale Software Support key expires, you see the following screen when you attempt to update the library.



Figure 213 The BlueScale Software Support Key Expired screen.

You must renew the BlueScale Software Support key before you can continue. You must have a current service contract to generate a new BlueScale Software Support key, if you do not have a current service contract, contact Spectra Logic Technical Support (see [Contacting Spectra Logic on page 7](#)).

If your library is covered by warranty or a service contract, and you need a BlueScale Software Support key, follow these steps:

1. Log into your account on the Technical Support portal at support.spectrallogic.com.

Note: See [Accessing the Technical Support Portal on page 444](#) for information about creating an account and accessing the Technical Support portal.

2. Select **Downloads**  **Service Key Generation**.

3. The Service Key Generation page displays with a list of the products you own. In the Product Name column, click the product for which you want to generate a service key.

Service Key Generation

Click on the product in the *Name* column below to generate a BlueScale Software Service key. Then, install the key in your Spectra product before software can be applied.

If your serial number is not listed below, please contact SMaSH@spectrallogic.com and provide the serial number(s) you need added.

Service keys are only valid for units that are currently covered under a Spectra Logic Support Agreement. If your support agreement is not current, please contact contracts@spectrallogic.com for information about renewing and/or reinstating your contract.

Name ↑	SLA	ASM	Support Contract Expiration	Service Key
PTH0335005 - Spectra T950 Library	Next Business Day Replacement	None	12/31/2050	VZZ 3MF BHS K9K DUR

Figure 214 The Service Key Generation screen.

4. On the Software Support Keys Generator page, the **Product Name**, **Product Type**, and **Serial Number** fields are populated with the information for your library. Click **Generate Key**. The page refreshes to display the new Product Service Key.

BlueScale Software Service Key Generator

"If you haven't clicked the "Generate Key" button below, the displayed key is your existing key.

Once you have generated the service key, enter it either through the library's front panel, or the Remote Library Control (RLC) interface.

- For T50e libraries, navigate to **Configuration > Option Keys > New**.
- For all other Tape Series libraries, navigate to **Configuration > System**.

Generate Software Support Key

Product Name:
PTH0335005 - Spectra T950 Library

Product Type:
Spectra T950 Library

Serial Number:
PTH0335005

Product Service Key:
VZZ 3MF BHS K9K DUR

[Generate Key](#) [Back](#)

Figure 215 The Software Support Key Generator page.

5. After you generate your key, enter it into the library as described in [Enter Activation Keys on page 97](#).

UPDATING THE BLUESCALE SOFTWARE AND LIBRARY FIRMWARE

Overview The BlueScale software and library firmware are updated regularly to provide new functionality and resolve issues. Spectra Logic recommends that you keep your library up-to-date at all times. If your library is not using the most current BlueScale software version, updating it to the most current version is strongly recommended.



Important

Your library must either still be under warranty or you must have a current service contract with Spectra Logic Technical Support before you can perform BlueScale package updates, including firmware updates for library components. The BlueScale Software Service key associated with your service contract must be entered into the System Configuration screen before you can update the library.

- For instructions on how to renew and enter your BlueScale Software Support key, see [Renewing the BlueScale Software Support Key on page 386](#).
- If you have questions about your service agreement, contact Spectra Logic Technical Support (see [Contacting Spectra Logic on page 7](#)).

New Package Availability The most currently released version of the BlueScale package for the library is available on the Product Software page on the Technical Support portal.

If Auto Download is configured (see [Configure a Package Server on page 129](#)), the library checks configured package servers once a week for a library update package newer than what the library is currently running. If a new package is available, the library downloads it, posts a system message, and displays an icon on the status bar to indicate the update is available (see [Auto Download Icon on page 79](#)). If the library already downloaded an update package, you can continue with [Prepare for the BlueScale Package Update on page 394](#).

Package Support Packages are groupings of program code that contain the BlueScale software and firmware for the library components. Spectra Logic provides complete support for the two most recently released BlueScale packages. If your library is not running the most current BlueScale software version, you may be required to update your library to resolve an issue or to verify that the problem still exists.

The Spectra *T950V Library Release Notes and Documentation Updates*, available on the Technical Support portal, provides information about the updates in the current BlueScale package, as well as updates to this guide and other documentation.

User Privilege Requirements All users can view the BlueScale software version that the library is using on the status bar at the bottom of each screen (see [Figure 29 on page 78](#)). Only a user with superuser or administrator privileges can update the library. See [Understanding User Groups and Security on page 90](#) for information about the three types of user groups and what types of privileges each has.

Check the Library BlueScale Software Version

Use the following steps to determine the BlueScale software version currently running on the library.

1. Log into the library as a user with superuser or administrator privileges.
2. Determine the BlueScale software version currently running on the library.
 - The status bar at the bottom of each BlueScale screen shows the BlueScale version running on the library.

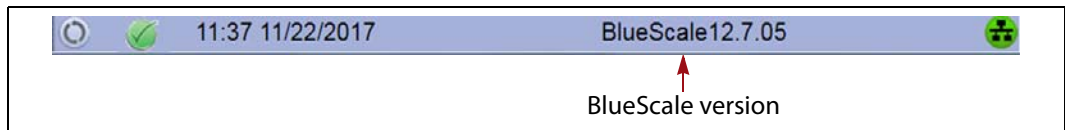

Figure 216 The BlueScale version shown on the status bar.

— OR —

- Select **Maintenance** ... **Package Update** from the toolbar menu to view the current BlueScale package version on the Package Update screen.

Note: If the library notifies you that your BlueScale Software Support key expired, see [Renewing the BlueScale Software Support Key](#) on page 386.

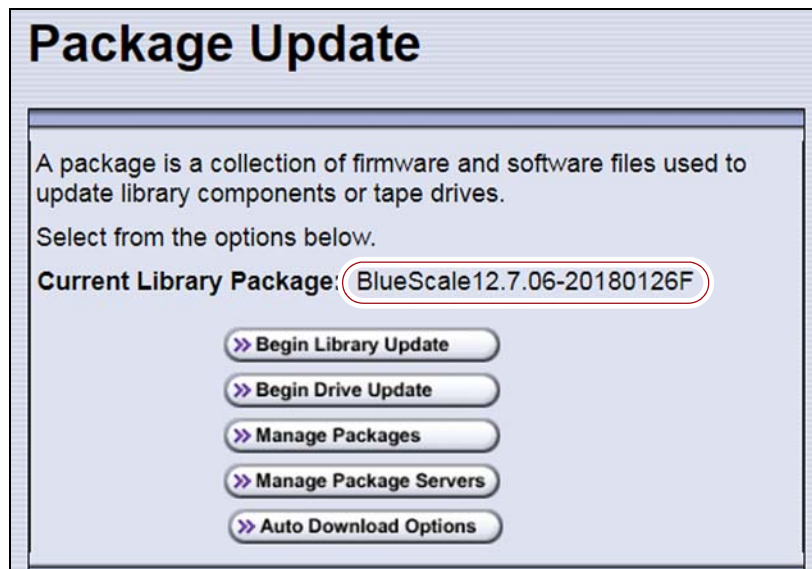

Figure 217 The BlueScale version shown on the Package Update screen.

Check Component Firmware Versions (Optional)

Note: This is typically only useful when recommended by Spectra Logic Technical Support.

1. Log into the library as a user with superuser or administrator privileges.
2. From the toolbar menu, select **Maintenance**  **Tools**. The Maintenance Tools screen displays.



Figure 218 The Maintenance Tools screen.

3. If you want to save the information about the firmware versions to a USB device, connect a USB device to a USB port on the LCM or the operator panel and allow time for the device to mount.

Note: The option to save the information to a USB device is only displayed if you connect a USB device before you select **Utilities** (see [Using a USB Device on page 157](#)).
4. Select **Utilities**. The Utilities screen displays.
5. Select **Display Firmware Versions**. The Utilities screen refreshes to show a description of the Display Firmware Versions tool.



Figure 219 Select the **Display Firmware Versions** utility.

- If you want to save the output from the utility, use the check boxes at the top of the screen to select the location; otherwise skip to [Step 7](#).

Selecting this location...	Saves the output...
Mail results to:	<p>As an attachment to an email sent to the specified mail recipient. Use the drop-down list to select the recipient for the report file.</p> <p>To send the email with the output to someone who is not already listed as a library user, you must first configure that person as an email recipient (see Configure Mail Users on page 106).</p> <p>Note: Do not use the default <i>autosupport@spectralogic.com</i> email recipient unless Spectra Logic Technical Support specifically instructs you to do so. Spectra Logic does not save emailed results files unless they are specifically requested for troubleshooting.</p>
Save to USB	<p>To a USB device connected to a USB port on the LCM or the operator panel.</p> <p>Note: This option is only available if you inserted a USB device in Step 3 on page 390.</p>

- Click **Run Utility**. The Utility Results screen displays, showing a list of the firmware levels for all installed components.

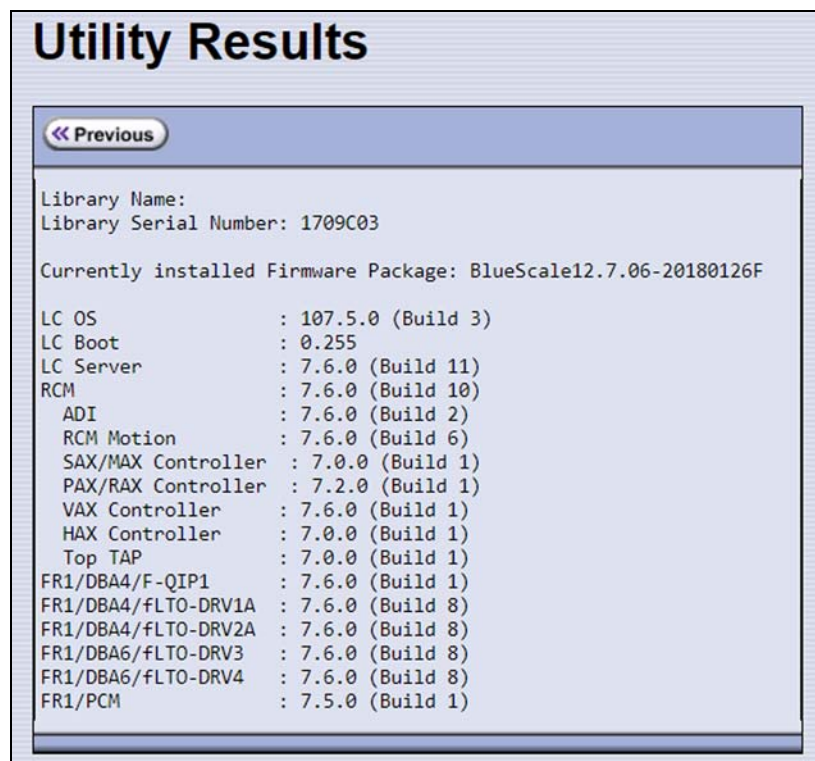



Figure 220 The results screen for the Display Firmware Versions utility.

- If requested to do so, send this information to Spectra Logic Technical Support (see [Contacting Spectra Logic on page 7](#)) for advanced troubleshooting.

Check the Currently Released BlueScale Version

Follow these steps to check the currently recommended BlueScale version:

1. Log into your user account on the Technical Support portal at support.spectrallogic.com.
Note: See [Accessing the Technical Support Portal on page 444](#) for information about creating an account and accessing the Technical Support portal.
2. Select **Downloads**  **Product Software**.
3. On the Product Software page, locate your library type in the **Spectra Product** column. The currently released BlueScale version is listed in the **Current Version** column.

Tape Libraries				
Spectra Product	Zipped Version <i>(Use this file if you are upgrading from a version below 12.07.02.)</i>	Digitally Signed Version <i>(Use this file if you are upgrading from version 12.07.02 or higher.)</i>	File Size (KB)	Release Notes
TFinity	BlueScale12.7.00.07-20170906F.hpz	N/A	<i>Please contact Support for this update</i>	TFinity Library Release Notes and Documentation Updates
T950	BlueScale12.7.02-20170623F.2lpz	BlueScale12.7.02-20170623F.2lps	72,977/8	T950 Library Release Notes and Documentation Updates

Figure 221 The Product Software screen.

4. Compare the Current Version available for the library to the version installed on the library.

Download the BlueScale Package

If Auto Download is configured (see [Configure a Package Server on page 129](#)) or your library has Internet access and you plan to download the BlueScale package directly to the library from the Spectra Logic package server, skip to [Prepare for the BlueScale Package Update on page 394](#).

If your library cannot access an outside website because of security or firewall restrictions, use the following steps to download the BlueScale package from the Technical Support portal. You can save the BlueScale package to a USB device or a previously configured package server.

1. Log into your account on the Technical Support portal at support.spectralogic.com.
2. Select **Downloads** ❖ **Product Software**. The Product Software page displays.

Tape Libraries				
Spectra Product	Zipped Version <i>(Use this file if you are upgrading from a version below 12.07.02.)</i>	Digitally Signed Version <i>(Use this file if you are upgrading from version 12.07.02 or higher.)</i>	File Size (KB)	Release Notes
TFinity	BlueScale12.7.00.07-20170906F.hpz	N/A	<i>Please contact Support for this update</i>	TFinity Library Release Notes and Documentation Updates
T950	BlueScale12.7.02-20170623F.2lpz	BlueScale12.7.02-20170623F.2lps	72,977/8	T950 Library Release Notes and Documentation Updates

Figure 222 The Product Software screen.

3. Locate your library type in the **Spectra Product** column. The currently released BlueScale version is listed in the **Current Version** column.
- Note:** Select a package ending with the letter “s”, which indicates a digitally signed package.
4. Click the name of the BlueScale package next to your library type. The BlueScale package begins downloading through your web browser.
 5. When the download completes, do not unzip the downloaded file. Copy the file to one of the following locations:

- The root directory of a USB device.

- Notes:**
- The library only recognizes FAT-formatted, not NTFS-formatted, USB devices.
 - Not all USB devices are compatible with the library. If you are unable to access a USB device from the library, remove it and use a different one.

— OR —

- A previously configured package server.

Prepare for the BlueScale Package Update

Use the following sections to prepare to update the BlueScale software and library component firmware.

Make Sure Your BlueScale Software Support Key Is Current

Updating the BlueScale software and the firmware for the library components requires a current service contract with Spectra Logic Technical Support. If your service contract expires, renew it as described in [Renewing the BlueScale Software Support Key on page 386](#).

Prepare the Library

1. Stop all library- and host-based operations.

Note: At the start of a package update that includes RCM or LCM updates, the library shuts down all exporters, (RIM2 and drive) so that they do not accept additional moves and then waits for any moves in progress to complete before starting to update the selected components. At the start of a package update that includes RIM2 updates only, the library shuts down the exporters needing an update so that they do not accept additional moves and then waits for any moves in progress to complete before starting to update the selected components. The exporters are re-enabled to accept moves when the package update completes.

- Back up your MLM database (see [Back Up the MLM and DLM Databases on page 282](#)).

Note: Backing up the MLM database also backs up the DLM database.

- Back up all of your BlueScale encryption keys (see the *Spectra Tape Libraries Encryption User Guide*).
- Download and read the *T950V Library Release Notes and Documentation Updates* for the most current information about updated BlueScale packages.



Important

If the release notes provide special procedures or requirements for updating the library, make sure that you follow them.

Install the Update Package

Select the BlueScale Package and Update Options

1. Log into the library as a user with superuser or administrator privileges.
2. If you downloaded the BlueScale package to a USB device or if you plan to update the RCM control modules or RIM2 controllers using a USB device, connect the USB device to the USB port on the LCM and wait for the device to mount **before** continuing (see [Using a USB Device](#) on page 157).
3. If you receive an error message stating that your disk is full when the library attempts to unzip a BlueScale package, you need to delete downlevel packages before you can continue. See [Manage Update Packages](#) on page 408.
4. Select **Maintenance** > **Package Update**. The Package Update screen displays.

Note: If the library notifies you that your BlueScale Software Support key expired, see [Renewing the BlueScale Software Support Key](#) on page 386.

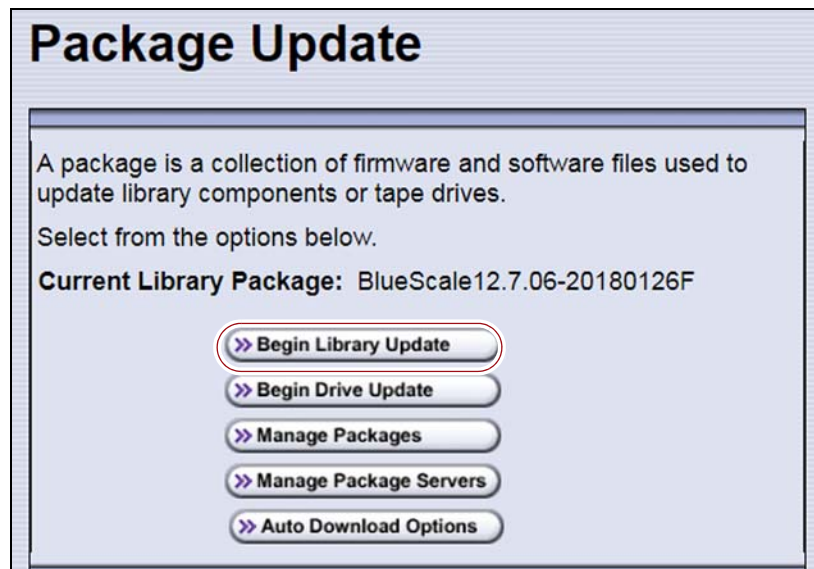

Figure 223 Click **Begin Library Update** to start the process.

5. Click **Begin Library Update**. If the License Agreement screen displays, read the license agreement, then click **Accept**.

Note: If you decline the agreement, you are not able to update the library.

6. The Select Library Package screen displays, listing the file names for the available BlueScale packages.

Note: The file names begin with the BlueScale version number, followed by the date of release in YYYYMMDD format.



Figure 224 Select the BlueScale package.

7. Select the appropriate BlueScale package.

- Notes:**
- If the Package does NOT display in the USB or Package server section, you may have downloaded the package for the wrong library type or the wrong signed/unsigned package type.
 - BlueScale packages may be found on the sources described in the table below.

Source	Description
Spectra Logic	Select and download the desired BlueScale package from Spectra Logic's package server to the memory card in the LCM and then install it. Notes: <ul style="list-style-type: none"> ▪ The library must have a connection to the Internet before you can use this option (see Configure Network Settings on page 104). ▪ If directed to do so by Spectra Logic Technical Support, update the IP address and package directory for the Spectra Logic package server (see Configure a Package Server on page 129).
Memory Card	Select the desired BlueScale package from packages already stored on the memory card in the LCM.

Source	Description
USB Device	<p>Select the desired BlueScale package from packages stored on a USB device. There is a brief delay while the library accesses the USB device when you select this option.</p> <p>Notes:</p> <ul style="list-style-type: none"> ▪ The USB Device option is only available if you connected a USB device containing the BlueScale package in Step 2 on page 395. ▪ The BlueScale package must be stored in the root directory of the USB device.
Configured Package Server (server name varies)	<p>Select the desired BlueScale package stored on a previously configured package server, if you have one available.</p> <p>Note: This option is only available if you previously configured a package server. See Configure a Package Server on page 129 for information about configuring a package server.</p>

8. Click **Next**. The Library Package Update Options screen displays.

The Library Package Update Options screen only lists options that are applicable based on your library configuration.

Note: Clicking **Update** immediately starts the update process. Spectra Logic recommends that you select using a USB device to update RIM2 controllers (see [Step 11 on page 401](#)) and, if the library does not have EtherLib, using a USB device to update RCM control modules (see [Step 9 on page 399](#)) before clicking **Update**.

Library Package Update Options

Package: BlueScale12.7.06-20180126F

<< Previous Cancel >> Details Update

Set options below. Click **Update** to begin the package update, or **Details** to view the changes that will be made using the selected package.

Using a USB device to update firmware can speed up the update process.

- Update RCM controllers using USB device
- Update RIM2 controllers using USB device

An EtherLib connection was detected and will be used to update the RCMs. Select the strategy to use if the update cannot complete over EtherLib:

- Automatically restart update over the library's internal network (can take up to 45 minutes per RCM)
- Do not automatically restart update

Select where to save the current library configuration before the update begins:

Email to First Last ▾

By default, the library updates its support record at Spectra Logic when the update completes. Select the check box below to turn off this feature for this update.

- Do not update support record

Figure 225 The Library Package Update Options screen.

9. If the library includes drive expansion frames, determine the appropriate update method for your library's configuration:

EtherLib EtherLib is an Ethernet network that connects Spectra LS control modules to each other to increase communication speed. Using EtherLib significantly reduces the time required for RCM firmware updates.

Select the appropriate EtherLib completion option for your library's environment. The library uses this option if the update cannot successfully complete over EtherLib.

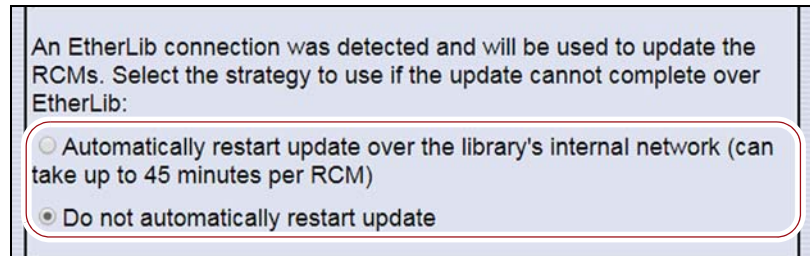

Figure 226 Select the appropriate EtherLib completion strategy.

Note: EtherLib completion options are not present if the library does not detect the EtherLib network.

If your library uses EtherLib and this option does not display, see [Library has EtherLib, but EtherLib options do not display in Package Update](#) on page 324.

Selection	Action
Automatically restart update over the library's internal network	The library restarts the update, but performs it over the library's internal communication network. This increases the amount of time the update requires, up to 45 minutes per RCM.
Do not automatically restart update	<p>If the update fails, the library does not automatically restart the update. The BlueScale update is incomplete.</p> <p>Note: If the update fails, examine any system messages and the package update log to determine the cause of the failure. If the library is power-cycled, there may be a system message that refers to an "RCM firmware mismatch". Resolve the problems that caused the failure and retry the update.</p> <p>If the update cannot be performed using EtherLib, retry the update using the Update RCM controllers using USB device method.</p>

Update RCM Controllers Using USB Device If your library has drive expansion frames and does not use EtherLib, you can choose to update the RCM controllers using a USB device. This shortens the time required to complete the update.

Note: If your library is configured to use EtherLib, performing the update using EtherLib is faster than using the USB device option.

Select **Update RCM controllers using USB device** on the Library Package Update Options screen.

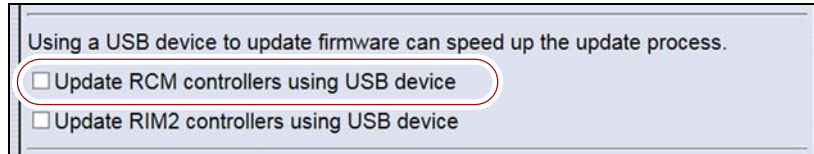

Figure 227 Select **Update RCM controllers using USB device**.

Note: If your library has an EtherLib network, and you select **Update RCM controllers using USB device**, the library uses the USB device method to update the RCMs.

10. If the library includes RIM2 controllers, determine whether or not to update them using a USB device. This significantly shortens the time required to complete the update, but requires manual intervention.

Note: You can only update RIM2 controllers, not RIM controllers, using the USB option.

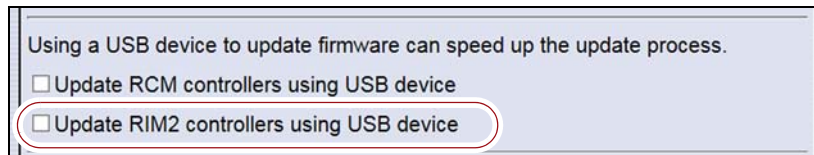

Figure 228 Select **Update RIM2 controllers using USB device**.

Select **Update RIM2 controllers using USB device** on the Library Package Update Options screen.

11. On the Library Package Update Options screen, select whether and where you want to backup the library configuration before performing the update.

- Notes:**
- Spectra Logic highly recommends that you save the library configuration before updating.
 - The backup of the library configuration does not include the MLM or DLM databases.



Figure 229 Select whether and where you want to backup the library configuration.

Choice	Action
Save to USB device	Saves a backup of the library configuration to a USB device. Using this option is highly recommended to ensure that you can easily restore the library if necessary. Note: The Save to USB device option is only available if you connected a USB device in Step 2 on page 395 .
Email to...	Emails a backup of the library configuration file to an already-configured mail recipient. Note: The Email to option is only available if you previously configured mail recipients (see Configure Mail Users on page 106).
Do not save	Updates the library without saving a backup of the library configuration. This is not recommended unless you backed up the library configuration right before starting the package update procedure.

12. On the Library Package Update Options screen, select whether or not an email is sent to Spectra Logic Technical Support to update the library's support records.

- Notes:**
- Sending a notification to Spectra Logic Technical Support is highly recommended.
 - This notification does not include the configuration backup file.
 - This option is only available if you previously configured the *autosupport@spectralogic.com* mail user's SMTP IP address (see [Create or Modify a Profile on page 302](#)).



Figure 230 Select whether or not you want to send an update to Technical Support.

13. (Optional) To view a list of components affected by the BlueScale package, click **Details** to view the Library Package Details screen. A Library Package Details screen, similar to the one shown, displays.

Any items that need to be upgraded or downgraded to match the BlueScale package you chose are automatically selected. Components with auto-staged firmware are marked with an asterisk (*).

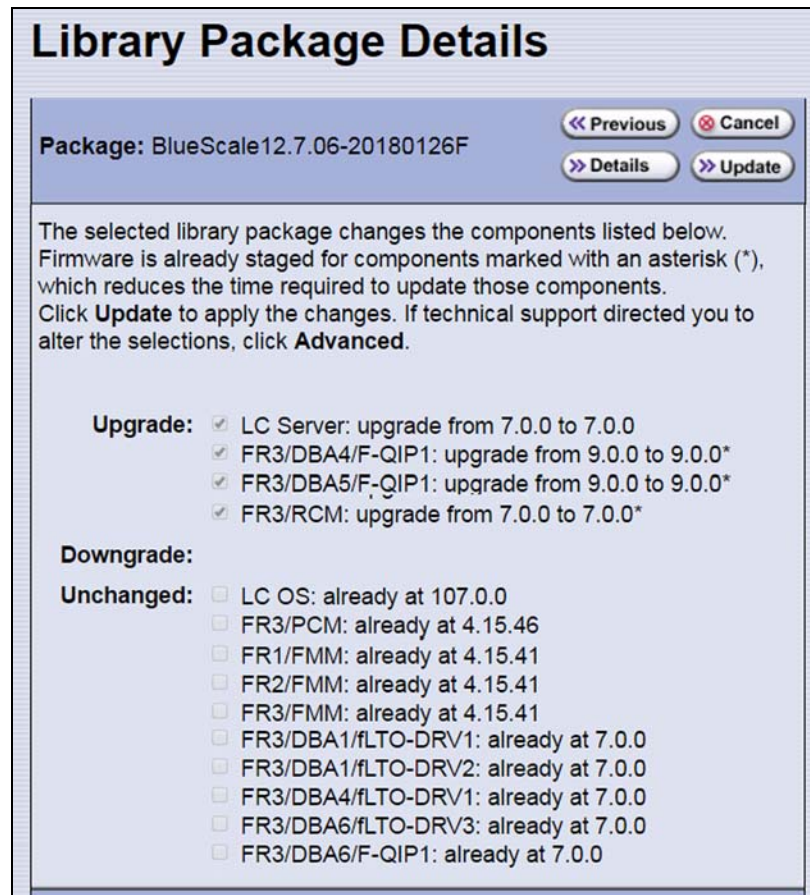

Figure 231 The Library Package Details screen.

14. (Optional) Use the advanced firmware update procedure to limit which components get upgraded or downgraded.



Caution

Use the advanced firmware update procedure only when directed to do so by Spectra Logic Technical Support.

- a. Click **Advanced** on the Library Package Details screen. An Advanced Package Update screen, similar to the one shown, displays.

- b. Select or clear the check box next to the library components:
- Clear the check box to prevent the component from upgrading or downgrading.
 - Select the check box to force a component to update to the firmware level supplied by the BlueScale package. Depending on the firmware, this could be an upgrade, downgrade, or reapplying the current firmware.

For example, clear everything except **LC Server** to update just the LC Server firmware.

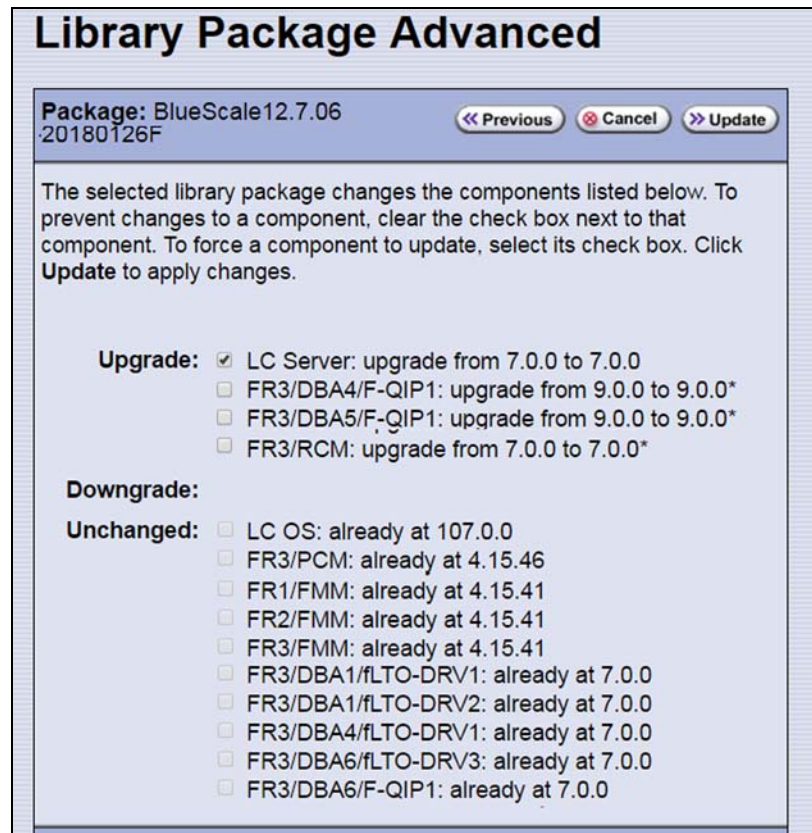

Figure 232 The Library Package Advanced screen.

- Notes:**
- Updating all of the automatically selected components is highly recommended.
 - Occasionally, Spectra Logic Technical Support may instruct you to update a firmware component even if it is already at the same level as the component in the selected BlueScale package.
 - Components with auto-staged firmware are marked with an asterisk (*).

Begin the Update

1. Click **Update** to begin the update process.



Important

Once the update process starts, it cannot be canceled.

Do not turn off power to the library or power-down any component being updated during the update process.

2. The process depends on whether you chose the **Update RCM controllers using USB device** option in [Step 9 on page 399](#) or the **Update RIM2 controllers using USB device** option in [Step 10 on page 400](#).

Note: Depending on which components you selected to update, some steps may be skipped.

Update using USB device options selected	Update Process
<p>Both options cleared or not applicable (The library has an EtherLib network or does not have any drive expansion frames, and does not have any RIM2 controllers.)</p>	<p>The library begins the update process and displays a progress screen, which remains for the duration of the update. Depending on what components are updated, the process can take from several minutes to an hour or more.</p>

Update using USB device options selected	Update Process
<p>Update RCM controllers using USB device selected</p> <p>or</p> <p>Update RIM2 controllers using USB device selected</p> <p>or</p> <p>Both</p>	<p>The library starts the update wizard, which guides you through the update process. Based on your selections, the wizard instructs you to connect and remove the USB device from various components.</p> <p>Notes:</p> <ul style="list-style-type: none"> ▪ Each time you connect the USB device to a component, wait at least 10 seconds for the USB device to mount, and then click Continue. ▪ If you do not respond to the Feedback Required screen within 10 minutes, the request times out and the component update fails. ▪ Each component takes 5-10 minutes to update. <p>If you selected both Update RCM controllers using USB device and Update RIM2 controllers using USB device, the process is as follows:</p> <ol style="list-style-type: none"> 1. On the Feedback Required screen, confirm that you connected a USB device to a USB port on the LCM (in Step 2 on page 395). The library copies a file containing the appropriate RCM firmware to the device. 2. A Feedback Required screen prompts you to remove the USB device from the LCM and connect it to the specified RCM. 3. When the RCM update is complete, a Feedback Required screen prompts you to remove the USB device and connect it to the next RCM. This is repeated until all RCM control modules are updated. 4. When all of the RCM updates are complete, a Feedback Required screen prompts you to move the USB device back to the LCM. The library copies a file containing the appropriate RIM2 firmware to the USB device. 5. A Feedback Required screen prompts you to remove the USB device from the LCM and connect it to a RIM2. This is repeated until all RIM2 controllers are updated.

3. When complete, the Package Update Results screen displays, showing that the update completed successfully or that a component failed to update.

Note: If the update fails, examine any system messages and the package update log to determine the cause of the failure. Resolve the problems and perform the update again. For further information, see [Troubleshooting](#) below.

4. If you used a USB device during the update process, disconnect it.

5. Click **Finish** to complete the update. Updates do not take effect until the library completes the update process.

**Important**

Always click **Finish** to complete the BlueScale update process. **Do not** manually reboot the LCM, power-cycle the library, or perform any other operations on the library when you see the Package Results screen. Doing so may cause the update process to fail.

Note: If you are using the BlueScale web interface to perform the update, the connection to the library is lost when the LCM reboots. Allow sufficient time for the LCM to complete its initialization, then enter the library's IP address in your web browser to reconnect.

6. When the update completes, the library automatically sends an email to Spectra Logic Technical Support if it is configured as a mail recipient and you selected this option in [Step 12 on page 401](#).
7. After the update completes, use your storage management software to restart any backup processes.

Troubleshooting

If you encounter problems while performing a package update, examine any system messages and the package update log to determine the cause of the failure. Resolve the problems and retry the update.

LCM does not automatically reboot If the update package includes updates to software running on the LCM (LC server, WebServer, etc.) or RCM the LCM reboots when you click **Finish**. Wait at least five minutes for the LCM to complete its initialization. If the LCM does not reboot correctly, reseal the LCM and perform the Package Update process again.

Component failed to update Click **Finish** to complete the update. When the LCM resets, reseal the component that failed to update, and perform the Package Update process again. If the component fails to update a second time, contact Spectra Logic Technical Support. See [Contacting Spectra Logic on page 7](#).

Library configuration is corrupted during the update process Use the following steps to restore the library's configuration if it becomes corrupted during the package update process.



Caution

The **Restore Configuration from Checkpoint** utility should only be used immediately after a package update is performed.

Any library configuration or inventory changes made between the time that the package update is performed and the utility is run are lost.

Note: The library automatically saves a Checkpoint Configuration Backup file prior to beginning a package update.

1. From the toolbar menu, select **Maintenance ... Tools**. The Maintenance Tools screen displays.
2. Select **Utilities**. The Utilities screen displays.
3. Click **Show Advanced**. The Advanced Utilities Confirmation screen displays.
4. Click **Next**. The Utilities screen refreshes to show a list of the advanced utilities.
5. Scroll through the list of advanced utilities and select **Restore Configuration from Checkpoint**. The screen refreshes to show the details for the utility.

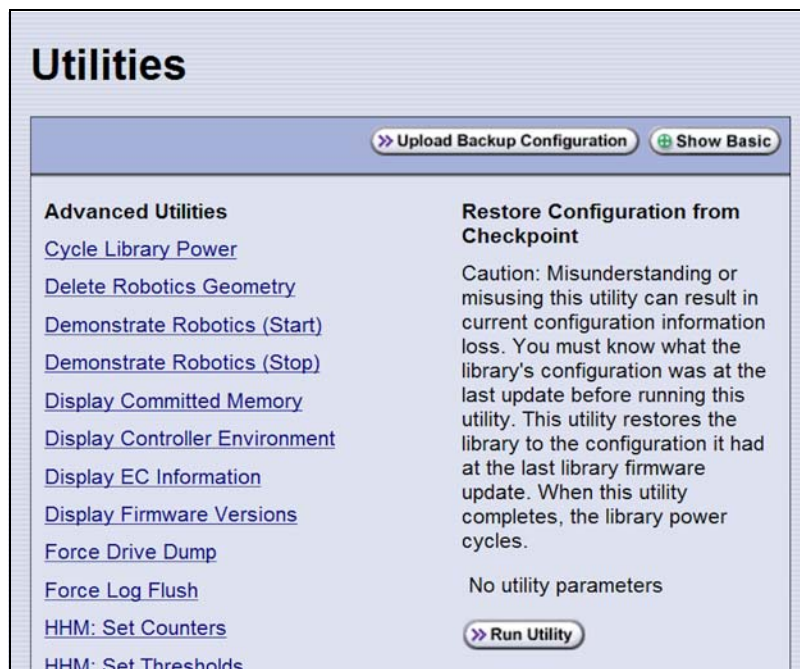

Figure 233 The Advanced Utilities screen.

6. Click **Run Utility** to restore the library to the Checkpoint library configuration.
7. After the library configuration restores, perform the Package Update process again.

Manage Update Packages

The BlueScale packages downloaded to the library reside on the memory card in the LCM. Over time, the packages (one per update) accumulate on the card and the library may post an error message notifying you that the memory card is full. You must delete downlevel packages before you can continue; you can also choose to delete downlevel packages at other times.

Deleting a package file *does not* delete the BlueScale software or component firmware already applied to the library; it simply removes the package file from local storage on the LCM.

Note: There is no confirmation request before the selected package is deleted. Make sure that you no longer need access to a package file before you delete it.

The following steps describe how to delete unwanted BlueScale packages from the memory card in the LCM.

1. Log into the library as a user with superuser or administrator privileges.
2. From the toolbar menu, select **Maintenance** ... **Package Update**. The Package Update screen displays (see [Figure 223](#) on page 395).
3. Click **Manage Packages**. The Manage Packages screen displays with a list of all the package files currently stored on the memory card in the LCM.



Figure 234 Select the BlueScale packages you want to delete.

4. Select the package(s) that you want to delete, then click **Delete Selected**. The package delete process begins.

INSTALLING CORD LOCKS

Install the cord locks included with each frame to prevent the power cords from being inadvertently disconnected from the dual AC input connectors.

Note: The photos in this section show installing the cord locks on a dual AC power module. The parts and the procedure are the same for the dual AC with convenience outlet or the dual AC2 power modules.

1. Pause PostScan if it is running (see [Pause the PostScan Process on page 272](#)). Any tapes currently being scanned are returned to their storage locations.
2. Discontinue all file storage operations to the library.
3. Power off the library (see [Power Off the Library on page 143](#)).
4. Set the AC breaker switches on the dual AC module to the “off” position.
5. If the power cords are plugged into wall plugs, unplug them. Also unplug them from the dual AC module where you plan to install the cord locks.
6. Using a #2 Phillips screwdriver, remove the two screws securing each of the two input plugs to the dual AC module (circled in [Figure 235](#)).

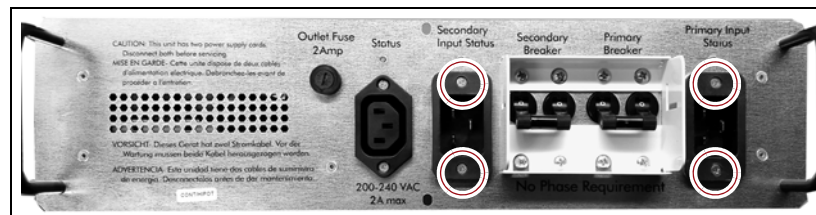

Figure 235 Remove the screws securing the input plugs to the AC power module.

7. Place a cord lock over the connector on the end of the power cord that connects to the library. Orient the cord lock as shown in [Figure 236](#).

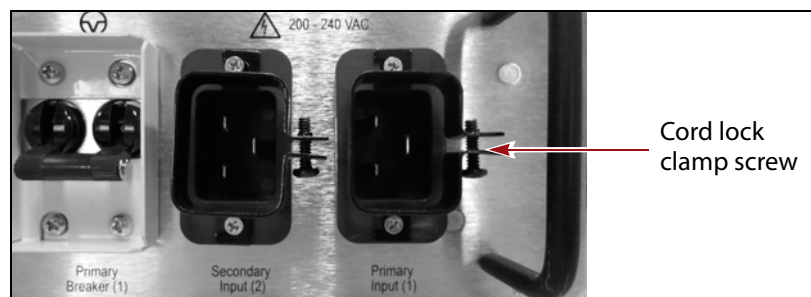

Figure 236 Install the cord locks on the power cords.

8. Push the power cord into the input plug and reinstall the screws that secure the input plug to the dual AC module. Make sure that the cord connector is fully seated in the input plug.

9. Tighten the cord lock clamp screws (shown in [Figure 236](#)).
10. Repeat [Step 7](#) through [Step 9](#) for the other power cord.
11. Plug the free end of each power cord into an appropriate power source.
12. Repeat the entire process for the power cords attached to the dual AC module in each drive expansion frame.
13. After cord locks are installed on all of the power cords, set the AC breaker switches to the “on” position and power on the library.

CALIBRATING THE TOUCH SCREEN

If the touch points on the library’s touch screen do not properly align with the user interface graphics, perform the following procedure to recalibrate the position of the touch points.

Note: You must perform this procedure while standing in front of the touch screen. The utility is not available when accessing the library through the BlueScale web interface (RLC).

1. Log into the library as a user with superuser or administrator privileges.
2. From the toolbar menu, select **Maintenance**  **Tools** to display the Maintenance Tools screen ([Figure 218 on page 390](#)).
3. Select **Utilities**. The Utilities screen displays.
4. Select **Calibrate Touch Screen**.
5. Click **Run Utility**. The touch screen displays a series of calibration target points.
6. Touch each point as it displays with either the stylus or your finger to recalibrate the touch points on the screen.

Note: Touch each point at a straight-on angle as close to the center of the target as possible.

7. When the calibration routine is complete, the Utilities screen redisplay.

CHAPTER 15

Maintaining the Drives

This chapter describes the common maintenance tasks for drives in the Spectra T950V library. See [Chapter 14 – Maintaining the Library](#), beginning on [page 384](#) for information about maintaining the library.

Topic	
Cleaning a Drive	page 413
Determine Whether Cleaning is Required	page 414
Prepare the Library for Drive Cleaning	page 415
Determine the Cleaning Method	page 416
Manually Cleaning a Drive	page 417
Track Cleaning Cartridge Use	page 419
Updating Drive Firmware	page 420
Prepare for the Update Process	page 421
Update Using ITDT	page 424
Update Using Drive Update through Package Update	page 427
Update Using the Drive Firmware Update Wizard	page 435
Update Using the Update Drive Firmware Utility	page 438
Updating Drive Device Drivers	page 442
Adding or Replacing a Drive	page 443
Add a Drive to the Library	page 443
Replace a Drive	page 444

CLEANING A DRIVE

Overview Whenever a tape is loaded or unloaded, the read/write heads are physically cleaned by a brush located within the drive. However, after reading and writing a large amount of data (the exact amount varies by drive type and generation) or if read or write errors occur, the drive requests to be cleaned with a cleaning cartridge. The request is made by sending a Tape Alert message to the host, and displaying a **C** on the SCD for an LTO drive or **CLEAN*** on the MCD for a TS11xx technology drive. The notification is also posted to the library's Drive Details screen (Figure 238 on page 415) and the DLM drive health icon for the drive changes to yellow (see [Using the Drive Health Icons on page 291](#) for additional information).

Using drives with dirty heads can reduce drive performance, decrease usable tape capacity, and result in read/write failures which can eventually interrupt data storage.

If you have Auto Drive Clean enabled and the drive is in a partition with an associated cleaning partition, these cleanings are performed automatically. See [Creating a Cleaning Partition on page 166](#) for information about configuring a cleaning partition.

It may also be possible to configure the host software to automatically clean the drives, with a cleaning tape stored in the partition, when the software is notified that drive cleaning is necessary.

If no automatic cleaning process is configured, you must manually clean the drive. If you ignore a cleaning request for too long, the library generates a warning system message.

User Privilege Requirements When Auto Drive Clean is enabled for the storage partition and a cleaning cartridge is available in the cleaning partition, cleanings are performed automatically and do not require user intervention.

If Auto Drive Clean is not enabled, any user with operator privileges who is assigned to the partition and all users with superuser or administrator privileges can manually clean a drive without an associated cleaning partition by importing a cleaning cartridge into the storage partition's entry/exit pool, if necessary, and using the Inventory screen to manually move the cleaning cartridge to the drive (see [No Cleaning Partition Present on page 418](#)).

Only a user with superuser or administrator privileges can move a cleaning cartridge stored in the partition using the BlueScale web interface (RLC).

Determine Whether Cleaning is Required

Clean the library's drives when any of the following occurs:

- The drive indicates that it needs cleaning (see [Chapter 13 – Drive Troubleshooting](#), beginning on [page 350](#)) by sending a message to the storage management software.
- The Drive Details screen indicates that the drive needs cleaning or displays a **C** on the SCD for an LTO drive or **CLEAN*** on the MCD for a TS11xx technology drive (see [Figure 238 on page 415](#)).

Note: In order for the library to monitor drive status, the drive must be configured in a partition.

Use the following steps to use the Drives screen to determine whether a drive requires cleaning.

1. Log into the library as a user with superuser or administrator privileges.
2. Select **Configuration ...> Drives** or **Configuration ...> DLM** if MLM is enabled. The Drives screen displays.



Figure 237 Click **Detail** on the Drives screen.

3. Click **Detail** next to the drive you want to check. The Drive Details screen displays.

If the Cleaning Status displays **Drive Cleaning Required**, clean the drive as described in the following sections.

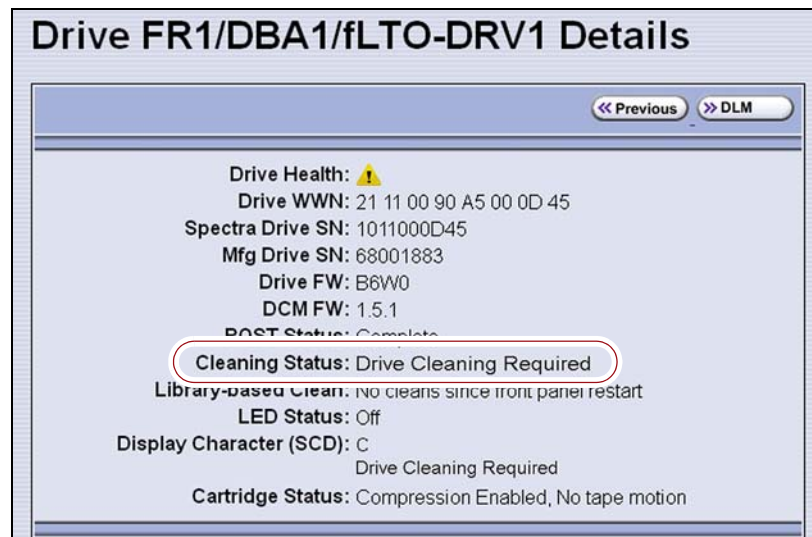

Figure 238 The Cleaning Status indicates that cleaning is required.

Prepare the Library for Drive Cleaning

Before you can clean the drive, you must address the following requirements:

Required Tools and Materials You must have a cleaning cartridge for the type of drive(s) to be cleaned. Cleaning cartridges can be purchased from Spectra Logic. If the cartridge has a barcode label, be sure to note the barcode, including any leading zeros. This information helps you locate the cleaning cartridge after it is loaded into the library.

Important



Using only Spectra Certified cleaning cartridges to clean your drives is highly recommended. For information on ordering these cartridges, see [Media and Media Accessories](#) on page 466.

Carefully follow all instructions and recommendations provided with the cleaning cartridge. Do not rewind and reuse the material in a cleaning cartridge. Reusing the material may redistribute contaminants previously removed from the tape path. If all of the cleaning material is used, discard the cartridge and use a new cleaning cartridge.

Continuing Backups A drive is unavailable for use while it is being cleaned. However, the library's other drives remain available for use.

Determine the Cleaning Method

The method you use to clean the drive depends on the following factors:

If...	Then...
Auto Drive Clean is enabled and a cleaning partition is associated with the storage partition,	<p>The library automatically cleans the drives, including any Global Spares, as needed. See Chapter 6 – Configuring and Managing Partitions, beginning on page 159 for information about configuring a cleaning partition and associating it with one or more storage partitions.</p> <p>You can also clean the drive manually using a cleaning cartridge in the cleaning partition (see Cleaning Partition Present on page 417).</p>
A cleaning partition is not associated with the storage partition; your software package includes features that allow for scheduled drive cleanings,	<p>Use your storage management software to perform regularly scheduled drive cleanings. Refer to your storage management software user manual or vendor for instructions on how to set up scheduled automatic cleanings.</p> <p>You may choose to leave a cleaning cartridge in each storage partition, particularly if you can configure your storage management software to perform regular automated cleanings.</p> <p> Important: Make sure that the cleaning cartridge has a barcode label. Your software must be able to identify the cleaning cartridge and use it only for cleaning drives. Any attempts to use a cleaning cartridge for data storage causes backup failures.</p>
A cleaning partition is not associated with the storage partition and your software package does not have features that allow for scheduled drive cleanings,	<p>Import a cleaning cartridge into the partition and clean the drive manually as described in No Cleaning Partition Present on page 418.</p> <p>You may choose to leave a cleaning cartridge in each storage partition so that it is available whenever you need it.</p> <p> Important: Make sure that the cleaning cartridge has a barcode label. Your software must be able to identify the cleaning cartridge and use it only for cleaning drives. Any attempts to use a cleaning cartridge for data storage causes backup failures.</p>
A Global Spare drive requires cleaning and a cleaning partition is not present,	<p>Prepare and clean the drive as follows:</p> <ol style="list-style-type: none"> 1. Pause the PostScan operation if it is using the Global Spare drive that needs cleaning (see Pause the PostScan Process on page 272). 2. Temporarily substitute the Global Spare drive for a drive in a partition that is associated with the Global Spare drive (see Use the Global Spare Drive on page 353). 3. Clean the drive manually (see No Cleaning Partition Present on page 418). 4. Reclaim the Global Spare drive so that it is again available for use as a spare (see Undo the Global Spare Drive on page 356).

Manually Cleaning a Drive

The process for loading a cleaning cartridge into the drive depends on whether or not a cleaning partition is associated with the storage partition containing the drive you need to clean.

Cleaning Partition Present

If a cleaning partition is present and contains a cleaning cartridge, you can use the **Clean** feature on the Drives screen to manually clean a drive. See [Creating a Cleaning Partition on page 166](#) for information about configuring a cleaning partition.

1. Log into the library as a user with superuser or administrator privileges, or as an operator assigned to the partition.
2. If necessary, import a magazine containing one or more cleaning cartridges into the cleaning partition (see [Importing into a Storage or Cleaning Partition on page 202](#)).
3. Select **Configuration ...> Drives** or **Configuration ...> DLM** if MLM is enabled. The Drives screen displays.

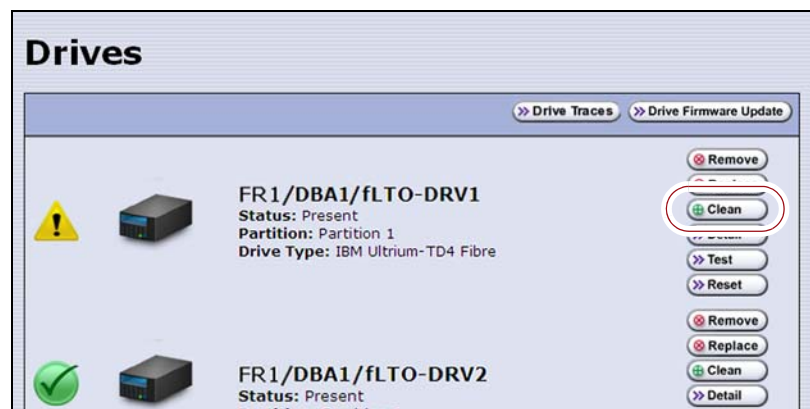

Figure 239 The Drives screen.

4. Click **Clean** next to the drive that needs cleaning. The library retrieves a cleaning cartridge from the cleaning partition and inserts it into the drive. The Drive Cleaning Progress screen displays while the cleaning is in progress.
5. When the cleaning is complete, the library returns the cleaning cartridge to the cleaning partition and displays a status message.

If the cleaning cartridge is MLM-enabled, the cartridge health and Cleans Remaining are updated in the MLM database.

No Cleaning Partition Present

If a cleaning partition is not associated with the storage partition containing the drive you need to clean, a cleaning cartridge must be present in the storage partition's storage pool or entry/exit pool. If you do not permanently store a cleaning cartridge in the storage pool for each partition, you must import one in order to clean a drive.

- If you have an empty chamber in either the entry/exit pool or the storage pool for the partition, import a TeraPack magazine containing a cleaning cartridge.

— OR —

- If you have a TeraPack magazine with one or more empty slots in the entry/exit pool or the storage pool for the partition, you can exchange a magazine or cartridge to import the cleaning cartridge (see [Exporting or Exchanging Magazines and Cartridges on page 209](#)).

Use the following steps to clean the drive.

1. Log into the library.
2. If you keep a cleaning cartridge stored in the storage pool for the partition, use its barcode label information to determine its location, as described in [Locating a Specific Cartridge on page 231](#).
3. If necessary, import the TeraPack magazine with the cleaning cartridge into either the entry/exit pool or the storage pool for the partition containing the drive that needs cleaning, as described in [Importing into a Storage or Cleaning Partition on page 202](#).

Note: If an empty chamber is not available in either the entry/exit pool or the storage pool, exchange the magazine containing the cleaning cartridge for a magazine in one of those pools (see [Exporting or Exchanging Magazines and Cartridges on page 209](#)). When the cleaning is complete, you can exchange the magazines again.

4. Move the cleaning cartridge from the magazine to the drive needing cleaning, as described in [Moving Cartridges Within a Partition on page 231](#).

The drive automatically performs the cleaning, which takes approximately one minute, and ejects the cartridge when finished.

5. Move the cleaning cartridge from the drive back to the magazine from which it came.

6. Check the Drive Details screen to confirm that the cleaning was successful.

If the cleaning cartridge is expired, the drive automatically ejects the cartridge and does not perform the cleaning. The Drive Details screen still indicates that the drive needs cleaning. Perform the following steps before retrying:

 - a. Export the expired cleaning cartridge.
 - b. Import an unexpired cleaning cartridge.
 - c. Repeat [Step 3](#) through [Step 6](#) to clean the drive.
7. If you have additional drives to clean, repeat [Step 3 on page 418](#) through [Step 6](#) for each drive.
8. If you do not want to store the cleaning cartridge in the library, export the magazine containing it, as described in [Exporting or Exchanging Magazines and Cartridges on page 209](#).
9. Make sure that you track the number of times the cleaning cartridge was used (see [Track Cleaning Cartridge Use](#), below).

Note: If you used an MLM-enabled LTO cleaning cartridge, the cartridge usage is tracked in the MLM database.

Track Cleaning Cartridge Use

Cleaning cartridges are valid for a minimum of 50 uses. If you enabled MLM and use MLM-enabled cleaning cartridges, the library tracks the number of cleanings remaining on the cartridge and notifies you when a cleaning cartridge is nearing the end of its useful life. See [Chapter 9 – Configuring and Using Media Lifecycle Management](#), beginning on [page 243](#) for detailed information about using MLM-enabled cleaning cartridges.

If you are not using a Spectra certified cleaning cartridge with MLM enabled in your library, Spectra Logic recommends marking the cleaning cartridge label after each use so that you know when it is near the end of its life cycle.

To purchase MLM-enabled Spectra Certified cleaning cartridges, contact your sales representative or visit the Spectra Logic website at www.spectralogic.com/shop.

UPDATING DRIVE FIRMWARE

Overview Whenever you update your library software, confirm that your drives are using the latest firmware version (see [Determine the Drive Generation and Firmware Version on page 421](#)). Drive firmware updates are also occasionally required to resolve drive issues. When updated drive firmware is available, schedule a drive firmware update at your earliest convenience.

The method you use to update the drives depends on the type of drives you are updating and your operating environment.

- Notes:**
- If Auto Download is configured (see [Configure a Package Server on page 129](#)) and a system message indicates that the library downloaded a new drive firmware package, use [Update Using Drive Update through Package Update on page 427](#) to install the firmware.
 - If you cannot use any of the methods described in the following sections, contact Spectra Logic Technical Support for assistance (see [Contacting Spectra Logic on page 7](#)).

	LTO	TS11xx Technology
IBM Tape Diagnostic Tool (ITDT) To use, install the ITDT utility on a Solaris, Linux, or Windows host connected to the drives to be updated. The update takes 1-2 minutes per drive.	Recommended	Recommended
Drive Update through Package Update Firmware stages in the background (with no impact to library operations) for up to 8 hours for LTO drives and up to 16 hours for TS11xx technology drives; then, when initiated by the user, the drives are updated in parallel. The actual update takes up to 30 minutes for all drives.	Available Recommended if you cannot use ITDT or if the firmware was auto downloaded.	Available Recommended if you cannot use ITDT or if the firmware was auto downloaded.
Drive Firmware Update Wizard Requires one or more firmware update tapes. The update takes about 5 minutes per drive. Multiple drives can be updated in parallel if multiple firmware tapes are used. One partition is processed at a time.	Available	Not Available
Update Drive Firmware Utility Requires a firmware update tape. The update takes about 5 minutes per drive. Updates are performed serially, one partition at a time.	Available	Not Available

User Privilege Requirements The user privileges required to perform a drive firmware update depend on the method used.

- **ITDT** — A user with appropriate permissions to use the host computer on which ITDT is installed.
- **Drive Update through Package Update** — Only a library user with superuser or administrator privileges.
- **Drive Firmware Update wizard** — Only a library user with superuser or administrator privileges.
- **Drive Update Firmware utility** — Only a library user with superuser or administrator privileges.

Prepare for the Update Process

Before you begin the update procedure, make sure you fulfill the prerequisites described in this section.



Important

Always download drive firmware from the Spectra Logic Technical Support portal to ensure that the firmware was qualified by Spectra Logic.



Important

After the drive firmware update is complete, you may need to reset the hosts accessing the drives.



Important

Some operating environments require you to install device drivers before the application software can correctly communicate with the drives. When you update the drive firmware, you may also need to update the device driver for the drive (see [Updating Drive Device Drivers on page 442](#) for further instructions).



Important

DO NOT downgrade the firmware on a drive unless specifically instructed to do so by Spectra Logic Technical Support.

Determine the Drive Generation and Firmware Version

Use the following steps to determine the generation and current firmware version for each drive you plan to update.

1. Log into the library as a user with superuser or administrator privileges.

2. Select **Configuration** > **DLM** (or **Drives**) to view a list of all the drives currently installed in the library.

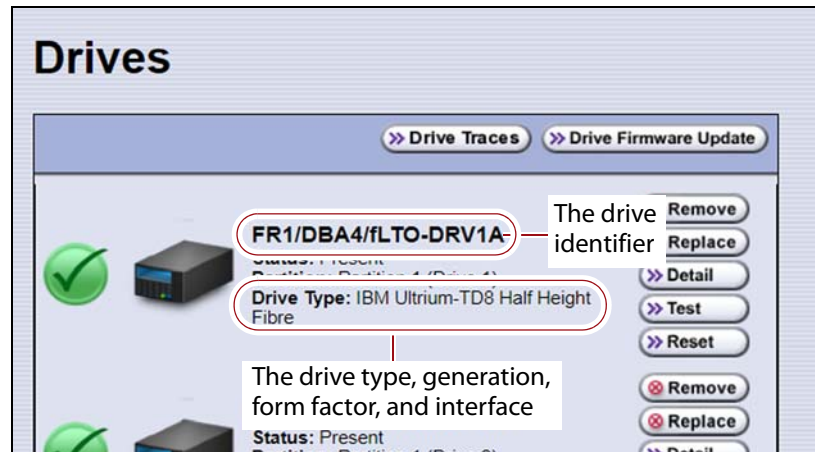

Figure 240 Determine the drive type, generation, and interface.

3. For each drive, make a note of the following information:

Note: If the library contains many drives, it may be easier to use the `drivelist.xml?action=list` command to obtain this information. See the *Spectra Tape Libraries XML Command Reference* for more information.

- **Drive type and generation** — LTO drives are listed as IBM Ultrium-TD n , where n is the generation. TS11 xx technology drives are listed as IBM 3592En n , where $nn=07$ indicates TS1140 technology, $nn=08$ indicates TS1150 technology, and $nn=55$ indicates TS1155 technology.
- **Form factor** — Full-height or half-height.
- **Interface** — Shown in both the Drive Type field and in the Drive Identifier field. Fibre Channel or SAS.

- For each drive, click **Detail** to view information about the current status of the selected drive, including its firmware version.

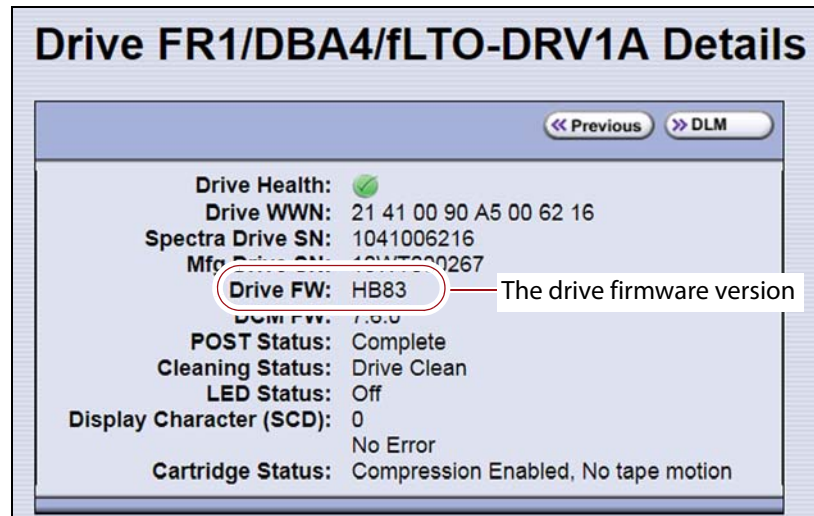

Figure 241 Locate the drive firmware version on the Drive Details screen.

- Make a note of the firmware version the drive is currently using.

Determine Whether an Update is Available

Use the Spectra Logic Technical Support portal to check the currently recommended firmware version for the drives in your library and download updated firmware if it is available.



Important

Always download drive firmware from the Spectra Logic Technical Support portal to ensure that the firmware was qualified by Spectra Logic.

- Log into your account on the Technical Support portal at support.spectralogic.com.

Note: See [Accessing the Technical Support Portal on page 444](#) for information about accessing the Technical Support portal and setting up an account associated with your library.
- Select **Downloads** ⋮ **Tape Drive Firmware**.

- On the Tape Drive Firmware page, locate the appropriate drive firmware with respect to drive type (LTO or TS11xx), generation (for example, LTO-7), interface type (for example, SAS or Fibre), and form factor (full-height or half-height).

LTO-7					
<i>(IBM TotalStorage 3580 Ultrium 7)</i>					
Technology	Form Factor	Current FW File (use with ITDT)	File Size (KB)	Zipped Package File (for staging) <i>Use this file if your library is at a BlueScale version below 12.07.02.</i>	Digitally Signed Package File (for staging) <i>Use this file if your library is at BlueScale 12.07.02 or higher.</i>
Fibre Channel	Full-Height	LTO7_G9Q0.fcp_fh.fmrz	12,142	IBM-LTO7-FH- Fibre_G9Q0- 20161005D.diz	IBM-LTO7-FH- Fibre_G9Q0- 20161005D.dis
Fibre Channel	Half-Height	LTO7_G9Q1.fcp_hh.fmrz	12,165	IBM-LTO7-HH- Fibre_G9Q1- 20161005D.diz	IBM-LTO7-HH- Fibre_G9Q1- 20161005D.dis
SAS	Half-Height	LTO7_G9Q1.sas_hh.fmrz	12,086	IBM-LTO7-HH- SAS_G9Q1- 20161005D.diz	IBM-LTO7-HH- SAS_G9Q1- 20161005D.dis

IBM LTO-7 Drive Firmware Release Notes

Figure 242 A portion of the Tape Drive Firmware page.

- Compare the recommended drive firmware version for each of the drives in your library with the version currently in use (see [Determine the Drive Generation and Firmware Version](#) on page 421).

Update Using ITDT

The easiest way to update your LTO or TS11xx technology tape drive firmware is with the IBM Tape Diagnostic Tool (ITDT).

Note: If your operating system is not supported by ITDT, or you cannot use ITDT in your environment, choose another firmware update method:

- Update Using Drive Update through Package Update on page 427
- Update Using the Drive Firmware Update Wizard on page 435
- Update Using the Update Drive Firmware Utility on page 438

After you check the firmware on the Technical Support portal for the currently recommended firmware version (see [Determine Whether an Update is Available](#) on page 423), follow the instructions in this section to update your drive firmware using ITDT.

Download and Install ITDT

Download ITDT and its related documentation directly from IBM's Fix Central website. For information about navigating IBM's website and downloading the version of ITDT that is appropriate for your operating system, log on to the portal (see [Accessing the Technical Support Portal on page 444](#)), open the Knowledge Base, and search for KBA-01768, *Downloading and installing ITDT (IBM Tape Diagnostic Tool)*.



Important Use the latest version of ITDT to update the latest generation of drives.

Use the following steps to download and install ITDT on a computer that is connected to the same Fibre Channel arbitrated loop or fabric as the drives in the library.

1. Log into IBM's website (<https://www-945.ibm.com/support/fixcentral/>), using your individual IBM ID.
2. Select the **Select product** tab.
3. Select the following options:
 - **Product Group** = System Storage
 - **Select from System Storage** = Tape systems
 - **Select from Tape Systems** = Tape drivers and software
 - **Select from Tape drivers and software** = IBM Tape Diagnostic Tool (ITDT)
 - **Platform** = Select your operating system from the drop-down list and click **Continue**.
4. On the next page, select the version of ITDT that you want to download. If desired, you can select multiple versions.

Note: If you are unsure which version to select, click **Show Fix Details** to see additional information.
5. Click **Continue**. If you did not log into the website yet, it prompts you to do so now.
6. Choose one of the following methods to download the selected ITDT installation files:
 - **Download using your browser (HTTP)**
 - **Download using bulk FTP**
 - **Download using Download Director**
7. Refer to the ITDT documentation for information about using ITDT. Contact Spectra Logic Technical Support if you need assistance (see [Contacting Spectra Logic on page 7](#)).

Download the Drive Firmware

1. After installing ITDT, launch the program so that it creates the **Input** and **Output** folders required during the firmware update process.
2. Log into your account on the Spectra Logic Technical Support portal at support.spectralogic.com.
3. Select **Downloads** ▾ **Tape Drive Firmware**.
4. On the Tape Drive Firmware page (see [Figure 242 on page 424](#)), locate the appropriate drive firmware with respect to drive type (LTO or TS11xx), generation (for example, LTO-7), interface type (for example, SAS or Fibre), and form factor (full-height or half-height).
5. Click the firmware version name in the column labeled **Current FW File**.
Note: The links in the columns labeled Zipped Package File and Digitally Signed Package File are for using Package Update to update the drive firmware (see [Update Using Drive Update through Package Update on page 427](#)) do not select these files if you are updating drive firmware using ITDT.
6. Use your web browser to save the file to the ITDT **Input** folder on the computer where ITDT is installed.

Discontinue Background Operations

You cannot update drive firmware if the library is actively running any background operations, including Media Auto Discovery, PreScan, and PostScan.

If you do not want to wait for a Media Auto Discovery, PreScan, or PostScan operation to complete, you can stop the Media Auto Discovery or PreScan operation, or pause the PostScan operation. For other background operations, you must wait for the process to complete.

- Click **Stop Discovery** on the Media Lifecycle Management Tools screen to stop a Media Auto Discovery or PreScan operation (see [Stop the Discovery Process on page 264](#)).
- Click **Pause PostScan** on the Media Lifecycle Management Tools screen to pause the PostScan operation for one hour (see [Pause the PostScan Process on page 272](#)).

Discontinue Backups and Empty the Drives

Before beginning the drive firmware update process, discontinue all backup operations and remove any cartridges from the drives.



Caution

Attempting to update the firmware while the library is busy or when the drives contain tapes may result in the update failing, failed backup jobs, or permanent damage to the drives. If you did not already do so, stop all backup operations and remove all tapes from the drives you are updating.

- If possible, use your storage management software to move any cartridges that are currently in drives back to their storage locations.
- If you cannot use your storage management software, then move the cartridges as described in [Moving Cartridges Within a Partition on page 231](#).

Update Drives Using ITDT

1. Follow the instructions in the ITDT documentation to update the drive firmware.
2. Reset the updated drives as described in [Resetting a Drive on page 351](#) to restore their configuration settings.
3. After the update is complete, use your storage management software to restart any backup processes.

Update Using Drive Update through Package Update



Important

Your library must either be under warranty or you must have a current service contract with Spectra Logic Technical Support before you can update the drive firmware using Package Update. The BlueScale Software Service key associated with your service contract must be entered into the System Configuration screen before you can use Package Update.

- If you have questions about your service agreement, contact Technical Support (see [Contacting Spectra Logic on page 7](#)).
 - For instructions on how to renew and enter your BlueScale Software Support key, refer to [Service Contract Extension on page 468](#).
-

Drive firmware is downloaded and staged to each drive as a background process. The firmware staging process takes up to 8 hours for LTO drives, and up to 16 hours for TS11xx technology drives. Backups can continue during this process. This does not affect library operation. The update is then applied to all selected drives in parallel. This takes between 15 and 30 minutes, during which time the drives must be empty and idle.

Requirements

- The drives to update must be configured in a storage partition.
- To update the firmware of a Global Spare, first substitute the Global Spare drive for a drive assigned to a partition. After the Global Spare drive completes the firmware update process, it can be removed from the partition and returned to the pool of spare drives (see [Use the Global Spare Drive on page 353](#) for more information).

Download the Drive Firmware

If your library has Internet access, you can download the drive firmware update directly from the Spectra Logic package server. The drive firmware package is downloaded during the update process, and does not need to be downloaded beforehand.

— OR —

Download the recommended drive firmware from the Spectra Logic Technical Support portal, and save it to a USB device or a package server.

1. Connect to the Spectra Logic Technical Support portal.
2. Select **Downloads** ❖ **Tape Drive Firmware**.
3. On the Tape Drive Firmware page (see [Figure 242 on page 424](#)), locate the appropriate drive firmware with respect to drive type (LTO or TS11xx), generation (for example, LTO-7), interface type (for example, SAS or Fibre), and form factor (full-height or half-height).
4. Click the firmware version name in the column labeled **Package File (For Staging)**.
 - Notes:**
 - The link in the column labeled **Current Firmware Version** is for updating the drive firmware using ITDT ([Update Using ITDT on page 424](#)) do not select this file if you are updating drive firmware using Package Update.
 - Select a package ending with the letter “s”, which indicates a digitally signed package.
5. Use your web browser’s download features to save the file to one of the following locations:
 - The root directory of a USB device.

- Notes:**
 - The library only recognizes FAT-formatted, not NTFS-formatted, USB devices.
 - Not all USB devices are compatible with the library. If you are unable to access a USB device from the library, remove it and use a different one.
 - Do not unzip the downloaded file.

— OR —

- A previously configured package server.

Note: The package server option is only available if you previously configured a package server. Refer to [Configure a Package Server on page 129](#) for more information.

Stage the Firmware

1. Log into the library as a user with superuser or administrator privileges.
2. If you downloaded the drive firmware package to a USB device, connect the USB device to a port on the LCM or the operator panel and allow time for the device to mount **before** continuing.
3. Select **Maintenance ...> Package Update** to display the Package Update screen.
4. Click **Begin Drive Update**.



Figure 243 The Package Update screen.

5. If the License Agreement screen displays, read the license agreement, then click **Accept**.

Note: If you decline the agreement, the update process stops.

- The Select Package screen lists the filenames for the firmware update packages.



Figure 244 Select the package for the drive firmware update.

- Select the desired drive firmware package from the list.

Note: If the package does NOT display in the USB or Package server section, you may have downloaded the wrong signed/unsigned package type.

Update packages may be found on the sources described in the table below. Each drive firmware package contains firmware for only one drive generation.

Source	Description
Spectra Logic	Select and download the desired drive firmware package from Spectra Logic's package server to the memory card in the LCM. Notes: <ul style="list-style-type: none"> The library must have a connection to the Internet before you can use this option (see Configure a Package Server on page 129 for instructions for configuring network settings). If directed to do so by Spectra Logic Technical Support, update the IP address and package directory for the Spectra Logic package server (see Configure a Package Server on page 129 for instructions for configuring a package server).
Configured Package Server (server name varies)	Select the desired drive firmware package stored on a previously configured package server, if you have one available. Note: This option is only available if you previously configured a package server (see Configure a Package Server on page 129 for instructions for configuring a package server).
Memory Card	Select the desired drive firmware package from packages already stored on the memory card in the LCM.

Source	Description
USB Device	<p>Select the desired drive firmware package from packages stored on a USB device. There is a brief delay while the library accesses the USB device when you select this option.</p> <p>Notes:</p> <ul style="list-style-type: none"> ▪ The USB Device option is only available if you connected a USB device containing the update package in Step 2 on page 429. ▪ The update package must be stored in the root directory of the USB device.

8. Click **Next**. The Drive Staging Details screen displays.
9. On the Drive Staging Details screen, each drive displays either in the Update or Unchanged section, depending on whether the drive firmware in the update package is different from the drive's current firmware.

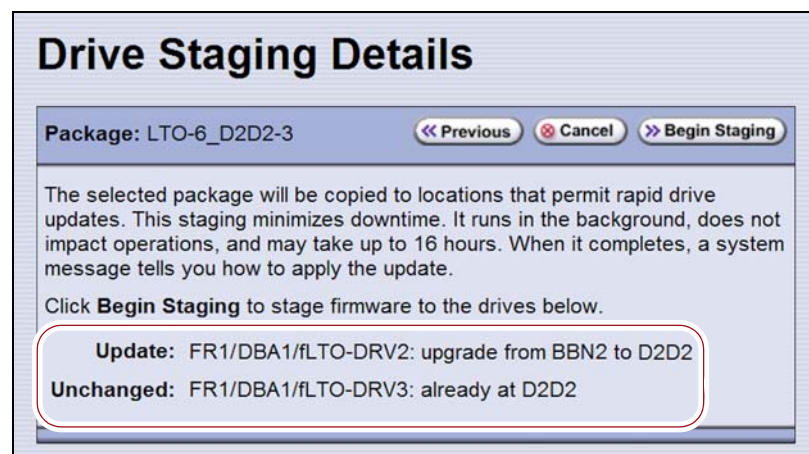

Figure 245 The Drive Staging Details screen.

- Notes:**
- Depending on the location of the file, there may be a few minutes of delay before the information displays.
 - If no installed drives match the selected firmware, the Drive Package Details screen displays, instead of the Drive Staging Details screen.

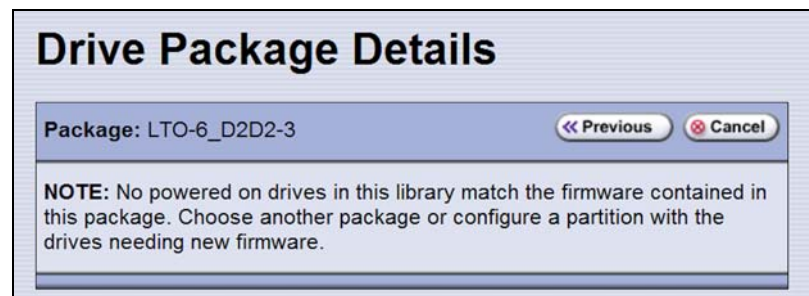

Figure 246 The Drive Package Details screen.

10. Click **Begin Staging**. The Package Update Results screen displays.

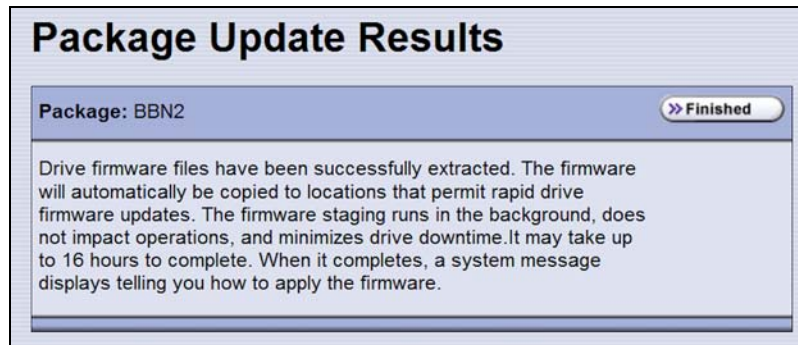

Figure 247 The Package Update Results screen.

All drives that require an update begin staging automatically. This can take up to 8 hours for LTO drives and up to 16 hours for TS11xx technology drives.

- Notes:**
- Staging only prepares the drive for the update process. After staging is complete, you can choose which drives to update in [Step 2 on page 434](#).
 - There may be a few minutes of delay before the Package Update Results screen displays.

11. Click **Finished** on the Package Update Results screen. The firmware staging runs in the background, allowing the library to perform other tasks.

The Drives screen displays the staging status while the process is active.

The Drives screen displays...	when...
	<p>The drive firmware is staging to the drive. The drive icon changes to the staging drive icon, and the staging status line displays.</p> <p>Note: A Global Spare icon does not change to the Drive Staging icon while firmware is staging to it. However, the staging status line displays.</p>
	<p>The drive firmware is finished staging to the drive, and is available to be used to update the drive.</p>

12. When the staging process completes, a system message displays.

- Note:** If there are any failures in staging the firmware to the drives, a system message informs you of the failure. Follow the remedy instructions on the system message and then reset the drive to restart the staging process.

Discontinue Background Operations

You cannot update drive firmware if the library is actively running any background operations, including Media Auto Discovery, PreScan, and PostScan.

If you do not want to wait for a Media Auto Discovery, PreScan, or PostScan operation to complete, you can stop the Media Auto Discovery or PreScan operation or pause the PostScan operation. For other background operations, wait for the process to complete.

- Click **Stop Discovery** on the Media Lifecycle Management Tools screen to stop a Media Auto Discovery or PreScan operation (see [Stop the Discovery Process on page 264](#)).
- Click **Pause PostScan** on the Media Lifecycle Management Tools screen to pause the PostScan operation for one hour (see [Pause the PostScan Process on page 272](#)).

Discontinue Backups and Empty the Drives

Before applying the drive firmware update, discontinue all backup operations and remove any cartridges from the drives.



Caution

Attempting to update the firmware while the library is busy or when the drives contain tapes may result in the update failing, failed backup jobs, or permanent damage to the drives. If you did not already do so, stop all backup operations and remove all tapes from the drives you are updating.

- If possible, use your storage management software to move any cartridges that are currently in drives back to their storage locations.
- If you cannot use your storage management software, then move the cartridges as described in [Moving Cartridges Within a Partition on page 231](#).

Apply the Update

1. On the Drives screen, click **Staged Drive Firmware Update**. The Staged Drive Firmware Update screen displays.

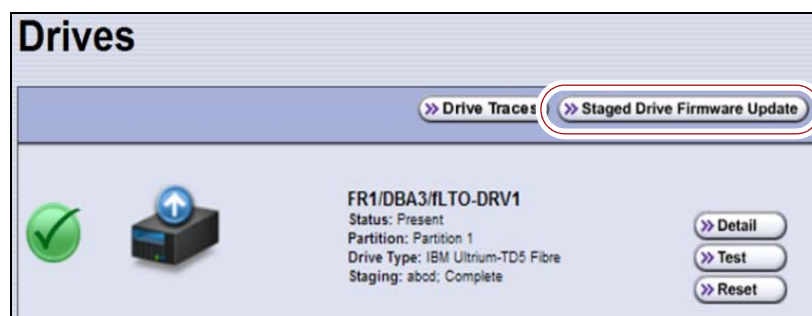

Figure 248 Click **Staged Drive Firmware Update**.

2. Select or clear each drive's check box to indicate whether or not to update the drive.

Note: If a drive is not empty, it is still included in this list; however, its check box is disabled, with a note indicating that a tape is loaded in the drive.

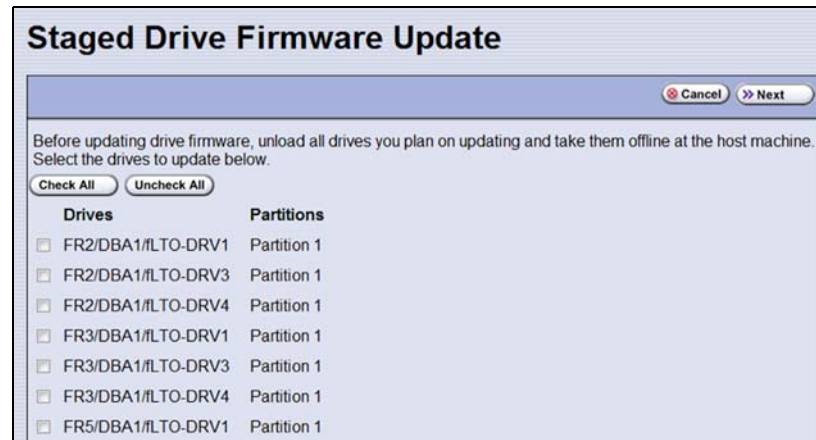



Figure 249 Select the drives to update.

3. Click **Next**. The drive firmware update process begins updating the selected drives in parallel. A progress screen displays until the process completes, in approximately 15 to 30 minutes.

The Drives screen displays...	when...
 <p>FR1/DBA4/FLTO-DRV1 Status: Present Partition: Partition 1 Staging: abod; Committing</p>	<p>The library starts the firmware update process. The staging status line changes to "Committing".</p>
 <p>FR1/DBA1/FLTO-DRV1 Status: Present Partition: Partition 1 Drive Type: IBM Ultrium-TD5 Fibre</p>	<p>The drive firmware update process is complete. The staging drive icon changes back to the drive icon, and the staging status line disappears.</p>

4. After the drive firmware update completes, the Staged Firmware Update Result screen displays the results of the update process. Click **OK** to return to the Drives screen.

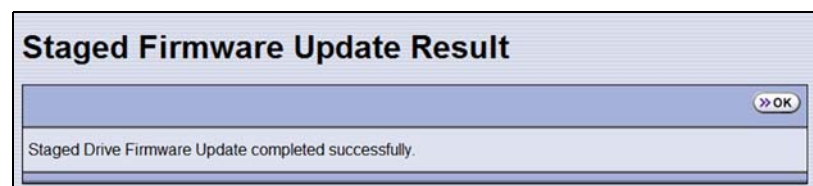

Figure 250 Click **OK** to return to the Drives screen.

5. After the update is complete, use your storage management software to restart any backup processes.

Update Using the Drive Firmware Update Wizard

The Drive Firmware Update wizard lets you use one or more firmware tapes to update multiple drives within a partition, without interrupting normal library operations in other partitions. The updates are performed as a background operation whenever the library determines that one of the drives selected for update is empty.

- Notes:**
- You cannot use a Global Spare drive to replace a failed drive while the library is actively running the Drive Firmware Update wizard in the partition.
 - You cannot use the Drive Firmware Update wizard to update a TS11xx technology drive.

Requirements

- DLM must be enabled (see [Enabling DLM on page 288](#)).
Note: Enabling MLM automatically enables DLM.
- The drives to be updated must be configured in a storage partition.
- The drives to be updated must be offline to the host.
- The firmware update tape must be in a magazine stored in the storage partition's entry/exit pool.
Note: The partition must have entry/exit chambers configured to use this wizard.
- The drives are updated one partition at a time.
- To update the firmware of a Global Spare, first substitute the Global Spare drive for a drive assigned to a partition. After the Global Spare drive completes the firmware update process, it can be removed from the partition and returned to the pool of spare drives (see [Use the Global Spare Drive on page 353](#) for more information).

Discontinue Backups and Empty the Drives

Before beginning the drive firmware update process, you must discontinue all backup operations and remove any cartridges from the drives you are updating.



Caution

Attempting to update the firmware when the drives contain tapes may result in the upgrade failing, failed backup jobs, or permanent damage to the drives. If you did not already do so, stop all backup operations and remove all tapes from the drives you are updating.

- If possible, use your storage management software to move any cartridges that are currently in drives back to their storage locations.
- If you cannot use your storage management software, then move the cartridges as described in [Moving Cartridges Within a Partition on page 231](#).

Import the Firmware Update Tapes

1. Log into the library as a user with superuser or administrator privileges.
2. Insert a firmware update tape into a TeraPack magazine (see [Figure 107 on page 200](#)). Make a note of the barcode label on the cartridge so that you can identify it after it is imported.

Note: If the cartridge is not labeled with a barcode, pay attention to which slot you use (as viewed from the TAP door, slot 1 is at the back of the magazine; slot 10 is at the front).

3. Import the magazine into the library's entry/exit pool as described in [Importing into a Storage or Cleaning Partition on page 202](#).

- Notes:**
- If necessary, export a magazine from the entry/exit pool to provide an empty chamber for the magazine containing firmware update tapes (see [Exporting or Exchanging Magazines and Cartridges on page 209](#)).
 - Some backup software atomically moves tapes from entry/exit slots into the storage partition. If this cannot be disabled in the software or you cannot shutdown the software to prevent this, you cannot use this process.

Perform the Update

1. Select **Configuration**  **DLM** to display the Drives screen.

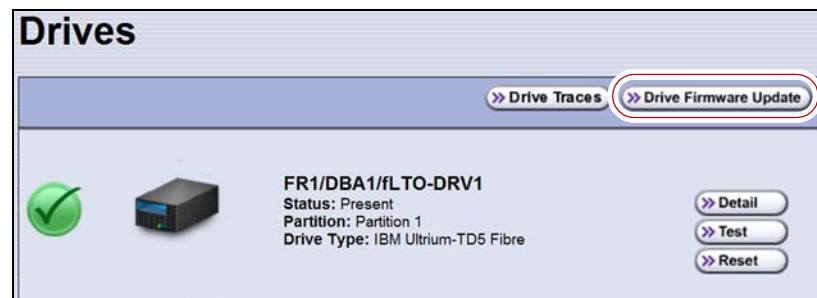

Figure 251 Click **Drive Firmware Update** on the Drives screen.

2. Click **Drive Firmware Update** to launch the update wizard. The Drive Firmware Update screen displays showing the information for the last partition that was viewed.

3. Select the partition containing the drives you want to update from the drop-down list, then click **Go**. The Drive Firmware Update screen refreshes to show the drives assigned to the selected partition.

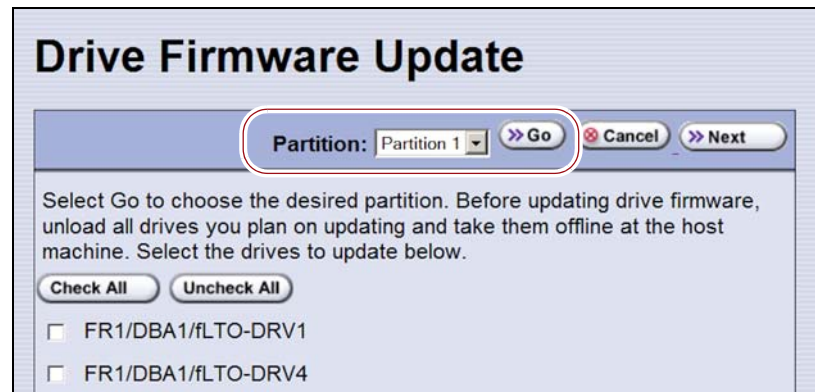

Figure 252 Select the partition for the drives you want to update.

4. Select the drives that you want to update.

! Important

If you have multiple drive generations in the same partition, make sure that you only select one generation at a time. Each drive generation uses different firmware.

5. Click **Next**. The Drive Firmware Update Tape Selection screen displays with a list of the cartridges currently in the entry/exit pool for this partition. Select the firmware tapes you want to use for the update.

! Important

If you have firmware update tapes for multiple drive generations in the same magazine, make sure that you select the firmware update tapes that correspond to the generation of the drives you selected in [Step 4 on page 437](#) or the update fails.



Figure 253 Select the firmware tapes you want to use for the update.

6. Click **Start Update** to begin the background operation to update the selected drives. The Drive Firmware Update screen refreshes to show that the update operation is running.



Figure 254 Drive Firmware Update screen showing an update running.

After each drive is updated, the library posts a system message indicating whether or not the update was successful.

Note: Once the update process begins, you cannot start any additional Drive Firmware Update operations until the currently running process either completes or is stopped.

7. If you need to change the library configuration, modify a partition, or make other changes that are restricted while background operations are running, click **Stop Update**. The library completes any updates that are currently in progress and then returns the firmware tape to the magazine.
8. Export the firmware update tape from the library (see [Exporting or Exchanging Magazines and Cartridges on page 209](#)) and store it for future use.
9. Use your storage management software to restart backup processes.

Update Using the Update Drive Firmware Utility

The Update Drive Firmware utility uses a firmware tape to update a single drive or all of the drives in a single partition.

Note: You cannot use the Update Drive Firmware Utility to update a TS11xx technology drive.

Requirements

- The drives to be updated must be configured in a storage partition.
- The firmware update tape must be in a magazine stored in the storage partition's entry/exit pool.

Note: The partition must have entry/exit chambers configured to use this wizard.

- The drives are updated one partition at a time.
- To update the firmware of a Global Spare, first substitute the Global Spare drive for a drive assigned to a partition. After the Global Spare drive completes the firmware update process, it can be removed from the partition and returned to the pool of spare drives (see [Use the Global Spare Drive on page 353](#) for more information).

Discontinue Background Operations

You cannot update drive firmware if the library is actively running any background operations, including Media Auto Discovery, PreScan, and PostScan.

If you do not want to wait for a Media Auto Discovery, PreScan, or PostScan operation to complete, you can stop the Media Auto Discovery or PreScan operation, or pause the PostScan operation. For other background operations, wait for the process to complete.

- Click **Stop Discovery** on the Media Lifecycle Management Tools screen to stop a Media Auto Discovery or PreScan operation (see [Stop the Discovery Process on page 264](#)).
- Click **Pause PostScan** on the Media Lifecycle Management Tools screen to pause the PostScan operation for one hour (see [Pause the PostScan Process on page 272](#)).

Discontinue Backups and Empty the Drives

Before beginning the drive firmware update process, discontinue all backup operations and remove any cartridges from the drives.



Caution

Attempting to update the firmware while the library is busy or when the drives contain tapes may result in the update failing, failed backup jobs, or permanent damage to the drives. If you did not already do so, stop all backup operations and remove all tapes from the drives you are updating.

- If possible, use your storage management software to move any cartridges that are currently in drives back to their storage locations.
- If you cannot use your storage management software, then move the cartridges as described in [Moving Cartridges Within a Partition on page 231](#).

Import the Firmware Update Tapes

1. Log into the library as a user with superuser or administrator privileges.
2. Insert a firmware update tape into a TeraPack magazine (see [Figure 107 on page 200](#)). Make a note of the barcode label on the cartridge so that you can identify it after it is imported.

Note: If the cartridge is not labeled with a barcode, pay attention to which slot you use (as viewed from the TAP door, slot 1 is at the back of the magazine; slot 10 is at the front).

3. Import the magazine into the library's entry/exit pool as described in [Importing into a Storage or Cleaning Partition on page 202](#).

- Notes:**
- If necessary, export a magazine from the entry/exit pool to provide an empty chamber for the magazine containing firmware update tapes (see [Exporting or Exchanging Magazines and Cartridges on page 209](#)).
 - Some backup software atomically moves tapes from entry/exit slots into the storage partition. If this cannot be disabled in the software or you cannot shutdown the software to prevent this, you cannot use this process.

Perform the Update

1. From the toolbar menu, select **Maintenance**  **Tools**. The Maintenance Tools screen displays.
2. Select **Utilities**. The Utilities screen displays.
3. Click **Show Advanced**. The Advanced Utilities Confirmation screen displays.
4. Click **Next**. The Utilities screen refreshes to show a list of the advanced utilities.
5. Scroll through the list of advanced utilities and select **Update Drive Firmware**. The screen refreshes to show the details for the utility.

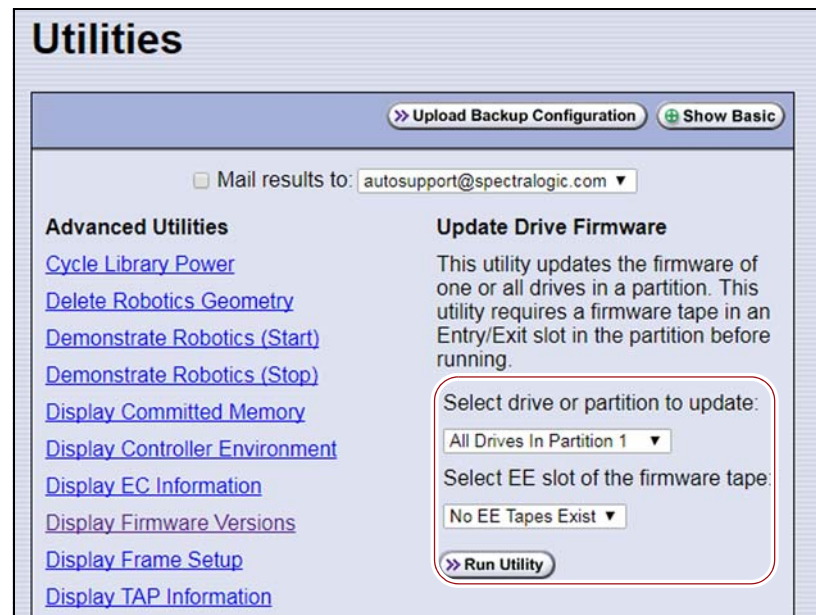

Figure 255 Select the drive to update and the location of the firmware tape.

6. Use the **Select drive or partition to update** drop-down list to select the drive(s) that you want to update. You can choose to:
 - Update all of the drives in a partition.–OR–
 - Update a single drive (selected by its BlueScale identifier).

Note: Drives are identified according to their physical location in the library. For example: FR1/DBA2/DRV4 refers to the upper right drive in DBA2 of frame 1. See [Drive Identifiers on page 57](#) for additional information about identifiers.
7. Use the **Select EE slot of the firmware tape** drop-down list to select the slot in the magazine where the firmware update tape is located.

Note: If you use the wrong firmware tape or try to update a drive that is not compatible with the firmware tape, the update operation fails.
8. Click **Run Utility** to start the update process.

**Important**

- Once the firmware update process starts, it cannot be canceled.
 - Do not power off the library or any component being updated during the firmware update process.
-
- The library retrieves the firmware tape and inserts it into the first drive. When the drive completes the update, it ejects the tape. The library then either returns the tape to the entry/exit pool or inserts it in the next drive to be updated.
 - A progress screen displays for the duration of the update. When completed, a Utility Results screen displays, showing the results of the update process.
9. Repeat the steps, as needed, for the remaining drives in the library.
 10. Export the firmware update tape from the library (see [Exporting or Exchanging Magazines and Cartridges on page 209](#)) and store it for future use. You can use the tape to update the firmware in a replacement drive if it is at a lower firmware level.
 11. Use your storage management software to restart backup processes.

UPDATING DRIVE DEVICE DRIVERS

Overview Some operating environments require you to install device drivers before the application software can correctly communicate with the drives. When you update the drive firmware, you may also need to update the device driver for the drive.

Use the following instructions to locate and download the IBM LTO drive device driver on the IBM Support Fix Central website.

Note: You can connect to the Fix Central website either from the Spectra Logic Technical Support portal or directly at <http://www.ibm.com/support/fixcentral>. If you connect directly, skip to **Step 5** in the following instructions.

1. Log into your account on the Technical Support portal at support.spectrallogic.com

Note: See [Accessing the Technical Support Portal on page 444](#) for information about accessing the Technical Support portal.
2. Select **Downloads**  **Device Drivers**.
3. On the Device Drivers page, click **IBM LTO-2, -3, -4, -5, -6, and -7 (IBM TotalStorage 3580 Ultrium 2, 3, 4, 5, 6, and 7)** to open IBM Fix Central in a new web page.
4. Click the **Select Product** tab.
5. Select the following options:
 - **Product Group** = System Storage
 - **Select from System Storage** = Tape systems
 - **Select from Tape Systems** = Tape drivers and software
 - **Select from Tape drivers and software** = Tape device drivers
 - **Platform** = Select your operating system from the drop-down list and click **Continue**.
6. Click **Continue** to display a list of the available drivers on the Select fixes page.
7. Click **Show Fix Details** to view information about each driver.
8. Select the driver you want to download and click **Continue**. If required by your IT department, select the WHQL certified driver, if available.
9. Complete the remaining pages to begin the download process.
10. Save the file containing the driver to a known location on the server that is using the drive.
11. Install the device driver following the instructions in the documentation for your operating environment.

ADDING OR REPLACING A DRIVE

Only use drives obtained from Spectra Logic in the library. When replacing a drive that is assigned to a partition, the new drive must be the same technology and generation as the one you replace.

Add a Drive to the Library



Important

Adding drives to an existing partition can cause the library to reassign element addresses. To avoid errors, make sure that when you install a new drive, you reconfigure the element addresses your storage management software uses to access the drives (refer to your software documentation for instructions).

If your library has unused drive bays, you can purchase additional drives from Spectra Logic and add them to the library.

1. Log into the library as either a superuser or administrator.
2. Select **Configuration** ➤ **DLM** (or **Drives**) to view a list of all the drives currently installed in the library.

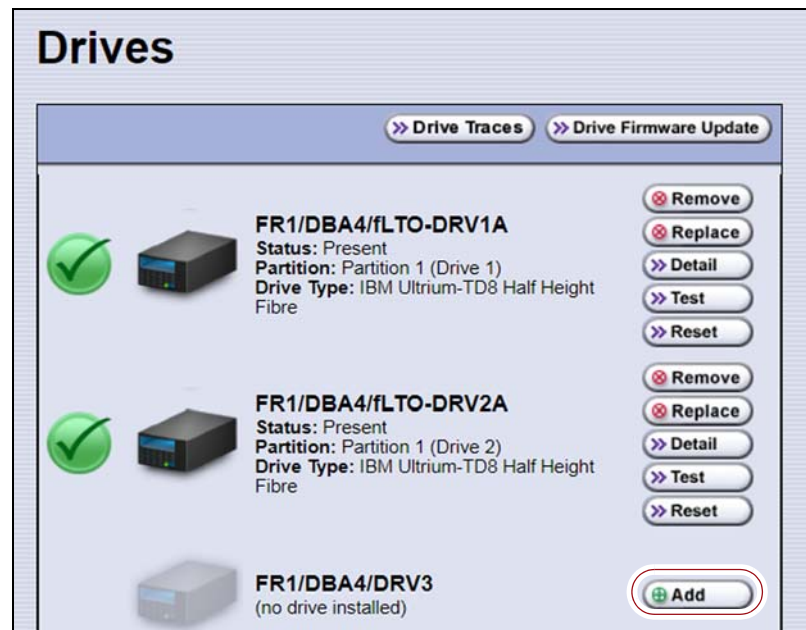

Figure 256 The Drives screen.

3. Click **Add** next to a drive location that does not have a drive installed.
4. Follow the *Spectra T200, T380, T680, T950, and TFinity Drive Installation or Replacement* procedure to install the drive.
5. If the drive has a Fibre Channel interface, connect it to an arbitrated loop or fabric where the hosts reside.

- After you add the drive to the library, you must create or modify a partition to assign it to the partition or configure it as a Global Spare drive before you can use it. See [Chapter 6 – Configuring and Managing Partitions](#), beginning on [page 159](#) for information about creating and modifying partitions.

Replace a Drive

To replace a drive that failed, follow the instructions in the *Spectra T200, T380, T680, T950, and TFinity Drive Installation or Replacement* procedure. Use the cable you disconnected from the failed drive to connect the new drive to a switch on the arbitrated loop or fabric where the hosts that use the drives reside.



Figure 257 The Drives screen.



Important

Do not click Remove. This option removes the drive from the partition. When the replacement drive is installed, it is not assigned to the partition from which the malfunctioning drive was removed.

If you click **Remove** and the selected drive is the only drive in the partition, the partition is deleted.

After you replace the drive, do the following to resume operation:

- If you used the Global Spare option to temporarily replace the malfunctioning drive, you can now reclaim the Global Spare drive so that it is again available for use (see [Undo the Global Spare Drive on page 356](#)). The library automatically switches all incoming communications to the new drive.
- If you did not use the Global Spare option, use your storage management software to restart any backup processes that were running to the replaced drive. This restart ensures that the software recognizes the drive as working and available.

CHAPTER 16

Technical Support

Spectra Logic Technical Support provides a worldwide service and maintenance structure, refined over many years to provide timely, professional service.



Important

A valid BlueScale Software Support key is required in order to obtain technical support (see [Service Contract Extension on page 468](#)).

Topic	
Accessing the Technical Support Portal	this page
Create an Account	page 445
Log Into the Portal	page 447
Opening a Support Ticket	page 447
Returns	page 450

ACCESSING THE TECHNICAL SUPPORT PORTAL

The Spectra Logic Technical Support portal provides access to the Knowledge Base, the current version of BlueScale software for the library, drive firmware, drive device drivers, and additional service and support tools. You can also open or update a support incident and upload ASL files.

Create an Account

Access to User Guides and compatibility matrices does not require you to create an account. You must create a user account and log in to access Release Notes or repair documents, to download the latest version of BlueScale software, or to open a support incident.

Note: If you have multiple Spectra Logic products, the serial numbers for all products are associated with your account. If you do not see the serial numbers for all of your products when you log in, contact Technical Support (see [Contacting Spectra Logic on page 7](#)).

1. Access the Technical Support portal login page at support.spectralogic.com.
2. On the home page, click **Sign up**.

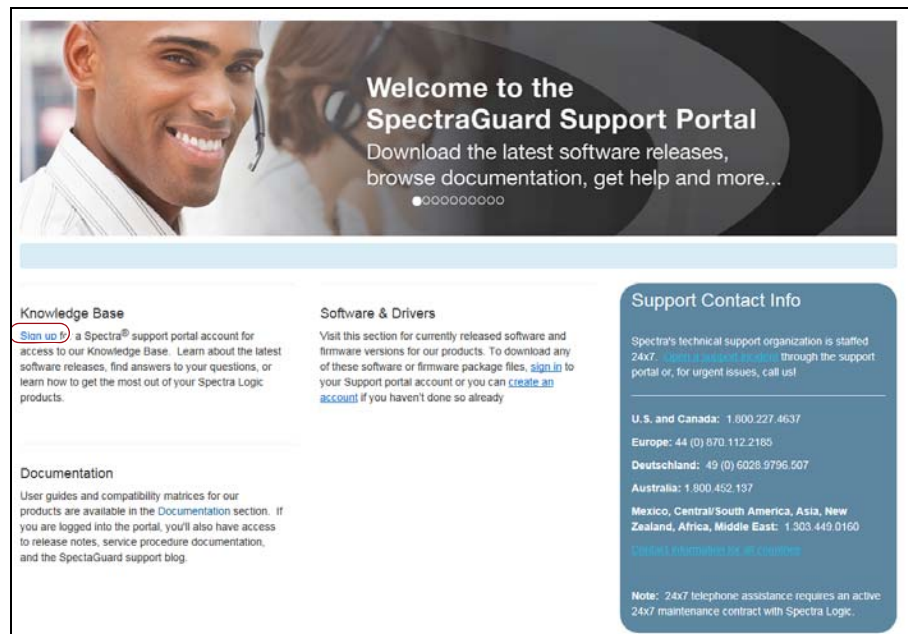

Figure 258 The Spectra Logic Technical Support portal home page.

3. Enter your registration information. Your account is automatically associated with the serial numbers of all Spectra Logic products owned by your site.
 - If you have an invitation, follow the link and enter the invitation code.

Sign Up

Welcome to Spectra Logic's support portal.
Forgot your password? [Retrieve it here.](#)

Have access to an invitation code? [Redeem it here.](#)

Registration Information

First Name * Last Name *

E-mail * Job Title

Business Phone * Mobile Phone

Preferred Method of Contact
Any ▼

Company Details

Company Name

Serial Number/Hardware ID

Street Address

Street Address (line 2)

City *

State/Province

ZIP/Postal Code *

Country/Region *

Figure 259 Follow the link to enter your invitation code or enter your registration information.

- If you do not have an invitation, enter the requested information to create your account. When you are finished, click **Sign Up**.

When the account is approved, you receive an email with an initial password. Use your email address and the password provided in the email to log in to your account. After you log in, you can change your password if desired.

Log Into the Portal

Use your email address and password to log into the Technical Support Portal.

OPENING A SUPPORT TICKET

AutoSupport provides the easiest way to open a support ticket or incident. See [Chapter 11 – Configuring and Using AutoSupport](#), beginning on [page 297](#) for detailed information about configuring and using AutoSupport.

You can also open a support incident using the Spectra Logic Technical Support portal or telephone. Use the following instructions to open a support incident through the portal.

1. Make notes about the problem, including what happened just before the problem occurred.
2. Gather the following information:
 - The serial number of the affected library (see [Determine the Library Serial Number on page 98](#))
 - Type of host system being used
 - Type and version of host operating system being used
 - Type and version of host storage management software being used
3. Submit a support incident.
 - To use the Spectra Logic Technical Support portal:
 - a. Log into your account on the Technical Support portal at support.spectralogic.com.

Note: See [Accessing the Technical Support Portal on page 444](#) if you did not previously create an account on the Technical Support portal.

- b. Select **Incidents & Inventory**  **Open or View Incidents**, or on the Home page, click **Open a Support Incident**.

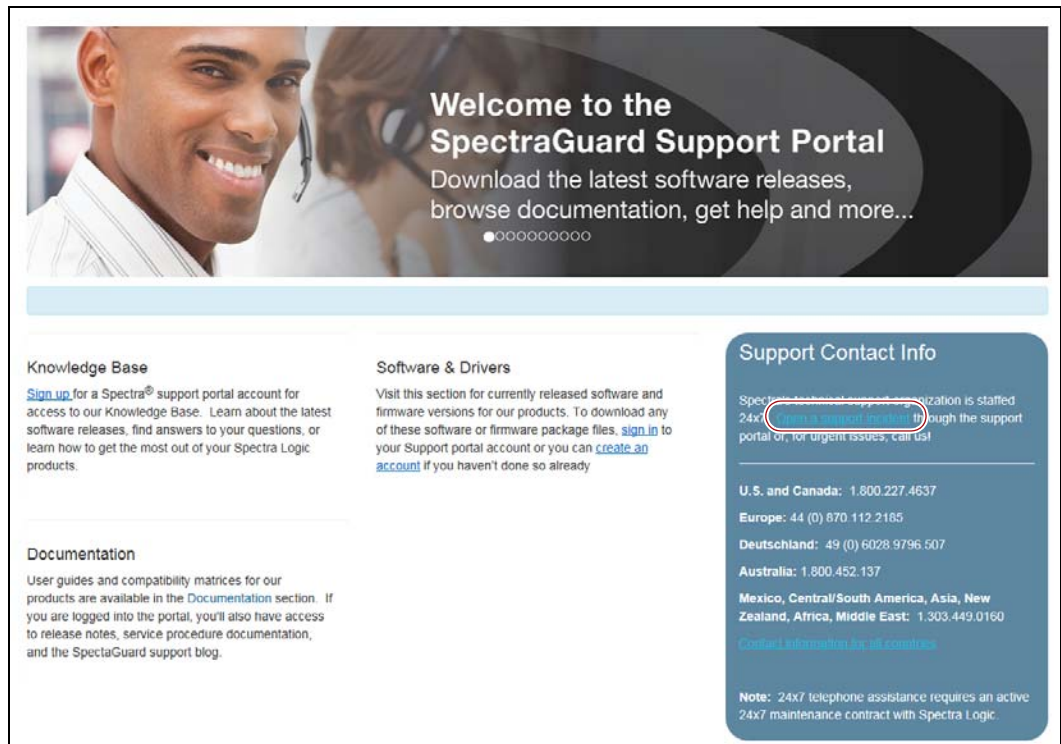

Figure 260 Select **Incidents & Inventory**  **Open or View Incidents** to open a support incident.

- c. On the Open or View Incidents page, you are given an opportunity to search for existing support content that may help you solve your problem immediately. If the search does not provide an answer, click **Open a New Incident**.

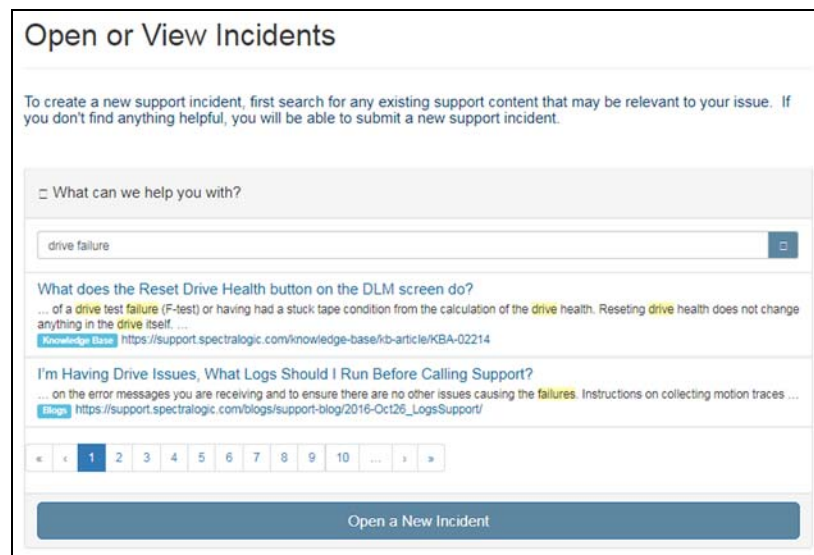

Figure 261 Click **Open a New Incident**.

- d. On the Create Incident page, enter the requested information providing as much detail as possible. When you are finished, click **Create Incident**.

- Notes:**
- If you have multiple libraries and need to determine the serial number of the affected library, see [Determine the Library Serial Number on page 98](#).
 - If the serial number of the affected library is not listed in the **Product** drop down, contact Technical Support (see [Contacting Spectra Logic on page 7](#)).
 - If you do not have AutoSupport enabled, you can upload any ASL logs generated by the library from the Create Incident page.

Create Incident

Support incidents are processed as soon as possible, subject to the terms of your service contract. If you require immediate assistance, please call us instead of submitting a support incident.

To help us best assist you please upload any pertinent logs with an extension up to 90MB.

If your serial number is not listed below in the Product options, please contact SMaSH@spectralogic.com and provide the serial number(s) you need added.

Severity *

Problem Description (Field is public. Do not enter private information such as passwords.) *

Semicolon-separated list of email addresses to include in correspondence

Customer *

Product *

Attach a file (up to 128 MB)

Service Provider Incident #

Create Incident

Figure 262 The Create Incident page.

- To contact Spectra Logic Technical Support by telephone see [Contacting Spectra Logic on page 7](#).

RETURNS

Your Technical Support representative may ask you to return a problem component to Spectra Logic for analysis and servicing. After you complete a replacement procedure, return the defective part using ALL of the packaging that the replacement part arrived in (including any anti-static bags or foam inserts).

**Caution**

Severe damage can occur if the component is not packaged correctly. You may be invoiced if it is damaged due to improper or insufficient packaging.

Use the return label and instructions that were included with the replacement part when preparing to ship the component you are returning. If you cannot locate these, contact Spectra Logic for another copy (see [Contacting Spectra Logic on page 7](#)). The return label and Return Merchandise Authorization (RMA) printed on it are used to associate the returned component with your account. To avoid being invoiced for failure to return the component, do not ship the component back to Spectra Logic without the RMA return label.

APPENDIX A

Best Practices

This appendix reviews best practices for using Media Lifecycle Management, protecting library configuration data, and working with media.

Topic	
MLM Best Practices	this page
Implementation Guidelines	page 453
Usage Policy Guidelines	page 453
Disaster Recovery Planning	page 455
Back Up and Protect the Library Metadata	page 456
Back Up the Library Metadata	page 456
Verify and Protect the Metadata Backup	page 458
Using Cartridges	page 460
Labeling Cartridges	page 460
Handling Cartridges	page 461
Storing Cartridges	page 462
Using Cartridges in the Library	page 463
Cartridge Rotation	page 464

MLM BEST PRACTICES

To effectively use MLM and ensure MLM and DLM data protection, plan a strategy based on your data center needs and develop policies and procedures to support that strategy. Having sound management policies and procedures for media rotation and management is essential for consistent, effective implementation.

Implementation Guidelines

Consider the following best practice guidelines as you prepare to implement MLM in your environment.

Guideline	Description
Identify the people responsible for backing up data	The people who perform data backup at your site are typically the ones who are responsible for implementing and following MLM backup procedures.
Identify the users who have responsibilities that involve MLM	It may be wise to have more than a single user familiar with policies, depending on the size of your organization, so that if one person is not available, another can take over.
Be consistent with partition names	Using consistent naming simplifies identifying a specific partition. Spectra's suggested naming practice is to list the location, followed by the library name, followed by the storage management software. For example, Dallas/T950V/NetBackup.
On an organizational level, determine the level of management your media requires	The level of media management depends on the requirements for your environment. For example, you may choose to use Spectra's guidelines for retirement for all media, or you may choose to retire tapes that hold financial or legal data sooner than recommended. See the Error and Warning health scores in Generate MLM Reports on page 273 for information on when cartridges should be retired.

Usage Policy Guidelines

Consider the following guidelines when establishing your Media Lifecycle Management policies.

Guideline	Description
Choose a retirement guideline	When implementing MLM, decide at the beginning on the criteria to be used when determining when to retire a cartridge. Spectra suggests using the Media Lifecycle Management health icon, visible on the MLM Reports screen and on the Details screen (Figure 143 on page 276 and Figure 144 on page 278 , respectively) for each tape, to assess the overall health of individual tapes. See Generate MLM Reports on page 273 for information about using the health icon to assess media health.
Only use MLM-enabled media and cleaning cartridges in MLM-compatible libraries and drives	For the most accurate tracking, do not import your MLM-enabled media into non-Spectra Logic libraries. Other libraries do not update the cartridge MAM so the information is not recorded in the MLM database when the cartridge is returned to your Spectra library.

Guideline	Description
<p>Use only Spectra Certified Media with MLM support (both data and cleaning cartridges) in the library</p>	<p>To ensure the best possible performance, use Spectra Certified Media. Check the Spectra Logic website for the most up-to-date media availability. Do not use any media that is not approved by Spectra Logic for use in the library.</p> <p>The library uses information in the MLM database to monitor the health of the media in the library. For MLM-enabled media, the detailed health reports let you determine whether a particular data cartridge is past its useful threshold or determine whether a particular cartridge is experiencing high errors rates or retries. For MLM-enabled cleaning cartridges, you are notified when a cartridge is approaching the end of its useful life.</p> <p>Although MLM tracks the general health of media that is not MLM-enabled, detailed health information is not available for this media.</p>
<p>Always operate the library with Media Lifecycle Management enabled</p>	<p>If you disable and then re-enable Media Lifecycle Management, any loads, reads, writes, errors, and any other tape related events that occur while MLM is disabled are not recorded in the MLM database.</p>
<p>Enable load count alerts</p>	<p>Load count alerts, used in combination with the media health icon, let you monitor the health of individual tapes. Tapes with low load counts, but with a yellow or red health icon are vulnerable to high errors rates or retries.</p> <p>For higher levels of notification, configure a threshold for the maximum number of times a data cartridge can be loaded before an alert is generated (see Enable and Configure MLM PreScan and PostScan on page 178). When the number of loads exceeds this threshold, MLM generates a system message listing the barcode of the tape.</p> <p>You can also enable an alert to notify you when the load count recorded on the cartridge MAM differs from the load count stored in the MLM database but none of the other data changed. This type of discrepancy can indicate that the tape was loaded into a non-Spectra Logic library. Use this alert as a security feature to let you know when a tape was removed and loaded into a drive in a different library.</p>
<p>Regularly back up your MLM database</p>	<p>Determine how frequently to export the MLM database for storage. You can save the MLM database to a USB device or email it to a previously configured mail recipient. The database can be loaded back into the library in the event of an error. See Disaster Recovery Planning on page 455 and Restore the MLM and DLM Databases on page 348 for detailed information.</p> <p>Backing up the MLM database produces a point-in-time snapshot of the MLM database. Based on the number of tapes you routinely import into and export from the library, determine how frequently backups are needed to ensure that you can easily restore the MLM database.</p>
<p>Enable non-MLM media alerts</p>	<p>Alerts for non-MLM-enabled media notify you when a cartridge that is not MLM-enabled is loaded into a drive.</p>

Guideline	Description
Track exported cartridges	When a cartridge is exported from the library, an asterisk (*) next to the barcode indicates that it is currently out of the library. However, all of the MLM data for the cartridge is still available. Define the frequency with which you export the complete MLM report and make a note of all exported tapes.
Choose relevant information for saved reports	When you save an MLM report (see Generate MLM Reports on page 273), you can choose between saving all MLM data or just the data from the most recently viewed report. You can save a copy of the MLM report as a comma-separated text file (*.rpt) to a USB device, mail the saved report to previously configured email recipient, or both. If desired, you can zip the file before saving it (see Save an MLM Report on page 278).

Disaster Recovery Planning

As a part of best disaster recovery planning and practices, Spectra Logic strongly recommends backing up the MLM database to a USB device or emailing it to a preconfigured mail recipient automatically after using MLM for some period of time. In the event of a disaster, you can use the backup to restore the MLM database information for the media in your library instead of rebuilding it by loading each cartridge into a drive (see [Restore the MLM and DLM Databases on page 348](#)).



Important

The automatic weekly auto-save file reflects the state of the MLM database at the time the backup was created. If MLM-enabled media is imported into or exported from the library during the period between the automatic weekly auto-save operations, the backup of the MLM database may not accurately reflect the library's inventory.

If you plan to import or export a large number of MLM-enabled cartridges, back up the MLM database using the procedure described in [Back Up the MLM and DLM Databases on page 282](#) when you are finished to ensure that you have a backup that accurately reflects the information in the database.

- Notes:**
- Backing up the MLM database also backs up the DLM database.
 - For extra security, the library's Auto Configuration Save feature automatically backs up its configuration and the MLM and DLM databases to the LCM memory card once a week and whenever a partition is created or modified (see [Use Automatic Backup of the Library Configuration on page 136](#)).
 - If email for the auto-save backup is configured, the backups are emailed to the designated recipient (see [Enable Email for the Auto Configuration Save File on page 108](#)).
 - See [Back Up and Protect the Library Metadata on page 456](#) for additional disaster planning information.

BACK UP AND PROTECT THE LIBRARY METADATA

To ensure the availability of your library and encrypted data, protect library metadata by following the procedures described in this section. Library metadata includes library configuration data, the MLM and DLM databases, and all BlueScale encryption key-related data.

Note: The DLM database is included in any operations that backup or restore the MLM database.

Having reliable backups of the library metadata is *very* important in the case of disaster recovery and other situations where you need to restore the library.



Caution



Losing your library's metadata can have catastrophic effects—as can losing keys in any encryption key management system, especially when related to encrypted data. If you lose all copies of all metadata:

- Your encrypted data is lost—you are unable to decrypt encrypted data without the encryption keys.
- You need to completely reconfigure your library.
- You lose stored data about your media that is time-consuming to recover.

Back Up the Library Metadata

Use the following methods to create backup copies of all of your library's metadata. The following table shows the file names and locations of the data saved during each type of backup operation.

This backup method...	Creates...
Auto Configuration Save Option	<p>A time-stamped zip file containing the library configuration, the MLM database, and the DLM database. The file is stored on the memory card in the LCM and can be sent as an email attachment to a previously configured mail recipient. The zip file is named <code><date-time>cfg.zip</code>, where <code><date-time></code> is the time stamp for when the zip file was created.</p> <ul style="list-style-type: none"> ▪ See Enable Email for the Auto Configuration Save File on page 108 for information about configuring the Auto Configuration Save feature so that the library automatically sends an email with the current Auto Configuration Save file to a pre-configured mail recipient once a week and whenever you create or modify a library partition. ▪ See Use Automatic Backup of the Library Configuration on page 136 for information about using this method to back up the library configuration and the MLM and DLM databases. <p>Note: The Auto Configuration Save feature does not automatically create a backup when you make other configuration changes to the library.</p>

This backup method...	Creates...
Save MLM Database Advanced Utility	<p>A time-stamped file containing the current MLM and DLM databases. The file is saved to a USB device or emailed to a previously configured mail recipient. The filename depends on whether the file is zipped and includes the time stamp <code><date-time></code> to indicate when the backup was created. If the backup file was saved to a USB device, it is located in a folder called <code>\SavedMLMDB</code>.</p> <ul style="list-style-type: none"> ▪ <code>xmlinfo<date-time>.db</code> — OR — ▪ Zippered file — <code>cminfo_<date-time>.zdt</code> <p>Back Up the MLM and DLM Databases on page 282 provides instructions for using the utility.</p> <p> Important: To ensure that you always have a current backup of the MLM and DLM databases, back them up regularly.</p>
Partition Wizard and Save Library Configuration Utility	<p>Multiple configuration files with the format <code>cnnnnnnn.cfg</code>, where <code>n</code> is a number between 0 and 9. You can choose to save the library configuration data to a USB device or email it to a previously configured mail recipient.</p> <ul style="list-style-type: none"> ▪ If the backup files are saved to a USB device, they are located in a folder called <code>SavedConfigs\<date-time></code>, where <code><date-time></code> is the time stamp for when the backup was created. ▪ If the backup was sent as an email attachment, the files are in a file named <code><date-time>cfg.zip</code>, where <code><date-time></code> is the time stamp for when the zip file was created. <p> Important: The backup file of the library configuration does not include the MLM and DLM databases.</p> <p> Important: Backing up the library configuration also backs up any BlueScale encryption keys that are stored in the library at the time the file is created.</p> <ul style="list-style-type: none"> ▪ Partition Wizard — The partition wizard prompts you to save the library configuration whenever you create or modify a partition. See Chapter 6 – Configuring and Managing Partitions, beginning on page 159 for detailed information about creating and modifying partitions. ▪ Save Library Configuration Utility — Use the Save Library Configuration utility to back up the updated library configuration whenever you make a configuration change to the library. This is especially important when you make configuration changes that do not result in an Auto Configuration Save file. See Use Manual Backup of the Library Configuration on page 136 for instructions.

This backup method...	Creates...
Export Key Option	<p>A key file containing the exported BlueScale encryption key. The file is named <i>name</i>.bsk or <i>name</i>.bss, where <i>name</i> is the moniker you assigned to the key when you created it. You can choose to save the exported key file to a USB device or email it to a previously configured mail recipient.</p> <p>Use the BlueScale Export Key option to export BlueScale encryption keys to a USB device as soon as you create them. The exported keys are encrypted and password protected. See the <i>Spectra Tape Libraries Encryption User Guide</i> for instructions.</p> <p> CAUTION: As a matter of best practice, Spectra Logic recommends exporting BlueScale encryption keys to a USB device instead of using email.</p> <p>Although emailing BlueScale encryption keys is supported by the library, doing so presents security issues, including the following:</p> <ul style="list-style-type: none"> ▪ Copies of encryption keys may be left on the email servers used for sending and receiving email and are thus subject to compromise. ▪ The difficulty in verifying where all the copies of emailed encryption keys may be located can make security audits more challenging.

Verify and Protect the Metadata Backup

Do the following to ensure that your metadata is protected and available when you need it:

1. As soon as you create and export the backup files, check the exported data to make sure the correct files are present and accessible.
 - Plug the USB device into a computer or laptop.
 - If you emailed the metadata (the data is sent as an attachment), save the data to a USB device, and then check the data in the email attachment and the data on the USB device.

The following figures show examples of the files you see when you check your USB device or the email attachment./

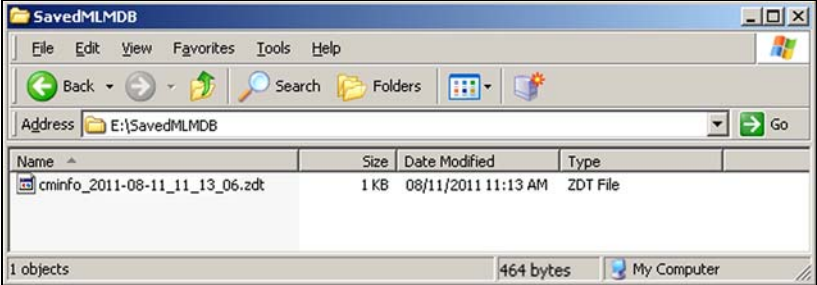
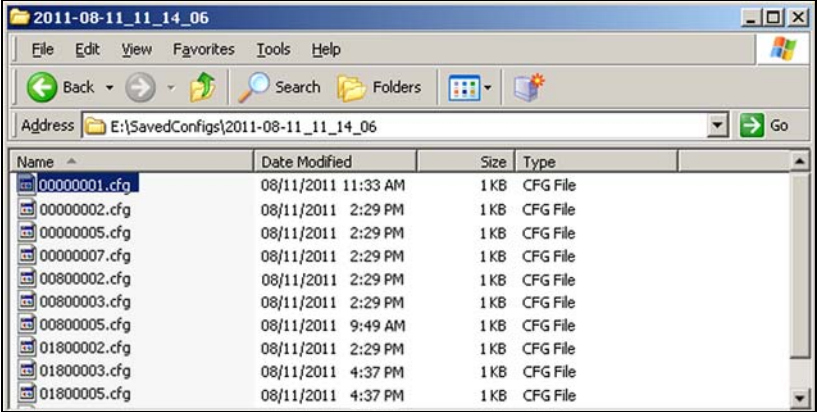
Saved Data	Details
Encryption key (T950_SF2.bsk)	 <p>Note: The screen shown here also includes the SavedMLMDB and SavedConfigs folders.</p>
MLM and DLM data	 <p>Note: In this example the file has a .zdt extension because you chose to zip the file when you created it.</p>
Configuration data	 <p>Note: The files are located in the \SavedConfigs\<>date-time<> folder, where <date-time> in this example is 2011-08-11 11_14_06.</p>

2. Store at least one USB device containing the backup files off-site. After you have several weeks of backups stored off-site, rotate back through them.
3. When you run through disaster recovery exercises, test restoring the library using the backup files from both your USB devices and your saved email attachments. See [Restoring the Library Configuration on page 340](#) for instructions.

USING CARTRIDGES

The following sections describe best practices for using cartridges and for managing your media inventory. All library user groups have privileges that allow them to use the library's user interface to perform the cartridge handling and media management operations described in this appendix. Because handling cartridges requires physical interaction with the library, much of the information in this appendix is not applicable when you are accessing the library using the BlueScale web interface.

Note: See [MLM Best Practices on page 452](#) for additional guidance when using Spectra Certified Media with MLM support.

Labeling Cartridges

If you are not using pre-labeled Spectra Certified Media (both data and cleaning cartridges), be sure to label all cartridges with the appropriate barcode labels. Position each label in the indented area on the cartridge, as illustrated in [Figure 263](#). See [Barcode Label Specifications on page 493](#) for detailed information about preparing and using barcode labels.

**Caution**

Do not place labels on any surface of the cartridge except the area shown in [Figure 263](#). A loose label can become dislodged and damage the drive.

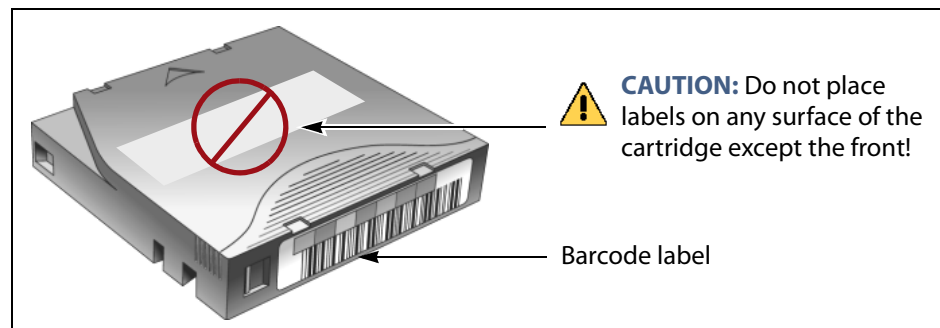

Figure 263 Properly barcode label all cartridges (LTO cartridge shown).

Handling Cartridges

Incorrect handling or an incorrect environment can damage the LTO cartridge or the magnetic tape inside it. To avoid damage to your cartridges and to ensure the continued high reliability of your drives, use the following guidelines:

- Do not drop the cartridge. If the cartridge drops, slide the cartridge door back and ensure that the leader pin is properly seated in the pin-retaining spring clips. Inspect the rear of the cartridge (the part that you load into the tape drive first) and ensure that there are no gaps in the seam of the cartridge case.
- Do not open any part of the cartridge other than the cartridge door. Do not open any other part of the cartridge case. The upper and lower parts of the case are held together with screws; separating them destroys the usefulness of the cartridge.
- Do not handle tape that is outside of the cartridge. Handling the tape can damage the tape's surface or edges, which may interfere with read or write reliability. Pulling on tape that is outside of the cartridge can damage the tape and the brake mechanism in the cartridge.
- If tape is outside of the cartridge, slide the cartridge door back and turn the hub to gently spool the tape back into the cartridge. Test the tape by using your storage management software to write to the tape, and then run a PostScan.
- Before you use a cartridge, let it acclimate for at least 24 hours to the normal operating environment.
- Ensure that all surfaces of a cartridge are dry before inserting it into a magazine.
- Do not stack more than six cartridges.
- Do not expose the tape cartridge to moisture or direct sunlight.
- Do not degauss a tape cartridge that you intend to use/reuse. Degaussing makes the tape unusable.
- Do not expose recorded or blank tape cartridges to stray magnetic fields (such as terminals, motors, video equipment, X-ray equipment, or high-current cables or power supplies). Such exposure can cause the loss of recorded data or make the blank cartridge unusable.
- Maintain the environmental conditions specified in [Tape Media Specifications on page 491](#).

Storing Cartridges

While in use, cartridges are stored in TeraPack magazines inside the library. When the cartridges are *outside* of the library, Spectra Logic recommends storing them in magazines with dust covers.



Figure 264 TeraPack magazines with barcode labeled cartridges and plastic dust cover (LTO magazines shown).

Storing and handling cartridges in magazines helps to eliminate errors resulting from mishandling individual cartridges, which is the leading cause of cartridge damage. An optional clear plastic dust cover snaps onto the magazine to protect the cartridges.

Whenever you remove cartridges from your library, be sure to store them properly to maximize archival life and ensure data integrity. Follow these guidelines for proper cartridge storage:

- Store cartridges in a suitable environment (see [Tape Media Specifications on page 491](#)).
- Keep the storage location as free of airborne particulates as possible. To eliminate obvious sources of particulates, do not permit anyone to smoke, eat, or drink near the storage area, and do not store cartridges near a copier or printer that may emit toner and paper dust.
- Store cartridges with the write-protect switch in the protected position (see [Preparing Cartridges for Use on page 197](#)).
- Store cartridges as soon as possible after you remove them from the library. Immediate storage helps avoid many of the conditions that can damage tapes, such as temperature and humidity fluctuations, particulate contamination, and excessive handling.
- If you plan to ship a TeraPack magazine, make sure that you have a proper shipping container and that you use adequate packing material. The TeraPack carrying cases available from Spectra Logic are designed for safely transporting TeraPack magazines off site and are compatible with Iron Mountain.

Using Cartridges in the Library

This section describes the best practices for using cartridges in the library.

- Use only cartridges from approved vendors in the library. See [Appendix B – Media & Upgrades](#), beginning on [page 467](#) for more information about Spectra Certified Media.
- Make sure that the entry/exit pool contains one or more empty TeraPack magazines. This is particularly important when your storage management software ejects tape cartridges from a partition.

If the entry/exit pool does not have any empty slots available for the ejected media, then the storage management software must wait until empty slots become available. The simplest way to avoid this delay is to import one or more empty TeraPack magazines after you export media from the library.

Alternatively, always make sure that you import full TeraPack magazines into the library, then use your storage management software to move (import) all of the new media into the storage pool for the partition. After all of the media is moved to the storage pool, you will end up with one or more empty magazines in the entry/exit pool.

- Make the entry/exit pool large enough to accommodate all of the cartridges typically imported or exported during a single operation. For example, if you run a nightly backup that uses 48 cartridges which are then exported each morning, create an entry/exit pool of 50 LTO slots (5 chambers) or 54 TS11xx technology slots (6 chambers).
- After your library is in use for a period of time, and at least one set of cartridges completes a round trip (exported from the library, stored off site, then re-imported), the following rule of thumb applies: if you remove a TeraPack magazine from the entry/exit pool, replace it with either an empty magazine to accommodate future eject operations or a full magazine whose cartridges are then imported into the storage pool using your storage management software.
- During an import or export operation, do not leave the library unattended for more than a few minutes. If you do, the import or export operation times out so that the library can continue automated backup tasks. To continue, restart the operation when you are ready.
- Enable Auto Drive Clean and configure a cleaning partition to clean drives whenever required to help ensure optimal performance. If you do not use the Auto Drive Clean feature, periodically check the Drives screen to determine whether the drives require cleaning (see [Cleaning a Drive on page 413](#)).
- Confirm the quality of your media and verify data integrity by occasionally running restores using different drives.
- Confirm the quality of both media and drives by running periodic disaster recovery drills. These drills test the overall ability to recover all of your data using your backups.

Cartridge Rotation

During normal backup operations, tapes are rotated into and out of the library. This section provides a simple example of the library's media life cycle functionality to manage tape rotation. Using a backup plan similar to the one described in the following example for a period of time establishes a media rotation schedule for the library. The example assumes the following:

- The library has a total of 17 licensed chambers and uses LTO media.
 - 2 chambers are assigned to the entry/exit pool (20 slots, or 2 TeraPack magazines).
 - 15 chambers are assigned to the storage pool (150 slots, or 15 TeraPack magazines).
- The library contains 15 full TeraPack magazines and two empty TeraPack magazines.
- Two magazines containing 20 cartridges worth of backup data are sent off site every Friday.
- After the data ages two weeks, the media is returned to the library and re-used.
- The site adheres to the following best practices:
 - Whenever a TeraPack magazine is exported, another magazine (either full or empty) is imported.
 - The library has enough empty TeraPack magazines to fill the entry/exit pool.

This example shows that, by Week 3, the backup plan results in a full media rotation in which the operator performed the following:



1. Removed and stored two full TeraPack magazines of media. Full magazines were exported from the entry/exit pool and removed through the TAP, resulting in an empty entry/exit pool.
2. Imported two full TeraPack magazines into the entry/exit pool through the TAP and then used the storage management software to move the media in the entry/exit pool into the storage pool.

Moving the media to the storage pool leaves two empty magazines in the entry/exit pools, ready to accept media as the storage management software identifies media as ready to be ejected from the library.

The following sections describe and illustrate the rotation process in more detail.



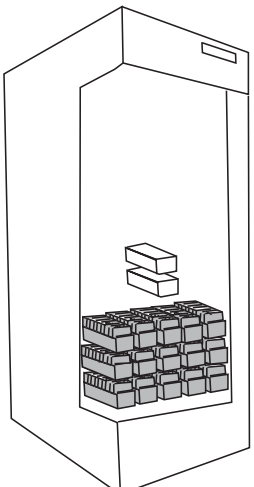

Initial Installation of Cartridges

The library is configured with a single partition and has a total of 17 licensed chambers assigned to either the entry/exit pool or storage pool. When the library is initially installed, chambers are filled with TeraPack magazines as described in the following illustration.

<p>Library:</p> <ul style="list-style-type: none"> ▪ Entry/Exit pool: 2 chambers contain empty TeraPack magazines. ▪ Storage pool: 15 chambers contain full TeraPack magazines. 		<p>Data center: 4 empty TeraPack magazines available.</p> 
--	---	--

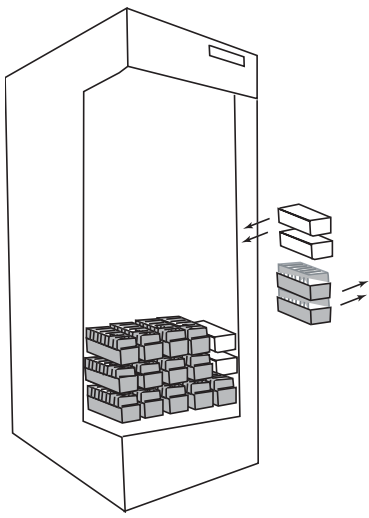

End of Week 1

The storage management software ejects cartridges from the storage pool. The library moves the cartridges to empty magazine slots in the entry/exit pool, making them ready to be removed from the library and stored off site.

<p>Operator tasks:</p> <ul style="list-style-type: none"> ▪ Export 2 full TeraPack magazines from the entry/exit pool. ▪ Import 2 empty TeraPack magazines into the entry/exit pool. 		<p>Results of operator tasks:</p> <p>Off-site storage: 2 full TeraPack magazines.</p>  <p>Entry/Exit pool: 2 chambers, each contains an empty TeraPack magazine.</p>  <p>Storage pool:</p> <ul style="list-style-type: none"> ▪ 13 chambers contain full TeraPack magazines. ▪ 2 chambers contain empty TeraPack magazines.  <p>Data Center: 2 empty TeraPack magazines.</p> 
---	---	--

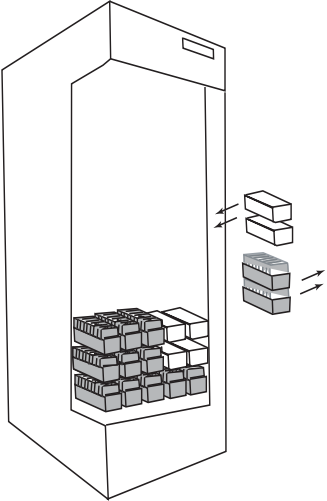

End of Week 2

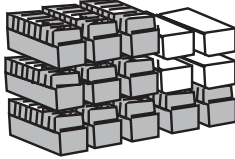
The storage management software ejects cartridges from the storage pool. The library moves the cartridges to empty magazine slots in the entry/exit pool, making them ready to be removed from the library and stored off site.

<p>Operator tasks:</p> <ul style="list-style-type: none"> ▪ Export the 2 full TeraPack magazines from the entry/exit pool. ▪ Import 2 empty TeraPack magazines into the entry/exit pool. 	<p>Results of operator tasks:</p> <p>Off-site storage: 4 full TeraPack magazines</p>  <p>Entry/Exit pool: 2 chambers, each contains an empty TeraPack magazine.</p>  <ul style="list-style-type: none"> ▪ Storage pool: 11 chambers contain full magazines ▪ 4 chambers contain empty TeraPack magazines.  <p>Data Center: No reserved media or magazines.</p>
---	---

End of Week 3

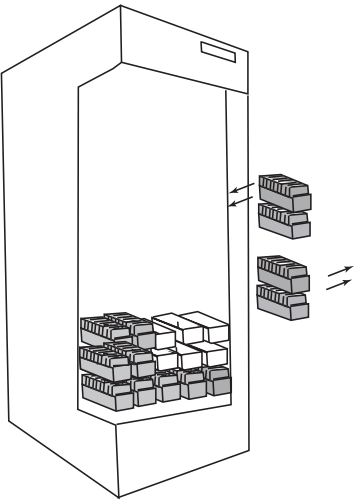
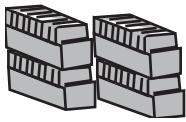
The storage management software ejects cartridges from the storage pool. The library moves the cartridges to empty magazine slots in the entry/exit pool, making them ready to be removed from the library and stored off site. The two full magazines stored off site in Week 1 are ready for re-use. After importing the full magazines into the entry/exit pool, the storage management software is used to move the cartridges to the storage pool, leaving two empty magazines in the entry/exit pool.

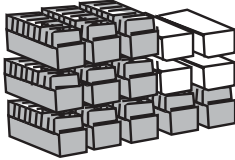
<p>Operator tasks:</p> <ul style="list-style-type: none"> ▪ Export the 2 full TeraPack magazines from the entry/exit pool. ▪ Import 2 full TeraPack magazines into the entry/exit pool. ▪ Use storage management software to move cartridges to the storage pool. 	<p>Results of operator tasks:</p> <p>Off-site storage: 4 full TeraPack magazines</p>  <p>Entry/Exit pool: 2 chambers, each contains an empty TeraPack magazine.</p>  <ul style="list-style-type: none"> ▪ Storage pool: 11 chambers contain full magazines ▪ 4 chambers contain empty magazines  <p>Data Center: No reserved media or magazines.</p>
---	---

APPENDIX B

Media & Upgrades

This appendix describes media, accessories, and upgrades that can be purchased for use with the Spectra T950V library. It also describes how to renew or extend the service contract for the library.

MEDIA AND MEDIA ACCESSORIES

Spectra Logic offers a variety of media and media accessories for the library.

Spectra Certified Media

The library supports LTO-5 and later generation tape media.

Media formulations There are two distinct formulations for LTO media: Metal Particle (MP) and Barium Ferrite (BaFe). LTO-5 media are only available in the Metal Particle formulation. LTO-6 media can be purchased in either the Metal Particle or the Barium Ferrite formulation. LTO-6 drives are designed to run both MP and BaFe media. The two formulations can be used in the same partition. LTO-7 and LTO-8 media is only available in the Barium Ferrite formulation.

TS11xx technology media is only available in the Barium Ferrite formulation.

Certification process Spectra Certified Media begins with the highest quality data cartridges received directly from the manufacturer. During certification, each cartridge is MLM-enabled. In addition, LTO data cartridges undergo the unique CarbideClean process, which removes embedded particles and smooths the imperfections in the tape surface that are a result of the manufacturing process. By cleaning the tape of the debris that exists on all new media, CarbideClean reduces signal loss and excessive tape head wear, thereby increasing the reliability, availability, and longevity of the drives and media.

Barcode labels For your convenience, all Spectra Certified Media is available pre-labeled with sequential barcode labels. Optional custom barcode sequences can be ordered, if desired. Using Spectra sequential pre-labeled media ensures that you will never have to deal with the problem of duplicate barcodes. Spectra Logic's barcode labels carry the same lifetime guarantee that protects each Spectra Certified Media cartridge.

Media Storage Spectra Logic offers both TeraPack magazines and Maintenance TeraPack magazines pre-loaded with Spectra Certified Media data cartridges or cleaning cartridges, respectively. The magazines are available with or without a protective dust cover to protect the cartridges when they are not stored in the library. Empty magazines are also available.

Check the Spectra Logic website at www.spectralogic.com for the most up-to-date media availability.

Media and Media Accessories

Spectra Logic offers the following media and accessories:

Media or Accessory	Description
Certified media packs	Each pack contains one TeraPack magazine filled with Spectra Certified Media (ten LTO data cartridges or nine TS11xx technology data cartridges) with standard barcode labels. The media packs are available with or without a protective dust cover. Note: With the exception of WORM media, all Spectra Certified media is MLM-enabled.
Certified media pack with custom barcode labels	Each pack contains one TeraPack magazine filled with Spectra Certified Media (ten LTO data cartridges or nine TS11xx technology data cartridges) with custom barcode labels. The media packs are available with or without a protective dust cover. You must order a minimum of four custom-labeled packs at a time.
Cleaning cartridges	Spectra Certified cleaning cartridges are available in Maintenance TeraPack magazines containing either five or ten LTO cleaning cartridges, or five or nine TS11xx technology cleaning cartridges. The cleaning cartridges have "CLN" at the beginning of the barcode sequence on their labels. Notes: <ul style="list-style-type: none"> ▪ All Spectra Certified LTO cleaning cartridges are MLM-enabled. The cleaning cartridges are stored in Spectra Maintenance TeraPack magazines, which are identified by unique labels. ▪ TS11xx technology cleaning tapes are always treated as MLM-enabled by the BlueScale software.
Barcode labels (in series of 300)	High-contrast, high-resolution labels for reliable operation. Labels are available either with a standard barcode numbering sequence or with a custom barcode numbering sequence. Barcode labels for cleaning cartridges are also available. The barcode labels for cleaning cartridges have "CLN" at the beginning of the barcode sequence.

Media or Accessory	Description
TeraPack magazines	Empty TeraPack magazines and Maintenance magazines are available. Each magazine holds ten LTO cartridges or nine TS11xx technology cartridges. The magazines are available with or without a protective dust cover.
TeraPack magazine carrying cases	Carrying cases are designed for safely carrying TeraPack magazines off site. Cases are compatible with Iron Mountain.

How To Order

Check the Spectra Logic website at www.spectralogic.com for the most up-to-date media availability.

To purchase Spectra Certified Media and media accessories, contact your sales representative (see [Contacting Spectra Logic on page 7](#)) or use the Spectra Logic online store at shop.spectralogic.com.

LIBRARY SUPPORT AND UPGRADES

The library ships with the service contract and options purchased with the library. You can renew your service contract or purchase more capacity or additional options described in this section at a later date.

Service Contract Extension

Your initial library purchase includes a BlueScale Software Support key that is valid for the duration of the warranty period, or for the duration of any uplifted or extended service contract you purchased with the library, whichever is longer. A valid BlueScale Software Support key is required in order to update the library's BlueScale software and the firmware for library components, and to obtain technical support.



Important

When you renew or extend your service contract, you must generate a new BlueScale Software Support key and enter the new key into the library to allow continued access to updates (see [Enabling BlueScale Software Support, Options, and Upgrades on page 95](#)). If you have questions about your service agreement, contact Spectra Logic Technical Support (see [Contacting Spectra Logic on page 7](#)).

When the original warranty or service contract expires, a renewal contract can be purchased to continue service. Contact Spectra Logic to purchase a renewal contract (see [Contacting Spectra Logic on page 7](#)).

BlueScale Software Updates

Updates to the library's BlueScale software are free of cost to customers who have a current service contract with Spectra Logic Technical Support. When a service contract is renewed, you must generate a new BlueScale Software Support key and enter it into the library to allow continued access to updates. See [Enabling BlueScale Software Support, Options, and Upgrades on page 95](#) for information.



Important

Updating the BlueScale software and the firmware for the library components requires a current service contract with Spectra Logic Technical Support. The BlueScale Software Support key associated with your service contract must be stored in the library by entering it into the System Configuration screen. See [Enabling BlueScale Software Support, Options, and Upgrades on page 95](#) for additional information.

If you have questions about your service agreement, contact Spectra Logic Technical Support (see [Contacting Spectra Logic on page 7](#)).

See [Updating the BlueScale Software and Library Firmware on page 388](#) for update instructions.

Library Upgrades

Upgrades available for purchase include BlueScale software options and library hardware upgrades. You can purchase options and upgrades from your sales representative (see [Contacting Spectra Logic on page 7](#)).

Options

The following table describes the BlueScale software options that are available. See [Enabling BlueScale Software Support, Options, and Upgrades on page 95](#) for information about enabling these options.

Library Option	Description
BlueScale Encryption Standard Edition	BlueScale Encryption Standard Edition, included free on the T950V library, provides a strong, easy to use method of encrypting data using a single key on the library, letting you add encryption without adding complexity. See the <i>Spectra Tape Libraries Encryption User Guide</i> for more information about BlueScale Encryption.
BlueScale Encryption Professional Edition	In addition to the features of the standard edition, BlueScale Encryption Professional Edition supports multiple keys on a library and additional security features so that you can implement more customized data encryption regimens. See the <i>Spectra Tape Libraries Encryption User Guide</i> for more information about BlueScale Encryption.

Library Option	Description
Spectra SKLM Encryption Key Management System	<p>Spectra Security Key Lifecycle Manager (Spectra SKLM) is a centralized key management system that allows you to manage the lifecycle of the encryption keys and security certificates for your library. Spectra SKLM provides role-based access control, based on user privileges, for tasks that range from creating and assigning encryption keys to the backup and restoration of data.</p> <p>See the <i>Spectra Tape Libraries Encryption User Guide</i> for more information about the Spectra SKLM Encryption key management system.</p>
KMIP Encryption Key Management using the HP Enterprise Secure Key Manager (ESKM)	<p>The Key Management Interoperability Protocol (KMIP) using the HP Enterprise Secure Key Manager (ESKM) is a centralized key management system that allows you to manage the lifecycle of the encryption keys and security certificates for your library. The library software uses the HP ESKM server to generate, store, and retrieve security keys used by tape drives for data encryption.</p> <p>See the <i>Spectra Tape Libraries Encryption User Guide</i> for more information about the KMIP Encryption key management.</p>
Capacity-On-Demand (CoD)	<p>The Capacity-On-Demand (CoD) feature lets you purchase a library that meets your current storage needs and then purchase additional capacity later as required. CoD reduces up-front costs, because users only pay for what they currently need. As more capacity is required, it can be added in increments by purchasing activation codes to license additional chambers in the library and additional TeraPack magazines to fill the added chambers.</p> <p>If you purchase CoD capacity that exceeds the number of unlicensed chambers available in the current library configuration, purchase shelves to replace a DBA in an existing frame or an expansion frame. These upgrades and their installation by a certified Spectra Logic field technician are priced separately from the CoD capacity upgrade.</p>
Rotation Manager	<p>Rotation Manager is a keyed option to simplify identifying tapes that were moved off site. With Rotation Manager installed, the library sends an email containing the barcode information for every piece of media and its off-site location to a specified email address.</p> <p>See Configure Rotation Manager on page 133 for additional information about Rotation Manager.</p>
Shared Library Services (SLS)	<p>Shared Library Services (SLS) partitioning logically divides the library into multiple virtual libraries. With SLS, one library can support multiple media types and provide dedicated library services to multiple user groups. The default library configuration includes support for a single storage partition. If you need additional storage partitions, you must purchase a Shared Library Services (SLS) activation key.</p> <p>See Library Partitions on page 50 for more information about using partitioning in the library using SLS.</p>

Hardware Expansion and Upgrades

The Spectra T950V library is designed to expand to meet changing storage requirements, as well as to achieve storage consolidation goals. These expansion and upgrade options can be purchased through a sales representative (see [Contacting Spectra Logic on page 7](#)).

The following table describes the types of hardware expansion and upgrades that are available.

Hardware	Description
Drive Bay Assembly (DBA)	<p>If all of the currently installed DBAs in the library are fully populated with drives and your library includes shelves in the back of a main or drive frame, you can replace shelves with a DBA.</p> <p>Note: Replacing shelves with a DBA reduces the storage capacity of your library.</p>
Shelves	<p>If all of the currently installed chambers in the library are fully populated with TeraPack magazines and your library includes more than one Drive Bay Assembly (DBA), you can replace a DBA with shelves .</p> <p>Note: Replacing a DBA with shelves can reduce data throughput.</p>
Drives	<p>Each Drive Bay Assembly (DBA) holds up to four drives. If a DBA is not full, additional drives can be installed to increase data throughput.</p> <p> Important: Do not attempt to install drives purchased from other vendors in the library. The drives used in the library are specifically configured for use in the library and must be purchased from Spectra Logic.</p>
Expansion Frames	<p>The storage capacity or performance of the library can be increased by adding media or drive expansion frames, respectively.</p> <p>See Drive and Media Frames on page 54 for information about the number and types of expansion frames that can be added to the library.</p>
Power Supplies	<p>The library requires a minimum of one 5/12 VDC power supply module per populated DBA. It also requires a minimum of one 24 VDC robotics power supply module in the main frame. Optionally, you can purchase an additional supply per frame, which in combination with the dual AC power inputs, provides redundancy and failover protection. The power supply modules needed for the power redundancy configuration are an option you can purchase separately or when you order the library.</p>
Robotics Interface Module (RIM)	<p>A RIM2 can be used to provide the robotic control path for a partition. One RIM2 can support up to 16 partitions.</p> <p>Two or more RIM2s are required if you want to use the BlueScale controller failover feature for enhanced availability.</p>
USB Device	<p>You can use a USB device for saving backups of the library configuration and MLM database, when you are updating the library's BlueScale software, or as a troubleshooting tool for use as instructed by Spectra Logic Technical Support. USB devices are available for purchase from Spectra Logic for a nominal charge.</p> <p>Note: The library only recognizes FAT-formatted, not NTFS-formatted, USB devices.</p>

How to Order

To purchase library upgrades, including a renewed or extended service contract, determine your library Hardware ID (see [Determine the Library Serial Number on page 98](#)) and then contact your sales representative (see [Contacting Spectra Logic on page 7](#)).

REPLACEABLE COMPONENTS

Some library components are easy to remove and install. They are classified as customer-replaceable units (CRUs) and they are available for purchase based on your service contract with Spectra Logic Technical Support (see [Chapter 16 – Technical Support, beginning on page 444](#)). CRUs include:

- Drives
- RIM2s
- Library Control Module (LCM)
- Robotics Control Module (RCM)
- Power supply modules
- Power Control Module (PCM)
- Transporter (not the VAX column)
- Memory card in an LCM or RCM

Depending on your service contract, you may also be able to replace certain additional components that are classified as field-replaceable units (FRUs).

APPENDIX C

Specifications

This appendix provides specifications for the Spectra T950V library, as well as the drives and media used in the library:

Topic	
Library Specifications	page 474
Data Storage Capacity	page 474
Size and Weight	page 477
Service Access Requirements	page 478
Shipping and Storage Size and Weight	page 478
Power Specifications	page 479
Environmental Specifications	page 482
Shock and Vibration Specifications	page 484
Interoperability and Software Compatibility	page 484
Interface Specifications	page 484
Component Interface Connectors	page 485
Network Interface Cable Requirements	page 485
Universal Serial Bus (USB) Support	page 486
NDMP Support	page 486
Tape Drive and Media Specifications	page 486
LTO Tape Drive Specifications	page 486
TS11xx Technology Tape Drive Specifications	page 489
Drive-Based Encryption Highlights	page 490
Tape Media Specifications	page 490
Barcode Label Specifications	page 492

Notes: ■ The specifications in this chapter are subject to change without notice.

- Discontinued components are not included in this chapter. See [The modular design makes it possible to increase media storage capacity or number of drives in the library to meet storage and performance needs as they evolve within an organization. Additional expansion frames can be added to the basic single-frame T950V library to increase the tape slot and drive capacities. See \[Drive and Media Frames on page 54\]\(#\) for more information. on page 47 for additional information.](#)

LIBRARY SPECIFICATIONS

The following sections provide detailed specifications for the library including data storage capacity, library size and weight, space requirements, power specifications, environmental specifications, and shock and vibration specifications.

Data Storage Capacity

The T950V library provides flexible storage capacity that expands from a minimum of one media pack up to the maximum storage capacity of the library. The capacity specifications in this section assume that only one type of drive and media is installed in the library. When using mixed drives and media, the library's capacity depends on the number of frames in the library, the number of drives and slots inside each frame, and the type(s) of drives and media used. See [Drive and Media Frames on page 54](#) for an explanation of the different types of frames that can comprise the library.

T950V Main Frame

The following tables show the capacity of the T950V main frame in its available configurations.

Frame Type T950V Main - LTO	Maximum Number of Drives	Number of Chambers (Slots) ^a	Native Capacity (TB)				
			LTO-5	LTO-6	LTO-7	LTO-M8	LTO-8
▪ 1 DBA/shelves	4	100 (1000)	1500	2500	6000	9000	12000
▪ 3 DBAs/shelves	12	92 (920)	1380	2300	5520	8280	11040
▪ 6 DBAs	24	80 (800)	1200	2000	4800	7200	9600

a. A chamber contains a TeraPack magazine with 10 slots.

Frame Type T950V Main - TS11xx Technology	Maximum Number of Drives	Number of Chambers	Number of Slots ^a	Native Capacity (TB)		
				TS1140 Technology	TS1150 Technology	TS1155 Technology
▪ 1 DBA/shelves	4	82	738	2952	7380	11070

Frame Type T950V Main - TS11xx Technology	Maximum Number of Drives	Number of Chambers	Number of Slots ^a	Native Capacity (TB)		
				TS1140 Technology	TS1150 Technology	TS1155 Technology
▪ 3 DBA/shelves	12	76	684	2736	6840	10260
▪ 6 DBA	24	66	594	2376	5940	8910

a. A chamber contains a TeraPack magazine with 9 slots.

Expansion Frames

The capacity of an expansion frame depends on the type of frame and its configuration. For each expansion frame, add the frame's capacity to that of the main frame to calculate the capacity of the entire library.

Frame Type LTO Libraries	Maximum Number of Drives	Number of Chambers (Slots)	Native Capacity (TB)				
			LTO-5	LTO-6	LTO-7	M8	LTO-8
Drive expansion	12	107 (1070)	1605	2675	6420	9630	12848
▪ 3 DBAs/shelves							
▪ 6 DBAs	24	89 (890)	1335	2225	5340	8010	10680
Media expansion	None	130 (1300)	1950	3250	7800	11700	15600

Frame Type TS11xx Technology	Maximum Number of Drives	Number of Chambers	Number of Slots ^a	Native Capacity (TB)		
				TS1140 Technology	TS1150 Technology	TS1155 Technology
Drive expansion	12	90	810	3240	8100	12150
▪ 3 DBAs/shelves						
▪ 6 DBAs	24	75	675	2700	6750	10125
Media expansion	None	110	990	3960	9900	14850

a. A chamber contains a TeraPack magazine with 9 slots.

Size and Weight

The following table shows the size and weight specifications for the library frames and other components.

- All dimensions and weights are approximate.
- To calculate the approximate weight of a loaded library, calculate the total weight for all of the frames and then add the weight for each drive, RIM, and power supply, plus the weight of each TeraPack magazine full of cartridges.
- To calculate the dimensions of the entire library, total the dimensions for each frame and add 1.625 inches to account for the outer cover panels on each side of the library.
- When calculating space requirements, include the service access requirements described in [Service Access Requirements](#), below.

Parameter	Main Frame	Drive Expansion Frame	Media Expansion Frame
Height ^a	79.125 to 82 in. (201.0 to 208.3 cm)		
Width ^b	29 in. (73.7 cm)		
Depth	43.25 in. (109.9 cm)		
Weight ^c	6D: 895 lb (406 kg) 3D: 876 lb (397 kg)	6D: 720 lb (327 kg) 3D: 750 lb (340 kg)	538 lb (244 kg)
Each tape drive	<ul style="list-style-type: none"> ▪ LTO-6: 11.6 lb (5.3 kg) ▪ LTO-7: 11.2 (5.1 kg) ▪ LTO-8: 11.0 (5.0 kg) ▪ TS11xx technology: 17.5 lb (8 kg) 		N/A
Each TeraPack magazine	<ul style="list-style-type: none"> ▪ with ten LTO cartridges: 5.1 lb (2.3 kg) ▪ with nine TS11xx technology cartridges: 5.6 lb (2.5 kg) 		
Each RIM	5.0 lb (2.3 kg)		N/A
Each power supply	4.0 lb (1.8 kg)		N/A
Fully loaded maximum weight	6D: 1,648 lb (748 kg) 3D: 1,535 lb (696 kg)	6D: 1,510 lb (685 kg) 3D: 1,447 lb (656 kg)	1,201 lb (545 kg)

a. The height of each frame can be adjusted to allow frame-to-frame leveling on uneven floors.

b. These dimensions represent the frames without the side cover panels installed. The outermost frame on each end of the library has a single side cover panel. Each side cover panel adds 1 inch to the width of the frame.

c. These weights are with no drives, RIMs, power supplies, or media installed.

Service Access Requirements

Recommended clearance Providing 3 ft (0.9 m) of clearance on each side of the library is highly recommended.

Minimum Clearance A minimum of 2 ft (0.6 m) of clearance is required on the left and right ends of the library to provide service access to the library. If data center equipment is on rolling racks and can be easily moved to provide 2 ft (0.6 m) of clearance on each end of the library, then having equipment adjacent to the ends of the library is acceptable. In addition, a minimum of 2 ft (0.6 m) of clearance is required for airflow and service and operator access.



Important Providing 3 ft (0.9 m) of clearance on each side of the library is highly recommended.

Refer to the *Spectra T950V Library Site Preparation Guide* for detailed information about space and access requirements.

Shipping and Storage Size and Weight

The following table provides the approximate dimensions and weights of the pallet and boxes used to ship the library.

	Height	Width	Depth	Weight ^a
Crated Frame ^b	7.2 ft (2.2 m)	3.5 ft (1.1 m)	4.6 ft (1.4 m)	1,200 to 1,300 lb (544 to 590 kg)
Crated VAX Column ^c	8 ft (2.4 m)	2.6 ft (0.8 m)	2.1 ft (0.6 m)	200 lb (91 kg)
Crated HAX Rail ^c				
▪ 2-frame	6.1 ft (1.9 m)	2.3 ft (0.7 m)	1.0 ft (0.3 m)	110 lb (50 kg)
▪ 3-frame	7.7 ft (2.3 m)	3.0 ft (0.9 m)	1.4 ft (0.4 m)	150 lb (68 kg)
▪ 5-frame	12.5 ft (3.8 m)	1.8 ft (0.5 m)	0.7 ft (0.2 m)	120 lb (54 kg)
▪ 6-frame	15.0 ft (4.6 m)	1.8 ft (0.5 m)	1.1 ft (0.3 m)	120 lb (54 kg)
▪ 8-frame ^d	7.3 ft (2.2 m)	2.0 ft (0.6 m)	1.4 ft (0.4 m)	85 lb (39 kg)
Component Pallet ^e	1.8 to 5.0 ft (0.6 to 1.5 m)	3.5 to 14.9 ft (1.1 to 4.6 m)	1.8 to 5.0 ft (0.6 to 1.5 m)	200 to 400 lb (91 to 181 kg)

a. The weight does not include drives, media, RIMs, transporter, or power supply modules.

b. Each frame is shipped in a separate crate.

c. A single frame library ships with the VAX column and HAX rail installed in the frame.

d. Shipped in a palletized package rather than a crate.

e. The size and weight of the component pallet depends on the number and type of components shipped. To calculate the approximate weight of all the components, add the weights for the drives, TeraPack magazines, RIMs, and power supplies listed in [Size and Weight on page 477](#). Components may also be shipped individually.

Power Specifications

This section describes the power specifications for the library. For information about the different types of AC power modules, see [Dual AC 2 Power Module on page 36](#).

Input Power Requirements

The main frame and drive expansion frames include dual AC power modules. When using a redundant power configuration, connect each input on the dual AC power module to a separate branch circuit, which allows for failover in the event of a power failure in one of the circuits.

Each library frame is rated at 200–240 VAC at 13 amps (2600 watts maximum). This power rating is based on a main frame with 24 LTO drives and 6 RIMs, which is the configuration for maximum power consumption by a single frame. The frames are *not* rated at 120 VAC due to the high current required to supply the product.

Power Cord Specifications

The power cords included with the library are considered part of the library and are not intended for use with any other equipment. See [Supply-End Connector Types on page 480](#) for the different types of cords available from Spectra Logic.

- Notes:**
- The supply-end connector is considered the disconnect for the unit. Make sure that the socket-outlet for the AC connection is in an accessible location near the library.
 - The power cord must meet the specifications for the country where the library is to be installed.

North America and Korea 200–240 VAC Power Cord The criteria for a 200-volt to 240-volt AC power cord in North America and Korea are as follows:



Parameter	Specification
Power cordage	SJT type, three-conductor, 14 AWG minimum
Power input connectors	<ul style="list-style-type: none"> ▪ Male: Connector must be of the proper type, rating, and safety approval (see Supply-End Connector Types on page 480). ▪ Female: IEC 60320 C19

International 200–240 VAC Power Cord The criteria for an international 200-volt to 240-volt AC power cord are as follows:

Parameter	Specification
Power cordage	Flexible, HAR (harmonized) type H05VV-F, three conductor, cord with minimum conductor size of 1.7 square millimeters (0.0026350 square inches).
Power input connectors	<ul style="list-style-type: none"> ▪ Male: Connector must be of the proper type, rating, and safety approval for the intended country (see Supply-End Connector Types on page 480). ▪ Female: IEC 60320 C19

Supply-End Connector Types

The supply-end connector on the cord depends on the country where the library is to be installed. The following table shows the supply-end connector types used in each country.

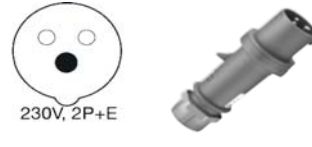
Part Number	Country of Use	Plug Style	Length	Appearance
9594	North America, Korea	NEMA L6-20P	14.8 ft (4.5 m)	
7029	North America, Korea	NEMA L6-30P	14.8 ft (4.5 m)	
6807	Japan	NEMA L6-20P	13.9 ft (4.25 m)	
8665	United Kingdom, Continental Europe	IEC 60309	15 ft (4.6 m)	 <p>230V, 2P+E</p>

Grounding Requirements

Due to electromagnetic interference (EMI) filtering in each dual AC power supply, the leakage current for main frames and drive frames is such that they require a secure connection from the frame chassis to an earth ground.

Use one of the following methods for securing a ground connection when installing a main frame or drive frame:

Note: Cord lock brackets and cords with locking connectors are not compatible and cannot be used simultaneously.

- Add cord lock brackets (Spectra Logic part number 5497) to all drive frames. See [Installing Cord Locks on page 409](#) for more information.
- Use a cord with locking connectors at both ends, such as L6 20P to locking C19 (Spectra Logic part number 9594).

Power Consumption and Cooling Requirements

The power and cooling requirements for the library depend on the number and type of drives installed. The following table provides the maximum power consumption and heat load for the base library and for each additional component added to the base library. Use this information to calculate the total maximum power consumption and heat load values, which can be used to build a power budget for the library.

All values are measured at the AC input and include power supply efficiency. The values are averages of observed hardware. In general, the lighter the load on the power supplies, the less efficient they are. The power supply efficiency in turn affects the power draw of all components.

Component	Power Consumption (watts)	Heat Load, Continuous (BTU/hour)
Main frame ^a	183	625
Drive frame ^a	139	475
Media frame in frame location 2 through 6	110	376
Media frame in frame location 7 or 8	14	48
5/12 VDC power supply	33	113
24 VDC power supply	29	99
RIM2	12	41
LTO-8 Fibre Channel Full-Height	<ul style="list-style-type: none"> ▪ Read/write: 40 ▪ Idle: 15 ^b 	Read/write: 136
LTO-8 Fibre Channel or SAS Half-Height	<ul style="list-style-type: none"> ▪ Read/write: 43 ▪ Idle: 14 ^b 	Read/write: 164

Component	Power Consumption (watts)	Heat Load, Continuous (BTU/hour)
LTO-7 Fibre Channel Full-Height	<ul style="list-style-type: none"> ▪ Read/write: 31 ▪ Idle: 20^b 	Read/write: 106
LTO-7 Fibre Channel or SAS Half-Height	<ul style="list-style-type: none"> ▪ Read/write: 31 ▪ Idle: 20^b 	Read/write: 106
LTO-6 Fibre Channel	<ul style="list-style-type: none"> ▪ Read/write: 28 ▪ Idle: 8^b 	Read/write: 95
TS1155 technology	<ul style="list-style-type: none"> ▪ Read/write: 60 ▪ Idle: 19^b 	Read/write: 205
TS1150 technology	<ul style="list-style-type: none"> ▪ Read/write: 55 ▪ Idle: 38^b 	Read/write: 188

a. Assumes one 5/12 volt power supply and one 24 volt power supply; no drives or RIM2s installed.

Environmental Specifications

This section describes environmental specifications for the library. Do not place the library on a carpeted floor or anywhere else that poses risk for static discharge that could damage the library and its drives.



Caution

The library must be installed on a level, hard-surfaced floor such as cement or tile. Never install it on carpeted flooring.

The library is equipped with internal fans that operate as much as is necessary for the number of DBAs installed. The fans keep the library's internal temperature within specifications as long as the data center environment is within specifications.



Caution

When the library is moved from a cold environment to a warm environment, it should not be powered on for at least 24 hours. This adjustment period prevents condensation damage.

The following tables list the general environmental specifications for the library.

Operating Environmental Specification	
Humidity	20% to 80% (non-condensing)
Humidity gradient	Less than 10% per hour
Ambient temperature	LTO: 50° F to 90° F (10° C to 32° C) TS11xx Technology: 61° F to 90° F (16° C to 32° C)
Maximum temperature change rate ^a	18° F per hour (10° C per hour), non-condensing
Maximum wet bulb temperature	77° F (25° C)
Altitude	Sea level to 10,000 ft (3,048 m)

- a. The temperature and humidity must be allowed to acclimate in the specified ambient environment for 24 hours.

Storing ^a and Shipping (Non-Operating) Environment Specification	
Humidity	10% to 95% (non-condensing)
Temperature	–40° F to 149° F (–40° C to 65° C)
Altitude	Sea level to 40,000 ft (12,192 m)

- a. The library is in its original packaging. The packaging is designed to protect the library from condensation caused by extreme temperature variations of 27° F (15° C) or more. When the library is moved from a cold storage environment to a warm operating environment, it must be acclimated in its packaging for at least 24 hours before opening to prevent serious condensation damage from occurring.

Shock and Vibration Specifications

The library operates normally after experiencing shock loads as specified in the following table. The operating shock levels indicate how much shock the library can withstand while the enclosed drives are reading and writing data. The non-operating and storage shock levels indicate how much shock the library can withstand when it is not operating. After experiencing this amount of shock, the library continues to operate normally.

Specification	Operating	Storing and Shipping (Non-Operating Environment) ^a
Shock	2 g pk ½ sine wave for 10 msec (3 axes, 2 shocks per axis, minimum)	2 g pk ½ sine wave for 10 msec (3 axes, 2 shocks per axis, minimum)
Vibration (Swept Sine)	5 Hz – 500 Hz – 5 Hz 5 – 22 Hz, 0.01-inch DA displacement 22 – 500 Hz, 0.25G pk @ ½ octave (minimum three axes)	5 Hz – 500 Hz – 5 Hz 5 – 31 Hz, 0.02-inch DA displacement 31 – 500 Hz, 1G pk @ ½ octave (minimum three axes)
Vibration (Random)	0.5 Grms, 0 – 3000 Hz (single axis)	1 – 200 Hz @ 1.156 Grms. Bottom face only for 60 minutes.

a. Specifications are for the library in its original packaging.

INTEROPERABILITY AND SOFTWARE COMPATIBILITY

You can find complete interoperability listings, as well as a list of the types of software that were tested and proven compatible with the library on the Spectra Logic website at www.spectralogic.com/compatibility.

INTERFACE SPECIFICATIONS

This section provides information about the interfaces used to connect the library and tape drives to the host systems. It also provides information about the Ethernet interface used to access the library's BlueScale web interface.

The Robotics Interface Module (RIM) supports a Fibre Channel host interface. Direct-attached tape drives have a native Fibre Channel or SAS interface.

For information about how IBM drives support Fibre Channel communications, refer to the tape drive documentation, available from IBM at www.storage.ibm.com/tape/lto/oem/index.html.

Component Interface Connectors

Component	Physical Interface
Drive, Fibre Channel	Two dual port multimode optical LC connectors for full-height drives and one for half-height drives. ^a
Drives, SAS	Two dual-port, 6 Gb/second connectors that conform to the Device Free (Plug) connector form of the SFF-8088 standard “Unshielded Dual Port Serial Attachment Connector” as defined by the SFF standards body.
RIM, Fibre Channel	Two dual port optical SFPs with LC connectors

a. Only one port at a time can be used to connect the drive to a Fibre Channel network. If desired, the two ports can be used to create a failover configuration.

Network Interface Cable Requirements

The type of cables required to connect the library and its drives to the network depend on the type of interface being used.

Interface Type	Cable Requirements
Fibre Channel (RIMs and drives)	<p>The Fibre Channel interface in the RIMs and Fibre Channel tape drives support the Fibre Channel Protocol (FCP). Connecting these components to the host network requires multimode optical cables with dual LC connectors.</p> <p>Depending on the wavelength, the cables must comply with the following specifications in the Fibre Channel standard (FC-P1-2):</p> <ul style="list-style-type: none"> ▪ 50 micron — 400-M5-SN-I classification ▪ 62.5 micron — 400-M6-SN-I classification (not supported for LTO-6, LTO-7, LTO-8, or TS11xx technology drives)
Ethernet	<p>The Ethernet port on the LCM provides a 10/100/1000BaseT connection to an Ethernet network for accessing the library using a standard web browser on a remote computer.</p> <p>Each Ethernet port is a pin-through-hole RJ-45 shielded connector. To comply with EMC requirements, use shielded Category 5 or 5e data-grade cables for all Ethernet connections.</p>
Serial Attached SCSI (SAS)	<p>SAS tape drives support the point-to-point Serial Attached SCSI protocol. Connecting these drives to the host network requires a SFF-8088 SAS cable rated for 6 Gb/second that does not exceed 13 feet (4 m).</p>

Universal Serial Bus (USB) Support

Spectra Logic supports using the USB ports on the library operator panel, the LCM, and the RCM for the following:

- Keyboards
- Pointer devices (for example, a computer mouse)
- External Drives (HD, CD, DVD, and Flash) with a USB interface

Spectra Logic does not support using the USB ports for the following:

- Cameras
- Multimedia devices (for example, MP3 players)



Important The library only recognizes FAT-formatted, not NTFS-formatted, USB devices.

NDMP Support

Spectra Logic tape libraries are compatible with local, remote, and three-way NDMP (Network Data Management Protocol) topologies, where the tape library is connected to the NDMP data mover host over Fibre Channel.

TAPE DRIVE AND MEDIA SPECIFICATIONS

This section provides the basic specifications for the tape drives and media supported by the library.

Note: The specifications in this section are provided for convenience only. Refer to the tape drive documentation for the most current specifications (see [LTO Ultrium Tape Drives on page 20](#) and [TS11xx Technology Drives on page 20](#)).

LTO Tape Drive Specifications

This section provides specifications for the LTO drives supported by the library. See [Tape Media Specifications on page 490](#) for information about the media used in the library.

Note: LTO drives and media are also referred to as Ultrium or LTO Ultrium drives and media.

LTO-8 Drive

When connecting to a Fibre Channel network, LTO-8 Fibre Channel drives will attempt to connect at 8 Gb/second, but will auto-negotiate down to 4 Gb/second, or 2 Gb/second, depending on the requirements of the port to which the drive is connected.

LTO-8 SAS drives attempt to connect at 6 Gb/second, but auto-negotiate down to 3 Gb/second or 1.5 Gb/second, depending on the requirements of the port to which the drive is connected.

Parameter	Specification
Maximum sustained transfer rate ^{a, b}	360 MB/second, native 750 MB/second, compressed
Speed matching range	112 MB/second to 360 MB/second
Average space record time	59 seconds
Encryption capability	AES 256-GCM
WORM capability	Yes
MTBF	250,000 hours at 100% duty cycle
Uncorrected error rate, calculated	1×10^{-19} bits
Power consumption	Read/write: 40 watts typical Idle: 15 watts

a. Assuming a 2.5:1 compression ratio. Compression throughput depends on the type of data.

b. This is a per-drive value. Total sustained transfer rate for the library depends on the number of drives installed in the library.

LTO-7 Drive

When connecting to a Fibre Channel network, LTO-7 Fibre Channel drives attempt to connect at 8 Gb/second, but auto-negotiate down to 4 Gb/second, or 2 Gb/second, depending on the requirements of the port to which the drive is connected.

LTO-7 SAS drives attempt to connect at 6 Gb/second, but auto-negotiate down to 3 Gb/second or 1.5 Gb/second, depending on the requirements of the port to which the drive is connected.

Parameter	Specification
Maximum sustained transfer rate ^{a, b}	300 MB/second, native 750 MB/second, compressed
Speed matching range	100 MB/second to 300 MB/second
Average space record time	56 seconds
Encryption capability	AES 256-GCM
WORM capability	Yes

Parameter	Specification
MTBF	250,000 hours at 100% duty cycle
Uncorrected error rate, calculated	1×10^{-19} bits
Power consumption	Read/write: 31 watts typical Idle: 20 watts

a. Assuming a 2.5:1 compression ratio. Compression throughput depends on the type of data.

b. This is a per-drive value. Total sustained transfer rate for the library depends on the number of drives installed in the library.

LTO-6 Drive

When connecting to a Fibre Channel network, LTO-6 Fibre Channel drives attempt to connect at 8 Gb/second, but auto-negotiate down to 4 Gb/second, 2 Gb/second, or 1 Gb/second, depending on the requirements of the port to which the drive is connected.

Parameter	Specification
Maximum sustained transfer rate ^{a, b}	160 MB/second, native ^c 400 MB/second, compressed
Speed matching range	40 MB/second to 160 MB/second
Average space record time	77 seconds
Encryption capability	AES 256-bit
WORM capability	Yes
MTBF	250,000 hours at 100% duty cycle
Uncorrected error rate	1×10^{-17} bits
Power consumption	Read/write: 28 watts typical Idle: 8 watts

a. Assuming a 2.5:1 compression ratio. Compression throughput depends on the type of data.

b. This is a per-drive value. Total sustained transfer rate for the library depends on the number of drives installed in the library.

c. A 1.5 Gb interface speed does not stream an LTO-6 drive at 160 MB/second.

TS11xx Technology Tape Drive Specifications

This section provides specifications for the TS11xx technology drives.

Note: The specifications in this section are provided for convenience only. Refer to the tape drive documentation for the most current specifications (see [TS11xx Technology Drives on page 20](#)).

TS1155 Technology Drive

Parameter	Specification
Maximum sustained transfer rate ^{a, b}	360 MB/second, native 700 MB/second, compressed
Speed matching range	JD: 112 MB/second to 365 MB/second JC (Gen 5 format): 99 MB/second to 303 MB/second JC (Gen 4 format): 90 MB/second to 252 MB/second
Average file access time	55 seconds
Encryption capability	AES 256-GCM
WORM capability	Yes
MTBF	237,000 hours at 100% duty cycle
Uncorrected error rate	1×10^{-20} bits
Power consumption	Read/write: 60 watts maximum Idle: 19 watts

a. Assuming a 2.5:1 compression ratio. Compression throughput depends on the type of data.

b. This is a per-drive value.

TS1150 Technology Drive

Parameter	Specification
Maximum sustained transfer rate ^{a, b}	360 MB/second, native 700 MB/second, compressed
Speed matching range	JD: 112 MB/second to 365 MB/second JC (Gen 5 format): 99 MB/second to 303 MB/second JC (Gen 4 format): 90 MB/second to 252 MB/second
Average file access time	55 seconds
Encryption capability	AES 256-GCM
WORM capability	Yes
MTBF	237,000 hours at 100% duty cycle
Uncorrected error rate	1×10^{-20} bits
Power consumption	Read/write: 46 watts maximum Idle: 22.3 watts

a. Assuming a 2.5:1 compression ratio. Compression throughput depends on the type of data.

b. This is a per-drive value.

Drive-Based Encryption Highlights

Key AES-256 data encryption with a secret 256-bit encryption key is used to encrypt and decrypt data. The key is not retrievable from the encryption core and is automatically erased during the unload process; software is required to extract the key, keep it secure, and provide management tools to track, store, use, and delete keys as appropriate.

Note: Spectra SKLM key management, KMIP encryption, and BlueScale encryption are not compatible with each other. Data encrypted using one type of encryption key management cannot be decrypted using another. For more information about encryption, see the *Spectra Tape Libraries Encryption User Guide*.

Tape Media Specifications

This section provides specifications for the tape media supported by the library. See [Media and Media Accessories on page 467](#) for information about ordering media for your library.

Environmental Requirements

The following table lists the specifications for storage temperature and other environmental requirements for tape media. Do not allow the temperature and humidity in the storage environment to fluctuate.

Specification	Operating ^a	Operational Storage	Archival Storage	Shipping ^b
Temperature	LTO: 50° F to 113° F (10° C to 45° C) TS11xx technology: 61° F to 90° F (16° C to 32° C)	61° F to 90° F (16° C to 32° C)	61° F to 77° F (16° C to 25° C)	–9° F to 120° F (–23° C to 49° C)
Relative humidity	10% to 80%	20% to 80%	20% to 50%	5% to 80%
Wet bulb temperature	79° F (26° C)	79° F (26° C)	79° F (26° C)	79° F (26° C)

a. The upper limit applies to the media, not the library. Be sure there is adequate air flow around the library at all times.

b. When media is moved from a cold shipping/storage environment to a warm operating environment, it must be acclimated in its packaging for at least 24 hours before opening to prevent condensation damage from occurring.

LTO Media Specifications

The following table shows the capacities of the different generations of LTO Ultrium data cartridges.

LTO Media Generation	Native Capacity (Compressed Capacity)
LTO-5 and LTO-5 WORM	1.5 TB (3 TB ^a)
LTO-6 and LTO-6 WORM	2.5 TB (6.25 TB ^b)
LTO-7 and LTO-7 WORM	6 TB (15 TB ^b)
LTO-M8 ^c	9 TB (22.5 TB ^b)
LTO-8 and LTO-8 WORM	12 TB (30 TB ^b)

a. Assuming a 2:1 compression ratio. The compressed capacity depends on the type of data.

b. Assuming a 2.5:1 compression ratio. The compressed capacity depends on the type of data.

c. See [M8 Media on page 200](#) for more information.

LTO Read/Write Compatibility

The following table shows the media read/write compatibility for each LTO drive generation supported by the library.

Drive Generation	LTO-5 Media	LTO-6 Media	LTO-7 Media	LTO-8 and M8 Media
LTO-6	Read/write	Read/write	Not supported	Not supported
LTO-7	<i>Read only</i>	Read/write	Read/write	Not supported
LTO-8	Not supported	Not supported	Read/write	Read/write

TS11xx Technology Media Specifications

The following table shows the capacities of TS11xx technology cartridges.

Media Generation	Native Capacity (Compressed Capacity ^a)
TS1140 technology and TS1140 technology WORM	4 TB (10 TB)
TS1150 technology and TS1150 technology WORM	10 TB (25 TB)
TS1155 technology and TS1155 technology WORM	15 TB (37.5 TB)

a. Assuming a 2.5:1 compression ratio. The compressed capacity depends on the type of data.

WORM Media

Certain records retention and data security applications require a Write Once, Read Many (WORM) method for storing data on tape. Drives enable WORM support when a WORM tape cartridge is loaded into the drive.

WORM Media Requirements Because standard read/write media are incompatible with the WORM feature, a specially formatted WORM tape cartridge is required. Each WORM cartridge has a unique, worldwide cartridge identifier (WWCID), which comprises the unique CM chip serial number and the unique tape media serial number.

Data Security on WORM Media Certain built-in security measures help ensure that the data written on a WORM cartridge does not become compromised, for example:

- The format of a WORM tape cartridge is unlike that of standard read/write media. This unique format prevents a drive that lacks WORM-capable firmware from writing on a WORM tape cartridge.
- When the drive senses a WORM cartridge, the firmware prohibits the changing or altering of user data already written on the tape. The firmware keeps track of the last appendable point on the tape.

Cleaning Cartridges

Cleaning cartridges are valid for 50 uses. Do not rewind and reuse the material in a cleaning cartridge. Reusing the material may redistribute contaminants previously removed from the tape path. If all of the cleaning material is used, discard the cartridge and use a new cleaning cartridge.

Barcode Label Specifications

Symbology The barcode labeling scheme used on Spectra Logic certified media uses the barcode symbology of USS-39. You can obtain a complete description and definition of this symbology from the *Automatic Identification Manufacturers (AIM) specification*, the *Uniform Symbol Specification (USS-39)*, and the *ANSI MH10.8M-1993 ANSI Barcode specification*.

Application and Orientation The barcode label must be applied to the cartridge so that it fits within the label recess on the edge of the cartridge without curling up on the sides or ends. The label must be oriented so that the barcode characters are along the edge closest to the hub side of the cartridge.

Printed Characters The label can have human-readable alphanumeric characters printed along the top or bottom edge of the label provided there is no conflict or interference with the automation code. This text must include the barcode data, but can also include additional text. The format and colors of the human readable characters is up to the customer and label vendor. For location restrictions, see [Detailed Specifications for LTO Cartridge Barcodes on page 494](#) and [Detailed Specifications for TS11xx Technology Cartridge Barcodes on page 495](#).

Note: When using barcode labels with alphanumeric characters along the bottom edge, the label must be positioned so that barcode is at least 13.72 mm below the top edge of the cartridge to ensure that the barcode reader can read the label.

Barcode Data The library supports barcode data strings consisting of from 1 to 16 characters, including an optional checksum character. Quiet zones precede and follow the start and stop characters.

The barcode data string on standard Spectra Logic barcode labels consists of a start character, eight alphanumeric characters, a checksum character, and the stop character. Quiet zones precede and follow the start and stop characters.

- The first six (6) characters following the start character can be any combination of upper case A-Z or 0-9 (for example, ABC123) to identify the cartridge Volume Serial Number. The use of “CLN” and “DG{space}” at the beginning of the volume identifier is reserved.
- The volume identifier “CLN vnn ” is reserved for cleaning cartridges. When a drive requires cleaning, it requests a specific type of cleaning cartridge.
 - The “ v ” field is an alphanumeric field to identify cleaning cartridge applications, “U” for Universal Cleaning Cartridges or a drive unique identifier.
 - The “ nn ” alphanumeric field is used to track individual cleaning cartridge activity (that is, usage and life).
- The volume identifier “DG{space} vnn ” is reserved for diagnostic and service cartridges.
- The last two (2) characters are the media identifier and indicate the cartridge Media Type (for example, “L” for LTO and “6” for an LTO-6 cartridge or JC for a TS11xx technology cartridge). In IBM LTO tape drives, the value of the media identifier on cleaning cartridges is ignored, although a valid value must be present.
- The barcode string can be printed in either direction on the label and must begin and end with a valid start/stop character (*).
- The label must be printed so that barcode data is positioned along the edge of the label that is closest to the hub side of the cartridge.

The *AIM Uniform Symbol USS-39* specification provides detailed information about the format of the start character, the series of characters that make up the barcode data, the optional checksum character, and the stop character.

Detailed Specifications for LTO Cartridge Barcodes

Figure 265 shows the dimensional specifications for LTO labels with the alphanumeric characters above the barcode.

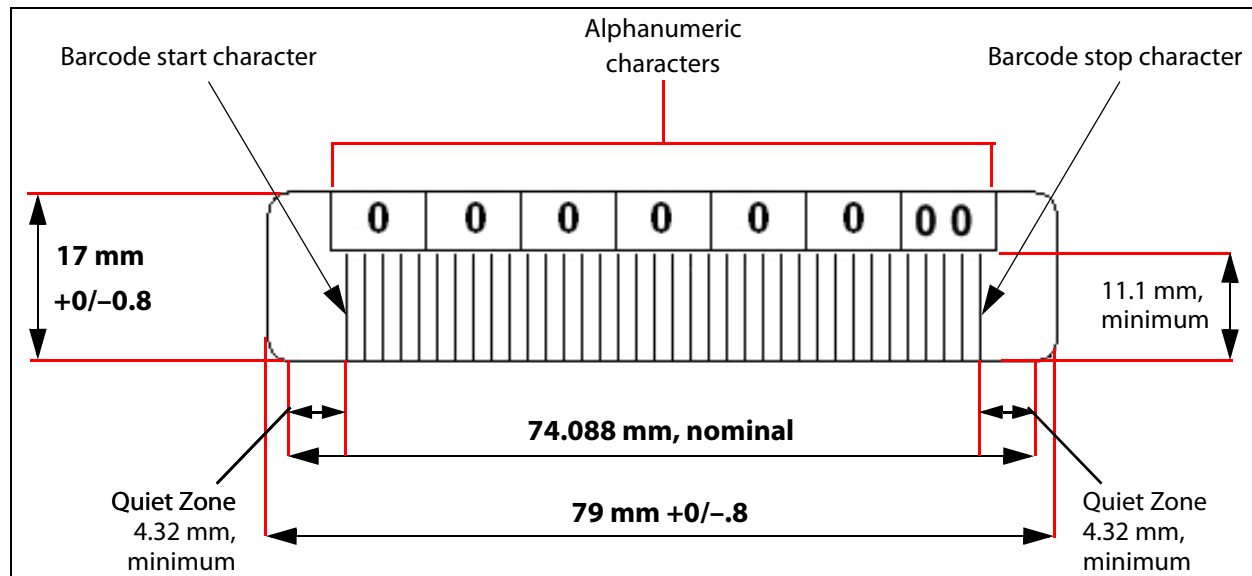

Figure 265 Barcode specifications for LTO media; alphanumeric characters on top.

Note: When using barcode labels with alphanumeric characters along the bottom edge, the label must be positioned so that barcode is at least 13.72 mm below the top edge of the cartridge to ensure that the barcode reader can read the label.

LTO Barcode Element Specifications

For the official IBM barcode label specification, see www-01.ibm.com/support/docview.wss?uid=ssg1S7000429. Unless otherwise specified, tolerances are X.XXX ± 0.127 mm, X.XXX ± 0.762 mm.

- Minimum symbol height is 11.1 mm, measured to the inside of the label's edge.
- The wide-to-narrow ratio is 2.75.
- The narrow element width is 0.432 mm +0.03 mm or -0.076 mm.
- The nominal width of the wide spaces and bars is 1.188 mm.
- The inter-character gap is 0.432 mm +0.03/-0.076 mm.
- The minimum quiet zone at the beginning and end of a printed barcode string is 4.32 mm (10 times the narrow element width).
- The total nominal barcode string length (including quiet zones) is 74.088 mm.
- The edge of the barcode is the edge of the printed area associated with the bar. The edge roughness is the transition encountered as a horizontal line is moved vertically from all black to all white. The edge roughness maximum is 0.038 mm.
- Variation between all bars, white and black, must be less than ±0.0381 mm.

LTO Physical Label Specifications

- Label stock must fit within the label recess on the face of the cartridge without curling up on the sides or ends (79 mm X 17 mm +0/-0.8).
- Minimum length sufficient for the quiet zones, start-stop, and data characters (nominal 74.088 mm).
- Minimum width no less than 1.5 mm narrower than the cartridge label recess width. Corners are cut with a 1.5 mm radius.
- Maximum label thickness, including the RFID tag, if present, together with any associated layers and adhesives cannot exceed 0.40 mm.
- The label and adhesive must have an environmental performance to match or exceed the environmental specifications of the cartridge to which it is applied.

Detailed Specifications for TS11xx Technology Cartridge Barcodes

Figure 266 shows the dimensional specifications for TS11xx technology labels with the alphanumeric characters above the barcode.

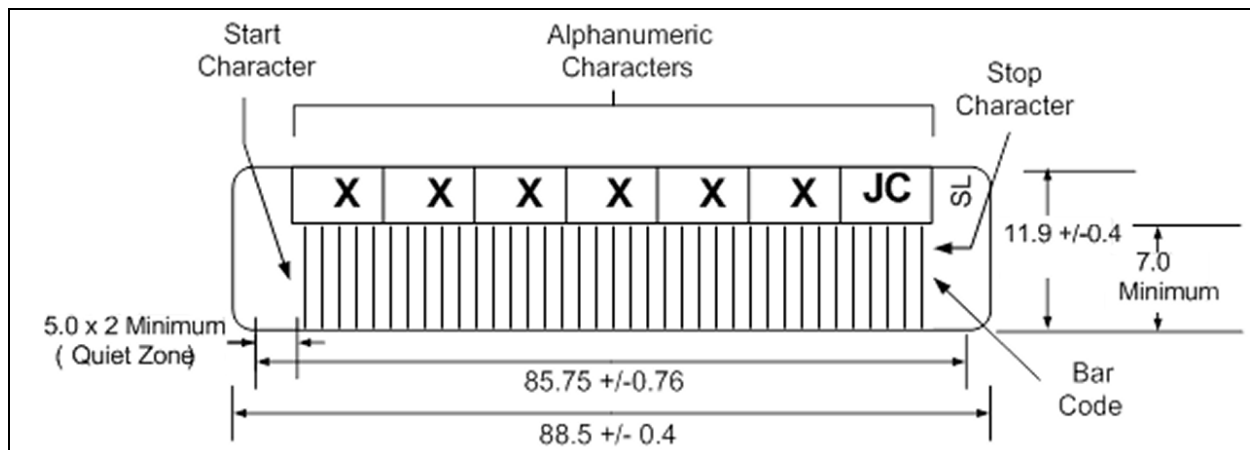

Figure 266 Barcode specifications for TS11xx technology media; alphanumeric characters on top. All measurements are in millimeters.

Note: When using barcode labels with alphanumeric characters along the bottom edge, the label must be positioned so that barcode is at least 13.72 mm below the top edge of the cartridge to ensure that the barcode reader can read the label.

TS11xx Technology Barcode Element Specifications

For the official IBM barcode label specification, see <https://www-304.ibm.com/support/docview.wss?uid=ssg1S7000727>. Unless otherwise specified, tolerances are $X.XXX \pm 0.127$ mm, $X.XX \pm 0.76$ mm.

- Minimum symbol height is 7.1 mm, measured to the inside of the label's edge.
- The wide-to-narrow ratio is 2.75.
- The narrow element width is $0.500 \text{ mm} + 0.03/- 0.07$ mm.
- The nominal width of the wide spaces and bars is 1.375 mm.
- The inter-character gap is $0.500 \text{ mm} + 0.03/- 0.07$ mm.
- The minimum quiet zone at the beginning and end of a printed barcode string is 5.0 mm (10 times the narrow element width).
- The total nominal barcode string length (including quiet zones) is 85.75 mm.
- The edge of the barcode is the edge of the printed area attached to the bar. The edge roughness is the transition encountered as a horizontal line is moved vertically from all black to all white. The edge roughness maximum is 0.04 mm.
- Variation between all bars, white and black, must be less than ± 0.04 mm.

TS11xx Technology Physical Label Specifications

- Label stock must fit within the label recess on the face of the cartridge without curling up on the sides or ends ($88.5 \text{ mm} \times 11.9 \text{ mm} +0/-0.4$).
- Minimum length sufficient for the quiet zones, start-stop, and data characters (nominal 85.75 mm).
- Minimum width no less than 1.5 mm narrower than the cartridge label recess width. Corners are cut with a 1.5 mm radius.
- Maximum label thickness, including the RFID tag, if present, together with any associated layers and adhesives cannot exceed 0.75 mm.
- The label and adhesive must have an environmental performance to match or exceed the environmental specifications of the cartridge to which it is applied.

APPENDIX D

Regulatory & Safety Standards

The Spectra T950V library complies with the safety and regulatory agency standards listed below when installed by a Spectra Logic certified engineer or third-party provider.

EU DECLARATION OF CONFORMITY

According to ISO/IEC 17050-1:2004

Manufacturer's Name: Spectra Logic Corporation

Manufacturer's Address: 6101 Lookout Road, Boulder CO,80301

Declares under sole responsibility that the product as delivered

Product Name: T950V

Model Number: TFinity, T950, T950e

Product options: This declaration covers all options of the above product(s)

Complies with the essentials of the following European Directives, and carries the CE marking accordingly:

Safety	Electromagnetic Compatibility	Restriction of the use of certain hazardous substances
Directive: 2014/35/EU	Directive 2014/30/EU	EN 50581-2012
EN 60950-1:2006 +A11:2009 +A1:2010 +A12:2011 +A2:2013	EN55032: 2012, Class A	(EC)1907/2006 REACH
	EN55024: 2010	2011/65/EU RoHS
EN 62479:2010	EN 61000 3-2:2014	2012/19/EU WEEE
	EN 61000 3-3:2013	

Nicole Gallego

Senior Director of Manufacturing and Quality Operations

EMISSION STANDARDS

The Spectra T950V library complies with the following domestic and international emission standards.

Country	Standard
United States - FCC	CFR Title 47, FCC Part 15 (see FCC Notice)
Australia/New Zealand	AS/NZS CISPR 32: 2015
Canada	ICES-003
Japan	VCCI
Korea	KN 22
Taiwan	CNS 13438

FCC NOTICE

This equipment has been tested and found to comply with the limits for a Class A digital device, pursuant to CFR 47, Part 15 of the FCC Rules. These limits are designed to provide reasonable protection against harmful interference when the equipment is operated in a commercial environment. This equipment generates, uses, and can radiate radio frequency energy, and, if not installed and used in accordance with the instruction manual, may cause harmful interference to radio communications. Operation of this equipment in a residential area is likely to cause harmful interference, in which case the user will be required to correct the interference at the user's own expense.

SAFETY STANDARDS AND COMPLIANCE

Product Safety Standards The Spectra T950V library complies with the following domestic and international product safety standards.

- Directive: 2014/35/EU
- EN 60950-1:2006 +A11:2009 +A1:2010 +A12:2011 +A2:2013
- EN 62479:2010
- CAN/CSA C22.2 No. 60950-1-03 (Canada: cNemko Mark)

Laser Warning

IBM Tape Drives

A Class 1 laser assembly, in the optical transceiver, is mounted on each IBM tape drive Fibre Channel electronics card. This laser assembly is registered with the DHHS and is in compliance with IEC825.

These products contain components that comply with performance standards that are set by the U.S. Food and Drug administration. This means that these products belong to a class of laser products that do not emit hazardous laser radiation. This classification was accomplished by providing the necessary protective housings and scanning safeguards to ensure that laser radiation is inaccessible during operation or is within Class 1 limits. External safety agencies have reviewed these products and have obtained approvals to the latest standards as they apply to this product type.

Spectra Logic RIM Controllers

The optical transceiver is a Class 1 Laser Product as defined by the international standard IEC 60825-1:1993+A1:1997+A2:2001 and by USA regulations for Class 1 products per CDRH 21 CFR 1040.10 and 1040.11. Laser emissions from Class 1 laser products are not considered hazardous when operated according to product specifications. Operating the product with a power supply voltage exceeding 4.0 volts may compromise the reliability of the product, and could result in laser emissions exceeding Class 1 limits.

NEMKO ACCREDITATION

The safety issues of this information technology equipment type have been evaluated by a government-accredited European third-party organization, such as Nemko.

This Mass Storage Device has been evaluated and determined to comply with the Safety Requirements of the International Standard for Information Technology Equipment, IEC/EN 60950-1, Second Edition. The evaluation was conducted by Nemko. Nemko participates in the CB Scheme as a National Certification Body certified by the IECEE.

ENVIRONMENTAL REGULATIONS

The Spectra T950V library complies with the following domestic and international environmental regulations and directives.

Waste of Electronic and Electrical Equipment (WEEE) Directive

Note: For information on recycling your Spectra library, please check the Spectra Logic website. European Union users should contact their local waste administration for WEEE collection instructions for this product.

The WEEE symbol on the back of this product indicates that this product meets the European Directive 2012/19/EU on Waste Electrical and Electronic Equipment, known as the WEEE directive. This directive, only applicable in European Union countries, indicates that this product should not be disposed of with normal unsorted municipal waste.



Within participating European Union countries, special collection, recycling, and disposal arrangement have been established for this product. At the end of life, the product user should dispose of this product using special WEEE collection systems. These special systems mitigate the potential affects on the environment and human health that can result from hazardous substances that may be contained in this product.

Restriction of Hazardous Substances in Electrical and Electronic Equipment (RoHS)

The RoHS marking indicates that this product is in compliance with European Council Directive 2011/65/EU RoHS, on the restriction of the use of certain hazardous substances in electrical and electronic equipment.



Measures for the Administration of the Control of Pollution by Electronic Information Products (China)



	T950 有毒和有害物质及元素					
	铅 (Pb)	汞 (Hg)	镉 (Cd)	六价铬 (Cr(VI))	多溴联苯 (PBB)	多溴联苯醚 (PBDE)
磁带库	X ¹	O	X ²	O	O	O
磁带驱动器 IBM LTO-3	X ^{1,4}	O	O	O	O	O
磁带驱动器 IBM LTO-4	X ^{1,8}	O	O	O	O	O
磁带驱动器 IBM LTO-5	X ¹	O	O	O	O	O
摄像机 Camera	X	O	O	O	O	O

1. 电路板焊料含有铅。服务器，存储器和存储阵列系统，用于转接、信号和传输的网络基础设施设备，以及电信网络管理设备的焊料都含有铅。
2. 电气触点和镉镀层，不包括 76/769/ECC 指令的修订指令 91/338/EE 所禁止的应用，此等指令对某些危险物质的营销和使用列有若干限制条款。
3. 柔性电缆含有十溴联苯醚 (Deca-PBDE)。若干聚合物应用的 Deca-PBDE 用量超过最大浓度限定值 (MCV)。
4. 铅含量可能高达 3.2 克。
5. 钢材中的铅含量为 0.35%，铝合金中为 0.4%，青铜等铜合金中为 4.0%。
6. 电子陶瓷零件（例如压电式装置）可能含有铅。
7. 电子部件可能含有铅玻璃。
8. 铅含量可能高达 5.0 克。

Recycling Your Library

For information on recycling your Spectra library, check the Spectra Logic website at: spectralogic.com/environment.

CONFLICT MINERALS POLICY

Spectra Logic is committed to complying with the OECD Due Diligence Guidance for Responsible Supply Chains of Minerals from Conflict-Affected and High-Risk Areas, as well as the applicable requirements of Section 1502 of the Dodd-Frank Act, which aims to prevent the use of minerals that directly or indirectly finance or benefit armed groups in the Democratic Republic of the Congo (DRC) or in adjoining countries (“conflict minerals”).

Affected suppliers to Spectra Logic will be required to commit to being or becoming “conflict-free” (which means that such supplier does not source conflict minerals) and sourcing, where possible, only from conflict-free smelters. Each affected supplier to Spectra Logic will be required to provide completed EICC-GeSI declarations evidencing such supplier's commitment to becoming conflict-free and documenting countries of origin for the tin, tantalum, tungsten, and gold that it purchases.

For more information on Spectra Logic's conflict minerals program contact conflictminerals@spectralogic.com.

INDEX

A

- AC power
 - breakers, main or drive frame 36
 - connecting to library 141
 - cord and connector types 479
 - cord locks,
 - installing 409 to 410
 - main breaker switches 141
 - specifications 479
- activation key
 - entering 97 to 98
 - entering BlueScale Software Support key 97 to 98
 - obtaining for BlueScale options 98 to 99
 - renewing BlueScale Software Support key 386
- adding a new user 91
- address, Ethernet IP address
 - library (LCM) 103, 104 to 106
- address, Fibre Channel ports
 - direct-attached drives 183
 - exporting controller 185 to ??
 - F-QIP, SCSI drive partition 185 to ??
 - RIM ?? to 186
- address, SMTP 108
- Administrator group
 - default user name and password 91
 - privileges 91
- advanced import/export
 - create move queue 216 to 219
 - processing move queue 222 to ??
 - requirements for using 216
- agency declarations
 - EU Declaration of Conformity 497 to 501
 - FCC notice 498
 - RoHS 500
 - RoHS, China 502
 - safety 498
 - WEEE 500
- alarms, configuring in AutoSupport 305 to 306
- architecture
 - cleaning partitions and Auto Drive Clean 53 to 54
 - controller failover 66 to 68
 - entry/exit pool 49
 - Fibre Channel
 - connectivity 58 to 65
 - Fibre Channel drive failover 68
 - free pool 49
 - redundant network
 - connectivity 66 to 68
 - storage partitions 52
 - storage pool 50
- asterisk (*)
 - in MLM record 286
 - in MLM reports 454
 - in password field 92
- attention required notification
 - drive health 292
 - media health 277
 - system 78
- Auto Drive Clean
 - affect of a failed cleaning 161
 - configuring a cleaning partition 166 to 169
 - description 53 to 54
 - frequency 161
 - requirements for using 53, 161, 162, 204
 - restrictions when running PreScan 265
 - using to manually clean a drive 416
- auto saved configuration file
 - description 109, 136
 - enable email 108 to 109
 - filename 136
 - using to restore
 - library 341 to 346
- automatic media discovery, *See* MLM, Media Auto Discovery
- AutoSend profile
 - autosupport@spectralogic.com 303
 - configuring 303
- AutoSupport log (ASL)
 - description 298
 - sending automatically 307
 - sending manually 308 to 312
 - See also* log set forwarding
- AutoSupport, configuring
 - AutoSend profile 303
 - create or modify
 - profiles 301 to 305
 - critical alarm
 - notification 305 to 306
 - deleting profiles 305
 - log set forwarding
 - recipient 307
 - mail recipients 300
 - requirements 300
- AutoSupport, using
 - creating a new HHM ticket 324 to 328
 - creating a new support ticket 308 to 312
 - overview 297 to 299
 - updating a ticket 312 to 313
- average status, media health 276

B

- background operations, restrictions
 - during MLM operations 251
 - import, export, or exchange media 201
- backup
 - library configuration,
 - automatic 136
 - library configuration,
 - manual 135 to 139
 - MLM and DLM
 - databases 282 to 284

- backup software
 - cleaning cartridge accessibility
 - in cleaning partition 204
 - compatibility 484
 - drive cleaning without Auto Drive Clean 198
 - importing cartridges into new partition 202
 - PostScan blackout periods
 - during backup window 270
 - time-out requirements 270
 - backups, continuing while
 - cleaning drives 414
 - resetting the RCM or LCM 334
 - updating drive firmware 426, 432, 434, 438
 - barcode labels
 - asterisk (*) in MLM record 286
 - asterisk (*) in MLM reports 454
 - checksum character 127
 - CLN prefix for cleaning cartridges 198
 - configuring reporting 124
 - custom sequences 467
 - determining type 127 to 128
 - placement on cartridges 199
 - requirements for cleaning partition 204
 - role in maintaining the library inventory 224
 - specifications 492 to 496
 - "x" in Inventory screen 227
 - barcode reader description 31
 - best practices
 - cartridge use 459 to 465
 - drive cleaning 462
 - entry/exit pool 462
 - handling cartridges 460
 - MLM 451 to 454
 - protecting library's saved data 455 to 458
 - blackout period for
 - PostScan 258 to 259
 - BlueScale Drive Lifecycle Management
 - description 25
 - See also* DLM
 - BlueScale Energy Audit
 - description 25
 - See also* power consumption
 - BlueScale Hardware Health Monitoring
 - description 26
 - See also* HHM
 - BlueScale Media Lifecycle Management
 - description 26
 - See also* MLM
 - BlueScale software
 - overview 23 to 27
 - See also* software, BlueScale
 - See also* user interface
 - BlueScale Software Support key
 - enabling 97 to 98
 - expired key 386
 - overview 95 to 99
 - renewing 386 to 387, 468
 - required for firmware updates 95
 - See also* software, BlueScale
 - BlueScale user interface
 - access options 71 to 73
 - features 73 to 80
 - See also* touch screen interface
 - See also* user interface
 - See also* web interface
 - touch screen interface
 - See also* user interface
 - BlueScale web interface, *See* web interface
 - born on date for MLM-enabled media, definition 275
 - breakers, AC power
 - description, main or drive frame 36
 - location 32
 - power on library 141
 - broadcast capacity
 - configuring 257 to 258
 - description 257
 - bulk load 233
 - buttons
 - do not use keyboard Enter key 87
 - in status bar 78
 - library power 142
 - refresh display 78
 - reset, LCM or RCM 334
-
- ## C
- cables
 - AC connector types 479
 - Ethernet, requirements 485
 - Fibre Channel, requirements 485
 - capacity
 - adding 96, 470
 - hardware ID to purchase additional 98
 - in broadcast view 257
 - library specifications 474
 - on-demand, description 47, 96, 470
 - TeraPack magazines 198
 - upgrades 96, 470
 - Capacity-on-Demand (CoD)
 - See* capacity
 - See* upgrades
 - CarbideClean, description 466
 - carrying cases for magazines 468
 - cartridges, exporting or exchanging
 - exchange from storage or cleaning partition 212 to ??
 - export from storage or cleaning partition 211 to ??
 - overview 201 to 202, 209 to 210
 - preparation 210
 - requirements 201
 - restricted during background operations 201
 - cartridges, general information
 - barcode labels, purchasing 467
 - Certified Media, description 466
 - purchasing 467
 - Spectra Certified Media, MLM-enabled 244
 - TeraPack magazines 46
 - cartridges, importing
 - into storage or cleaning partition 202 to ??
 - overview 201 to 202

- requirements 201, 202 to 204
- restricted during background operations 201
- cartridges, inventory
 - during FullScan 267
 - during QuickScan using Global Spare 268
 - overview 224
 - update backup software inventory 222
 - See also* inventory 224
- cartridges, moving
 - create a move queue file 237 to 239
 - create move queue manually 232 to 235
 - process manual move queue 236
- cartridges, moving within library
 - See* move queue, cartridges
 - See* move queue, magazines
- cartridges, preparing
 - guidelines and requirements 197 to 199
 - label placement caution 199
 - labeling guidelines 459
 - loading into magazines 200
 - set write-protect switch 199
- cartridges, troubleshooting
 - MLM Load Count report 275
 - MLM Media Health report 275
 - MLM Write Errors report 275
 - overriding red MLM health 280 to 281
- cartridges, using
 - barcode label requirements 198 to 199
 - best practices 459 to 465
 - data cartridge capacities 491
 - environmental specifications, tape 490
 - locating in library 231
 - media pool locations 49 to 50
 - media type for cleaning partition 168
 - media type for storage partition 172
 - rotation example 463 to 465
 - storage guidelines 461
 - See also* cleaning cartridges
- See also* magazines
- cartridges, using with MLM
 - adding to MLM database 247, 260 to 261
 - asterisk (*) in MLM record 286
 - asterisk (*) in MLM report 454
 - available reports 275
 - best practices 451 to 454
 - capacity shown in Filled Capacity bar graph 252
 - enable MLM 255
 - enabling automatic discovery 256
 - generating MLM reports 273 to 278
 - health score 276
 - health status icons 276
 - MAM, description 244
 - manually add to PostScan queue 270 to 272
 - MLM alerts 255
 - Remaining Capacity report 248
 - requirements 244
 - requirements for updating MAM 265, 269
 - saving MLM reports 278 to 280
 - start manual MLM discovery 262 to 263
 - stop MLM discovery process 264
 - track health and usage 248
 - usage information in DLM report 294
 - See also* MLM
- cautions
 - deleting partitions 194
 - do not rewind cleaning cartridges 414
 - hardware reconfiguration 385
 - label cleaning cartridges 415
 - labeling cartridges 199
 - packaging components for shipping 450
 - reset after firmware update 406
- resetting library components 333
- use approve cleaning cartridges 414
- center TAP, using
 - exporting magazines 212
- Certified Media
 - description 466
 - for use with MLM 244
 - MLM alert 255
 - purchasing 468
 - See also* cartridges
- chambers
 - assigning to cleaning partition 168
 - assigning to storage partition 176 to 177
 - description 31
 - editing partitions 191
 - marked as unusable 322
 - modify number in a partition 191
- changing users 86
- checksum character, definition 127
- cleaning cartridges, general information
 - LTO drives 492
 - Maintenance TeraPack magazines 467
 - purchasing 467
- cleaning cartridges, using
 - automatic drive cleaning 415
 - availability in cleaning partition 162
 - barcode label requirements 204
 - cleaning partition present 416
 - CLN barcode prefix 198
 - do not rewind 414
 - exchange 212 to ??
 - expired 54, 227
 - export from cleaning partition 211 to ??
 - export or exchange expired 213 to 215
 - import into cleaning partition 202 to ??
 - label when stored in library 415

- no cleaning partition
 - present [417 to 418](#)
- software-based drive
 - cleaning [204](#)
 - tracking use [418](#)
 - See also* cartridges
- cleaning cartridges, using with MLM
 - available reports [275](#)
 - health score [276](#)
 - track number of cleans remaining [249](#)
 - "x" next to slot number [227](#)
 - See also* MLM
- cleaning drives
 - automatic [415](#)
 - manual, no cleaning partition [417 to 418](#)
 - manual, using cleaning partition [416](#)
 - overview [412](#)
 - See also* drives, cleaning
- cleaning notification on Drive Details screen [413](#)
- cleaning partitions, configuring
 - assign chambers [168](#)
 - for automatic drive cleaning [166 to 169](#)
 - initial settings [167 to 168](#)
 - name and media type [168](#)
 - requirements [161](#)
 - slot requirements [161](#)
- cleaning partitions, using
 - cleaning Global Spare drives [162](#)
 - exchange maintenance magazines [212 to ??](#)
 - export maintenance magazines [211 to ??](#)
 - export or exchange expired cartridges [213 to 215](#)
 - import maintenance magazines [202 to ??](#)
 - import requirements [204](#)
 - maintenance magazine requirement [198](#)
 - manual drive cleaning [416](#)
 - overview [53 to 54](#)
 - prepare for imports [205](#)
 - See also* export or exchange media
- See also* import media
- Cleans Remaining, MLM report [275](#)
- CoD, *See* capacity
- command processing, progress bar [80](#)
- compatibility
 - host interface [485](#)
 - host software [484](#)
 - host software, using emulation [122](#)
 - LTO read/write [491](#)
- compliance
 - FCC notice [498](#)
 - hazardous materials directives [500 to 501](#)
 - regulatory agency [497 to 501](#)
 - safety agency [498](#)
- component identifiers
 - controllers [57](#)
 - drives [57 to 58](#)
- components
 - front panel [28](#)
 - interior [30 to 31](#)
 - rear panel, drive frame [32 to ??](#)
- computer module, *See* LCM and *See* RCM
- configuration
 - users [90](#)
- configuration backup file
 - auto saved, using to restore library [341 to 346](#)
 - creating [136 to 138](#)
 - manual, using to restore library [346 to 348](#)
- Configuration toolbar, options [75](#)
- configuration, AutoSupport
 - configuring alarms [305 to 306](#)
 - create or modify profiles [301 to 305](#)
 - deleting profiles [305](#)
 - log set forwarding [307](#)
 - mail recipients [300](#)
 - requirements [300](#)
- configuration, DLM, enable or disable [255](#)
- configuration, encryption
 - assign a BlueScale key to partition [181](#)
- assign Spectra SKLM server to partition [181](#)
- See also* encryption
- configuration, library
 - accessing the System Setup screen [93](#)
 - back up, manual [136 to 139](#)
 - backing up, automatic [136](#)
 - controller failover [119 to 121](#)
 - date and time [110](#)
 - display refresh rate [100](#)
 - emulation [122 to 123](#)
 - enable and configure SNMP [102](#)
 - enable email for auto saved configuration file [108 to 109](#)
 - enable or disable metrics monitoring [101](#)
 - enable or disable Soft Power [102](#)
 - enable SSL [102](#)
 - IP address [104 to 106](#)
 - library name, as identifier for remote access [100](#)
 - list of enabled options [97](#)
 - mail recipients [106 to 108](#)
 - package servers [129 to 131](#)
 - renewing BlueScale Software Support key [386 to 387](#)
 - restore using auto-save backup file [341 to 346](#)
 - restore using manual backup file [346 to 348](#)
 - Rotation Manager [133 to 135](#)
 - routine maintenance option [115](#)
 - SNMP [116 to 118](#)
 - Syslog server IP address [103](#)
 - user-based security [81, 90](#)
 - verifying backup file [139](#)
 - web server port [100](#)
- configuration, MLM
 - alerts [255](#)
 - broadcast capacity [257](#)
 - configure PostScan blackout periods [258 to 259](#)
 - enable or disable MLM [255](#)
 - Media Auto Discovery [256](#)
 - non-certified media [255](#)
 - See also* MLM

- configuration, partitions
 - confirm and save
 - settings 187 to 189
 - creating cleaning
 - partitions 166 to 169
 - creating storage
 - partitions 169 to 186
 - emulation mode 122 to 123
 - encryption mode 181
 - entry/exit pool 176 to 177
 - exporting controller port
 - addressing 185 to ??
 - F-QIP port
 - addressing 185 to ??
 - modifying 190
 - overview 160 to ??
 - RIM port
 - addressing ?? to 186
 - robotic control path
 - visibility 184
 - storage pool 176 to 177
 - user access 184
 - configuration, system settings
 - changing 99 to 111
 - defaults 100 to 103
 - conflict minerals policy 502
 - connectivity
 - Fibre Channel drives ?? to 65
 - redundancy 66 to 68
 - robotics, through
 - controller 59 to 64
 - See also* controller failover
 - connectors
 - AC power, main or drive
 - frame 36
 - Ethernet, LCM 40
 - international power 480
 - network cables 485
 - specifications, AC power 479
 - USB port 39
 - contacting Spectra Logic 7
 - controller
 - component identifiers 57
 - descriptions 42 to ??
 - functional
 - description 59 to 64
 - controller failover
 - configuring 119 to 121
 - description 66 to 68
 - disabling 121
 - controller
 - See also* F-QIP
 - See also* RIM
 - cooling requirements 481
 - cord locks, installing 409 to 410
 - corporate headquarters, Spectra Logic 7
 - cover, TeraPack magazine 461
 - creating move queue
 - file 237 to 239
 - Critical Alarms
 - AutoSend profile 303
 - configuring in
 - AutoSupport 305 to 306
 - description 298 to 299
 - custom barcode labels,
 - purchasing 467
-
- D**
- data
 - library capacity 474
 - data cartridges, *See* cartridges
 - storage partitions, moving
 - cartridges
 - See* move queue, magazines
 - databases, MLM and DLM
 - See* DLM database
 - See* MLM database
 - date
 - in status bar 78
 - setting 110
 - DBA
 - description 33
 - location 32
 - power supply modules,
 - description 35
 - purchasing 471
 - DCM firmware
 - current version 153
 - default settings
 - system
 - configuration 100 to 103
 - user names and passwords 91
 - default users
 - passwords 90
 - privileges 90
 - deleting
 - individual MLM records 285
 - library users 93
 - multiple MLM records 286
 - partitions 194
 - device drivers, updating for LTO
 - drives 441
 - DHCP, using
 - library (LCM) IP
 - address 104 to 106
 - diagnostics
 - accessing 76
 - accessing the Run All Motion
 - Basic Tests 74
 - overview 24
 - running the Run All Motion
 - Basic Tests 337 to 339
 - DLM database
 - backing up 282 to 284
 - download as XML
 - file 295 to 296
 - information stored 293
 - restore from backup on USB
 - device 348
 - restore using auto-save backup
 - file 341 to 346
 - DLM, enable or disable 255, 288
 - DLM, overview
 - description 25
 - how it works 288
 - DLM, using
 - drive health status 294
 - generating reports 293 to 295
 - health status icons 291 to 292
 - requirements for drive
 - test 379
 - saving report 295
 - testing a drive 379 to 383
 - viewing tape usage 294
 - documentation
 - related to drive use 20
 - related to library use 19
 - typographical conventions 21
 - updated information in release
 - notes 388

- Drive Bay Assembly, *See* DBA
 - drive cleaning notification on Drive Details screen 414
 - drive component
 - identifier 57 to 58
 - Drive Control Module, *See* DCM
 - drive expansion frame,
 - description 54
 - Drive Firmware Update wizard
 - using 434 to 437
 - Drive Lifecycle Management, *See* DLM
 - Drive Performance Monitor
 - enable/disable 101
 - using 149 to 150
 - drive sled
 - description and connector locations 45
 - drive component identifier 57
See also DCM
 - drive trace files
 - retrieving 357 to 362
 - saving 359
 - Drives screen, accessing 74
 - drives, cleaning
 - automatic cleaning 53 to 54, 415
 - configure Auto Drive Clean 166 to 169
 - determine cleaning method 415
 - determine if cleaning is required 413 to 414
 - manual, no cleaning partition 417 to 418
 - manual, using cleaning partition 416
 - prepare library 414
 - required materials 414
 - drives, configuring
 - as Global Spare 173 to 175
 - assigning to partitions 177
 - drive-based encryption 181
 - element addresses after installing additional 322, 385
 - Fibre Channel loop IDs 183
 - replacing 443
 - drives, firmware
 - check for update 422 to 423
 - current version 153, 420
 - device drivers 184, 420, 441
 - discontinue backups & empty drives before update 426, 432, 434, 438
 - requirements for firmware update using Package Update, LTO-5 and later generation drives 427
 - requirements for using firmware update tape 434, 437
 - update using firmware tape with update utility 437 to 440
 - update using firmware tape wizard 434 to 437
 - update using ITDT 426
 - drives, general information
 - component identifiers 57 to 58
 - descriptions 44 to 46
 - Fibre Channel connectivity ?? to 65
 - Fibre Channel port location 44
 - purchasing 471
 - related documentation 20
 - supported types 44
 - drives, monitoring with DLM
 - generating reports 293 to 295
 - saving a report 295
 - drives, specifications
 - heat dissipation 481
 - LTO 486 to ??
 - power consumption and heat dissipation 481
 - read/write compatibility, LTO generations 491
 - TS11xx technology 489
 - drives, troubleshooting
 - activating Global Spare 352 to 355
 - DLM tape usage 294
 - host cannot access drive 364
 - host cannot read/write data 363
 - identify problem 362 to 364
 - LTO WORM media errors 367
 - LTO, status LED 366
 - power-cycling 351
 - resetting 351
 - retrieving trace files 357 to 362
 - returning Global Spare to spare pool 356
 - sense code lookup 315, 362
 - serial number 153
 - test using DLM 379 to 383
 - drives, using
 - activating Global Spare drive 352 to 355
 - DLM health status icons 291 to 292
 - DLM monitoring 289 to 295
 - Fibre Channel WWN 65, 155
 - Global Spare icons 355
 - installing new 442
 - returning Global Spare to spare pool 356
 - viewing performance metrics 149 to 150
 - viewing status 153
 - dual AC power module
 - location 32
-
- ## E
- EE chambers, *See* entry/exit pool
 - EE pool, *See* entry/exit pool
 - EE port, *See* TAP
 - email
 - configuring recipients 106 to 108
 - drive trace results 359
 - enabling for auto saved configuration file 108 to 109
 - Spectra Logic offices 7
 - trace results 331
 - See also* mail recipients
 - emulation
 - configuring 122 to 123
 - description 122
 - enabling options
 - enter activation key 97 to 98
 - overview 95 to 99

- encryption
 - using direct-attached drives 181
 - using partitions to manage 52
- encryption key, BlueScale
 - assigning to a partition 181
 - stored in auto save configuration file 135
- encryption, overview
 - drive-based features 490
- EnergyAudit
 - description 25
 - See also* power consumption
- entering information
 - using external keyboard 88
 - using soft keyboard 87
 - using the web interface 87
- entry/exit pool
 - best practices 462
 - configuring 176 to 177
 - description 49
 - exchange magazines 212 to ??
 - export magazines 211 to ??
 - import magazines 202 to ??
 - loading empty magazines 209
 - minimum number of chambers 177
 - minimum requirement 49
 - preparing for use 209
 - space requirements for imports and exports 203
 - view inventory 224 to 227
- entry/exit port
 - See* entry/exit pool
 - See* TAP
- environmental specifications
 - library, operating 483
 - library, shipping and storing 483
 - tape media 490
- error codes
 - for drive troubleshooting 315, 362
 - LTO-3 through LTO-6 drives 366 to 374
 - TS11xx technology drives 374 to 378
- error condition
 - HHM threshold, status notification 324
 - media health 277
 - system, status notification 78
- EtherLib 25
- Ethernet connector
 - description 40
 - using on RCM 40
- Ethernet network
 - configuring library web server port settings 100
 - library (LCM) IP address 104 to 106
- EU Declaration of Conformity 497 to 501
- events, configuring
 - alarms 305 to 306
- expansion frames
 - description 54
 - purchasing 471
- export or exchange
 - using advanced import/export options 216 to ??
- export or exchange media
 - overview 201 to 202, 209 to 210
 - remote access restrictions 201
 - requirements and restrictions 201 to 202
 - See also* cartridges, exporting or exchanging
 - See also* cleaning cartridges, using
 - See also* magazines, exporting or exchanging
- Exported Media report, MLM 275
- exporting controller
 - definition 59
 - port addressing for partition 185 to ??
 - See also* controller
 - See also* F-QIP
 - See also* RIM
- exporting controller (RIM) ?? to 186
- Fibre Channel drives 183
- failover
 - configuring for exporting controller 119 to 121
 - configuring for Fibre Channel drives 68
 - controller failover process 66 to 68
 - power supplies, main and drive frames 69
 - See also* controller failover
- fax numbers, Spectra Logic 7
- features
 - BlueScale user interface overview 23 to 27
 - hardware components 27 to ??
 - user interface 73 to 80
- Fibre Channel
 - cable requirements 485
 - connectivity 58 to 65
 - protocol support 485
- Fibre Channel drives
 - connection requirements 45
 - drive sled connectors 45
 - loop IDs 183
 - sled connector locations, TS11xx technology 44
 - WWN 65, 155
- Fibre Channel partitions, WWN 62, 156
- Fibre Channel port locations
 - drive sleds 44
- filenames
 - auto saved configuration file 455
 - downloaded DLM database 296
 - library configuration backup 456
 - MLM and DLM database backup 456
 - MLM report 278
 - move queue file 239
 - traces 332
- firmware tape
 - using Upgrade Drive Firmware utility 437 to 440

F

- fabric address settings
 - exporting controller (RIM or F-QIP) 185 to ??

using with Drive Firmware
Update wizard 434 to 437

firmware, drives

- check for update 422 to 423
- current version 420
- discontinue backups & empty drives 426, 432, 434, 438
- firmware update tape, requirements for use 434, 437
- firmware update using Package Update, LTO-5 and later generation drives, requirements for use 427
- prepare for update 419 to 423
- update using ITDT 426
- update using update wizard 434 to 437
- update using upgrade utility 437 to 440

firmware, library

- for individual components 390
- See also* BlueScale Software Support key
- See also* software, BlueScale

flash codes

- LTO-3 through LTO-6 366 to 374
- permanent errors on LTO-2 through LTO-6 367

F-QIP

- component identifier 57
- connectivity for robotics 59 to 64
- controller failover operation 66 to 68
- fabric mode in partition configuration 186
- Fibre Channel port usage 63 to 64
- hardware reset 335
- location 32
- port visibility, robotics 184
- reset button 335
- reset using Reset Controller utility 335 to 336
- See also* RIM

F-QIP, partition configuration

- port addressing 185 to ??

frames

- description 54
- maximum number 55, 476
- numbering in component identifiers 56

free pool

- contains magazines after configuration restore 344
- description 49

front panel components 28

FullScan

- description 267
- enable/disable 180

G

gateway address

- setting for library 105, 106

General toolbar options 74

Global Spare drive

- activating during PostScan 267
- backup software guidelines 353
- cartridge in drive following reset 323
- cleaning 162
- cleaning during PostScan operations 269
- configuration requirements 174
- configuring 173 to 175
- description 69
- partition requirements 174
- PostScan requirements 174, 175
- returning to spare pool 356
- status icons 355
- use requirements 352
- using 352 to 355

good status

- drive health 292
- media health 276
- system 78

groups

- library users 90
- security 90

groups, library users 81, 90

guidelines

- MLM 451 to 454
- protecting library's saved data 455 to 458
- using cartridges 459 to 465

H

Hardware Health Monitoring, *See* HHM

hardware ID

- locating 98
- required to purchase options 98
- See also* serial number

hardware, reconfiguration

- caution 385

hazardous materials directives, compliance 500 to 501

heat dissipation 481

HHM

- creating an AutoSupport ticket 324 to 328
- description 26
- icon 80
- using to monitor library health 324
- viewing library health data 328 to 329

host software

- compatibility 484
- using emulation for compatibility 122

I

IBM LTO, *See* LTO

icons

- camera 79
- DLM drive health 291 to 292
- Error condition 78
- Global Spare drive 355
- Information 78
- keyboard 85
- Maintenance 80
- MLM media health 276
- network settings 79

- Notice 78
 - refresh display button 78
 - status bar 78
 - Switch User 86
 - system messages 78
 - System OK 78
 - system status 78
 - identifiers
 - controllers (RIM or F-QIP) 57
 - drives 57 to 58
 - import media
 - into cleaning or storage partition 202 to ??
 - overview 201 to 202
 - remote access restrictions 201
 - requirements and restrictions 201 to 202
 - See also* cartridges, importing
 - See also* magazines, importing
 - Import/Export TeraPack
 - Magazines screen
 - use for advanced import/export operations 217
 - using 206
 - using to export magazines 211
 - using to import magazines 207
 - importing magazines
 - using advanced import/export options 216 to ??
 - improper packaging, charges for damage 450
 - initialization, library power-on 141
 - interfaces
 - Ethernet requirements 485
 - Fibre Channel 58 to 65
 - Fibre Channel requirements 485
 - supported for host 485
 - USB 486
 - interoperability, host software 484
 - inventory
 - backup software, updating after an import 222
 - downloading as XML file 227 to 230
 - during FullScan 267
 - during QuickScan using Global Spare 268
 - expired cleaning cartridge 227
 - locating a specific cartridge 231
 - moving cartridges within a partition 231 to 242
 - overview 224
 - requirements for downloading 224
 - viewing 224 to 227
 - IP address
 - displayed on status bar 79
 - library (LCM), configuring 104 to 106
 - Syslog server IP address 103
 - viewing 103
 - ITDT
 - installing 424
 - using to retrieve drive dump files 359
 - using to test drives 367
 - using to update LTO drive firmware 426
 - using to view status LED state 366
-
- K**
 - key
 - entering to activate option 97 to 98
 - renewing for BlueScale Software Support 386 to 387
 - See also* options
 - See also* encryption key
 - keyboard
 - do not use the Enter key 72
 - LCM connector 39
 - supported characters 88
 - touch screen 87
 - using Enter key 88
 - using external 88
 - using the web interface 87
 - Knowledge Base
 - library troubleshooting 315, 362
-
- L**
 - labels
 - placement on cartridges 492
 - labels, barcode
 - best practices 459
 - cleaning cartridges 198
 - label placement caution 199
 - ordering custom barcode sequences 467
 - placement on cartridges 199
 - specifications 492 to 496
 - LC server
 - description 37
 - web server 41
 - See also* operator panel
 - See also* user interface
 - See also* web interface
 - See also* LCM
 - LCM
 - Auto-Save Configuration 23
 - capturing traces 330 to 332
 - configuration data on memory card 40
 - configuring IP address 104 to 106
 - connecting a USB device 158
 - Ethernet connection 40
 - functional description 41
 - location 32, 41
 - resetting 334
 - routine maintenance option 115
 - See also* LC server
 - LEDs
 - LTO status 366
 - power supply module status, drive frame 35
 - power supply status, robotics 34
 - library configuration
 - back up settings 135 to 139
 - list of enabled options 97
 - restore using auto-save backup file 341 to 346
 - restore using manual backup file 346 to 348
 - security, configuring users 90

- library control module
 - description 39 to 41
 - See also* LCM, RCM
- Library Control Module, *See* LCM
- library controller, *See* LC server
- library hardware upgrades 471
- library messages
 - checking 146
 - forwarding to a Syslog server 103
- library serial number, locating 98
- library, BlueScale software, *See* software, BlueScale
- library, components
 - AC power breakers and connectors, main or drive frame 36
 - front panel 28 to ??
 - interior 30 to 31
 - rear panel 32 to ??
- library, configuring
 - activation key
 - overview 95 to 99
 - add, modify, or delete users 90 to 93
 - adding capacity 96, 470
 - auto saved configuration file, description 109
 - back up settings 135 to 139
 - changing system
 - settings 99 to 111
 - controller failover 119 to 121
 - date and time 110
 - default IP address 104
 - default system
 - settings 100 to 103
 - emulation 122 to 123
 - enable and configure SNMP 102
 - enable email for auto saved configuration file 108 to 109
 - enable firmware
 - updates 97 to 98
 - enable Media Auto Discovery 256
 - enable or disable metrics
 - monitoring 101
 - enable or disable Soft Power 102
 - enable SSL 102
- enable/disable performance monitoring 101
- enable/disable power consumption monitor 101
- Global Spare
 - drives 173 to 175
- IP address 104 to 106
- mail recipients 106 to 108
- package server 129 to 131
- Rotation Manager 133 to 135
- routine maintenance
 - option 115
- setting name 100
- setting Syslog server IP address 103
- setting web server port 100
- SNMP 116 to 118
- library, firmware, *See* software, BlueScale
- library, general information
 - documentation updates in release notes 388
 - host software
 - compatibility 484
 - purchasing
 - upgrades 469 to 471
 - related documentation 19
- library, import, export, exchange media
 - exchange magazines 212 to ??
 - export magazines 211 to ??
 - export or exchange expired
 - cleaning
 - cartridges 213 to 215
 - import magazines 202 to ??
 - import magazines, first time 202
 - preparing entry/exit pool 209
- library, installation
 - connect AC power 141
 - installing AC cord
 - locks 409 to 410
 - moving 385
- library, maintaining
 - BlueScale package update procedure 388 to 406
 - prepare to update
 - BlueScale 388 to 394
 - updating RCM using USB device 400
- library, overview
 - BlueScale features 23 to 27
 - hardware features 27 to ??
 - user interface 73 to 80
- library, specifications
 - data capacity 474
 - environmental 483
 - host interfaces supported 485
 - recycling 500
 - shock and vibration
 - limits 484
 - size and weight, installed 477
 - size and weight, shipping 478
- library, troubleshooting
 - BlueScale interface
 - issues 316 to 318
 - calibrate touch screen 410
 - capturing traces 330 to 332
 - cartridge in Global Spare
 - following a reset or power-cycle 323
 - cartridge left in tape drive 323
 - chambers marked as unusable 322
 - configuration restore
 - options 340
 - encryption 320
 - encryption issues 320 to 321
 - encryption moniker 320
 - encryption server 320
 - general 315
 - magazines in free pool after configuration restore 344
 - magazines in TAP after a power failure 322
 - MLM issues 319
 - recovering media after power failure 322
 - resetting a RIM or F-QIP 335 to 336
 - resetting library 333
 - resetting the LCM/RCM 334
 - restore using auto-save backup file 341 to 346
 - restore using manual backup file 346 to 348
 - running the Run All Motion Basic Tests 337 to 339
 - Spectra SKLM
 - requirements 320

- using Knowledge Base 315, 362
 - library, users
 - deleting 93
 - modifying existing 93
 - library, using
 - activating Global Spare drive 352 to 355
 - backing up
 - metadata 455 to 457
 - best practices, saved data 455 to 458
 - BlueScale software version on status bar 389
 - connectivity
 - overview 58 to ??
 - download cartridge inventory as an XML file 227 to 230
 - entering an SSL security certificate 113
 - IP address displayed on status bar 79
 - locating a specific cartridge 231
 - logging in 82 to 86
 - logging in from Library Controller Login screen 85
 - logging in from pre-login General Status screen 84
 - logging in with SSL enabled 84
 - logging out or switching users 86
 - name displayed in email messages 100
 - name displayed on status bar 79
 - power-off procedure 143
 - power-on sequence 141
 - requirements for downloading cartridge inventory 224
 - restrictions while PostScan runs 269
 - returning Global Spare to spare pool 356
 - security, users and groups 81, 90
 - SNMP 116 to 118
 - Soft Power to power off 143 to 144
 - switching or logging out user 86
 - Syslog messaging 148
 - view cartridge inventory 224 to 227
 - view status 74
 - viewing drive status 153
 - viewing metrics 145 to 152
 - viewing robot utilization information 152 to 153
 - viewing status 78, 83
 - WWN for partitions 62, 156
 - license agreement, software 3
 - Load Count report, MLM 275
 - local interface, *See* touch screen interface
 - log set forwarding
 - configuring recipient 307
 - description 298
 - See also* AutoSupport
 - logging into library, security certificate warning 112
 - loop ID
 - exporting F-QIP 185 to ??
 - Fibre Channel drives 183
 - F-QIP-attached SCSI drives 185 to ??
 - RIM ?? to 186
 - RIM or F-QIP 185 to ??
 - LTO
 - cartridge capacities 491
 - cartridge MAM 244
 - cartridges per TeraPack magazine 46
 - drive specifications 486 to ??
 - read/write compatibility 491
 - supported drive generations 44
 - troubleshooting drives 362 to 383
 - WORM media 492
 - See also* drives
-
- ## M
- M8 media 200
 - magazines
 - media pool locations 49 to 50
 - processing import/export move queue 216 to ??
 - purchasing 467
 - See also* Maintenance TeraPack magazine
 - See also* TeraPack magazine
 - magazines, exporting or exchanging
 - during PreScan or PostScan 425, 432, 438
 - during QuickScan using Global Spare 268
 - exchange from storage or cleaning partition 212 to ??
 - export from storage or cleaning partition 211 to ??
 - export requirements 201
 - overview 201 to 202, 209 to 210
 - prepare to export or exchange 210
 - restricted during background operations 201
 - using advanced options 216 to ??
 - magazines, importing
 - cleaning cartridge into storage partition 417 to 418
 - during FullScan 267
 - during PreScan or PostScan 425, 432, 438
 - during QuickScan using Global Spare 268
 - maintenance magazines for cleaning partitions 198
 - overview 201 to 202
 - requirements 201, 202 to 204
 - requirements for importing into entry/exit pool 203
 - requirements for importing into storage pool 203
 - restricted during background operations 201
 - storage or cleaning partition 202 to ??
 - using advanced options 216 to ??

- magazines, moving within library,
 - See* move queue, cartridges
- magazines, using
 - barcode label requirements 198
 - carrying cases 468
 - inserting cartridges 200
 - inserting into TAP 208
- mail recipients
 - AutoSupport 300
 - configuring 106 to 108
 - See also* email
- mailing address, Spectra Logic 7
- main frame, description 54
- Maintenance TeraPack magazine
 - See also* TeraPack magazine
- maintenance magazines
 - barcode label requirements 198, 204
 - create import/export move queue 216 to 219
 - exchange from cleaning partition 212 to ??
 - export from cleaning partition 211 to ??
 - export or exchange expired cartridges 213 to 215
 - for cleaning partitions 198
 - import into cleaning partition 202 to ??
 - processing import/export move queue 222 to ??
 - using advanced import/export options 216 to ??
 - See also* magazines
 - See also* Maintenance TeraPack magazine
- Maintenance TeraPack magazine
 - identifying 198
- Maintenance toolbar, options 76
- maintenance, drives
 - cleaning 412 to 418
 - device driver 441
 - prepare to update firmware 419 to 423
 - update firmware using ITDT 426
 - update firmware using update wizard 434 to 437
 - update firmware using upgrade utility 437 to 440
 - See also* drives, cleaning
- maintenance, library
 - BlueScale package update procedure 388 to 406
 - prepare to update BlueScale 388 to 394
 - updating RCM using USB device 400
- MAM, description 244
- MCD codes
 - TS11xx technology drives 374 to 378
- Media Auto Discovery, *See* MLM, Media Auto Discovery
- media expansion frame, description 54
- media, M8 200
- media, *See* cartridges
- Medium Auxiliary Memory, *See* MAM
- memory card
 - configuration data stored 40
 - location in LCM or RCM 39
- message types, definitions 108
- messages
 - date and time stamp 110
 - HHM notification 324
 - icons, MLM media health 276
 - icons, system status 78
 - library name 100
 - LTO cleaning notification 365
 - types 78
- metadata
 - backing up 455 to 457
 - best practices 455 to 458
 - definition 455
 - See also* DLM database
 - See also* encryption keys
 - See also* library configuration
 - See also* MLM database
- metrics
 - drive performance 149 to 150
 - power consumption 151
 - storage density 151
- MLM database
 - adding cartridges 247, 260 to 261
 - backed up in auto saved configuration 136
 - backing up 282 to 284
 - deleting individual records 285
 - deleting multiple records 286
 - description 247
 - download as a CSV file 287
 - maximum number of records 248
 - restore from backup on USB device 348
 - restore using auto-save backup file 341 to 346
 - tracking non-MLM-enabled cartridges 252
- MLM records, asterisk (*) next to barcode label 286
- MLM reports
 - asterisk (*) next to barcode label 454
 - Born on Date 275
 - Cleans Remaining 275
 - Exported Media 275
 - Last Write/Read Time 275
 - Load Count 275
 - Media Health 275
 - Remaining Capacity 275
 - Remaining Capacity, for MLM-enabled cartridges 248
 - saving 278 to 280
 - Write Errors 275
- MLM, configuring
 - broadcast capacity 257
 - enable or disable 255
 - enable PostScan for a partition 270
 - global settings 253 to 256
 - PostScan blackout periods 258 to 259
 - PreScan and PostScan 178 to 180
 - PreScan, enabling 264
- MLM, Media Auto Discovery
 - configuring 256
 - description 245
 - overview 245
 - restricted operations while running 251
 - running during import, export, or exchange operations 202
 - start manual discovery 262 to 263

stop discovery process 264
 using to add cartridges to MLM database 260 to 261

MLM, PreScan and PostScan
 manually add a tape to PostScan queue 270 to 272
 pause PostScan operation 272

PostScan, functional description 265 to 269

PreScan, functional description 264

restricted operations while running 201

MLM, using
 adding cartridges to the database 260 to 261
 best practices 451 to 454
 generating reports 273 to 278
 media alert, description 252
 operational overview 244 to 252
 options for saved reports 279
 overriding red cartridge health 280 to 281
 preparing to implement 260 to 261
 Spectra Certified media 244
 track cleans remaining on cleaning cartridges 249
 track data cartridge health and usage 248
 tracking non-MLM-enabled cartridges 252
 troubleshooting issues 319

monitor, LCM connector 39

mouse, LCM connector 39

move queue, cartridges
 create manually 232 to 235
 create move queue file 237 to 239
 move queue file example 239
 move queue file naming requirement 239
 move queue file syntax 238
 processing move queue file 240 to 242
 requirements for uploading 224
 start processing manually 236

supported moves using move queue file 237

move queue, magazines
 create import/export move queue 216 to 219
 processing moves 222 to ??

N

names
 as identifier used in library messages 100
 cleaning partitions 168
 library identifier for remote access 100
 library, displayed on status bar 79
 library, used in email messages 100

NDMP support 486

network
 interface cable requirements 485
 IP address, library (LCM) 104 to 106

network settings, configuring for library 104 to 106

Network Time Protocol (NTP), configuring servers 110

O

On/Off, main or drive frame AC breakers 36

operating environment
 library 483
 tape media 490

Operator group, default user name and password 91

operator panel
 connecting a USB device 158
 description 37
See also touch screen
See also user interface
See also web interface

options
 activation key overview 95 to 99
 capacity upgrades 96, 470

enabling with activation code 97 to 98
 obtaining activation key 98 to 99
 requirements when purchasing 98, 472
 viewing currently enabled 97

P

package server,
 configuring 129 to 131

package, *See* firmware, library

packaging, improper when shipping 450

partitions
See also cleaning partitions 224
See also storage partitions

partitions, configuring
 assign a BlueScale encryption key 181
 assign a Spectra SKLM server 181
 assign drives 177
 confirm and save settings 187 to 189
 create automatically 167, 171
 delete existing 194
 enable BlueScale encryption 181
 enable Spectra SKLM encryption key management 181
 fabric mode 186
 minimum number of chambers for entry/exit pool 177

MLM PreScan and PostScan 178 to 180
 modify an existing 190
 modify number of chambers 191

PostScan requirements for Global Spares 174, 175

precautions before deleting 194
 prepare to delete a partition 194
 prepare to modify a partition 191

- requirements
 - overview 160 to ??
- robotic control path 172
- run PreScan or PostScan while
 - creating, modifying, or deleting 160
- storage, new 169 to 186
- user access 184
- partitions, general information
 - advantages 52
 - cleaning, overview 53 to 54
 - conceptual overview 50
 - example of use 51
 - storage partition overview 52
- partitions, moving cartridges
 - See* move queue, cartridges
 - See* move queue, magazines
- partitions, using
 - Auto Drive Clean restrictions with PreScan 265
 - download cartridge inventory as an XML file 227 to 230
 - exchange magazines 212 to ??
 - export magazines 211 to ??
 - import magazines 202 to ??
 - import magazines, first time 202
 - inventory overview 224
 - move cartridges using manual move queue 236
 - PostScan requirements for Global Spares 352
 - prepare entry/exit pool 209
 - processing move queue file 240 to 242
 - requirements for downloading cartridge inventory 224
 - view cartridge inventory 224 to 227
 - view WWN 156
 - WWN format 62
- passwords
 - default 85
 - enter or change 92
- PCM, description 35
- permanent errors, LTO-2 through LTO-6 drives 367
- phone numbers, Spectra Logic offices 7
- policies, RMA 450
- pools
 - description 49
 - See also* entry/exit pool
 - See also* free pool
 - See also* storage pool
- poor status
 - drive health 292
 - media health 277
- portal
 - accessing for technical support 444 to 446
 - creating an account 445
 - See also* technical support
- PostScan
 - automatic triggers 266
 - configure blackout periods 258 to 259
 - configure for partition, LTO-4 or LTO-5 178 to 180
 - create or modify partitions while running 160
 - enabling for partition 270
 - export or exchange magazines during 202, 425, 432, 438
 - FullScan option, description 267
 - functional
 - description 265 to 269
 - Global Spare configuration requirements 174, 175
 - Global Spare drive cleaning 269
 - Global Spare use requirements 352
 - interaction with moves 250
 - library operation restrictions 269
 - manually add cartridge to queue 270 to 272
 - operations not permitted while running 272
 - overview 250, 265 to 269
 - pausing operation 272
 - prerequisites for starting 266
 - queue processing 266, 267
- QuickScan time limit, Global Spare drive 268
- QuickScan time limit, partition drive 268
- restricted operations while running 251
- running during import, export, or exchange operations 201
- system messages 250
- triggers, setting 180
- updating drive firmware during 425, 432, 438
- using blackout periods during backup window 270
- power
 - AC inputs 141
 - cord and connector types 479
 - cord locks, installing 409 to 410
 - enabling or disabling Soft Power 102
 - input specifications 479
 - main breaker switches 141
 - requirements 479 to 480
 - Soft Power
 - confirmation 143 to 144
 - Soft Power, description 143
 - turn library on/off 143
 - turn off library using Soft Power control 143 to 144
- power button
 - description 37
- power consumption
 - enable/disable monitoring 101
- library 481
- LTO-6 drives 488
- LTO-7 drives 488
- LTO-8 drives 487
- TS1150 technology drives 489
- TS1155 technology drives 489
- viewing metrics 151
- power control module, *See* PCM
- Power Drive On/Off utility, use with caution 351
- power supply bay, main or drive frame 32
- power supply module
 - DBA, description 35
 - purchasing 471

- robotics, description 34
 - robotics, location 32
 - status LEDs 34, 35
 - power, AC breaker switches, main or drive frame 36
 - PreScan
 - Auto Drive Clean restrictions 265
 - configure for partition, LTO-4 or LTO-5 drives 178 to 180
 - create or modify partitions while running 160
 - enable 180
 - enabling 264
 - export or exchange magazines during 202, 425, 432, 438
 - functional description 264
 - interaction with moves 250
 - overview 250
 - restricted operations while running 251
 - running during import, export, or exchange operations 201
 - start an manual scan 262
 - system message 250
 - updating drive firmware during 425, 432, 438
 - privileges, security 90
 - privileges, user groups 81, 90
 - profiles in AutoSupport
 - create or modify 301 to 305
 - deleting 305
 - progress bar 80
 - protocol support
 - Fibre Channel 485
 - purchasing
 - cleaning cartridges 467
 - custom barcode labels 467
 - drives 471
 - library upgrades 469 to 471
 - purchasing Spectra Certified Media and magazines 468
-
- Q**
- QIP, *See* F-QIP and *See* discontinued components, using
 - QuickScan
 - enabling 180
 - time limit, Global Spare drive 268
 - time limit, partition drive 268
 - using a Global Spare drive, description 268
-
- R**
- RCM
 - configuration data on memory card 40
 - functional description 41
 - location 32, 41
 - resetting 334
 - updating using USB device 400
 - rear panel components, drive frame 32 to ??
 - rebooting library 333
 - redundancy
 - drive connectivity 68
 - network connectivity 66 to 68
 - power supplies 69
 - robotic connectivity 66 to 68
 - refresh display
 - setting refresh rate 100
 - status bar button 79
 - time of last update 79
 - updating information 79
 - regulations, safety compliance 498
 - regulatory agency compliance 497 to 501
 - remaining capacity
 - in MLM reports 275
 - reported for MLM-enabled cartridges 248
 - shown on General Status screen 252
 - remote access, *See* web interface
 - Remote Library Controller (RLC), *See* web interface
 - remote support, description 80
 - remove/replace
 - drive 443
 - repair, RMA policy 450
 - reports, DLM
 - generating 293 to 295
 - saving for DLM 295
 - reports, MLM
 - Born on Date 275
 - Cleans Remaining 275
 - Exported Media 275
 - generating 273 to 278
 - Last Write/Read Time 275
 - Load Count 275
 - Media Health 275
 - Remaining Capacity 275
 - saving 278 to 280
 - Write Errors 275
 - requirements
 - barcode labels 492 to 496
 - environmental, library 482
 - environmental, tape media 490
 - network cables 485
 - power 479 to 480
 - Reset Controller utility, using 335 to 336
 - resetting
 - caution after firmware update 406
 - caution, trace data 333
 - drives 351
 - LCM or RCM 334
 - library 333
 - RIM or F-QIP 335 to 336
 - restore
 - library
 - configuration 340 to 348
 - MLM & DLM databases 348
 - Retrieve Drive Dump utility for retrieving drive dump file 361
 - returns, using an RMA 450
 - RIM
 - component identifier 57
 - connectivity for robotics 59 to 64

- controller failover
 - operation 66 to 68
 - fabric mode in partition
 - configuration 186
 - Fibre Channel port
 - usage 63 to 64
 - hardware reset 335
 - location 32
 - port visibility, robotics 184
 - reset button 335
 - reset using Reset Controller utility 335 to 336
 - See also* connectivity
 - See also* controller failover
 - RIMs
 - port addressing for partition ?? to 186
 - RLC
 - description 72
 - See also* remote access
 - See also* web interface
 - RMA numbers, using 450
 - robotics
 - configuring robotic control path 172
 - connectivity through controller 59 to 64
 - control path provided by RIM 60, 61
 - control path, configuring 172
 - power, status LED 34
 - RIM port visibility 184
 - selecting control path 172
 - Robotics Control Module, *See* RCM
 - Robotics Status screen,
 - accessing 74
 - Rotation Manager
 - configuring 133 to 135
 - description 133
 - routine maintenance option,
 - configuring 115
 - Run All Motion Basic Tests diagnostic
 - accessing 74
 - running 337 to 339
-
- S**
- safety agency compliance 498
 - sales, contacting 7
 - SAS
 - connector specification 485
 - Save Library Configuration utility,
 - using 136 to 138
 - SCD codes
 - displayed on the Drive Details screen 366
 - LTO-3 through LTO-6 drives 366 to 374
 - multiple errors 367
 - permanent errors 367
 - WORM media errors 367
 - SD memory card, *See* memory card
 - security
 - configuring users 90
 - default users 90
 - groups 90
 - privileges 90
 - security certificate, creating for use with SSL 112
 - Security toolbar, options 76
 - security, provided by configuring users 81, 90
 - Send Log Sets
 - configure 301 to 305
 - description 298
 - sense codes
 - drives, lookup on website 315, 362
 - serial number
 - drive 153
 - library 98
 - See also* hardware ID
 - servers, update packages 129 to 131
 - service access, space requirements 478
 - service contract
 - BlueScale Software Support, renewing 386
 - entering BlueScale Software Support key 97 to 98
 - extending or renewing 386 to 387, 468
 - required for BlueScale update 469
 - See also* BlueScale Software Support key
 - Shared Library Services, *See* SLS
 - shipping
 - library environment 483
 - RMA on return label 450
 - shock and vibration limits,
 - library 484
 - slots
 - description 31
 - upgrading capacity 96, 470
 - SLS
 - activation key requirements 96, 164
 - description 52
 - purchasing 470
 - See also* partitions
 - SMTP address, setting 108
 - SNMP
 - enable and configure 116 to 118
 - enabling and configuring 102
 - version implemented in library 102
 - soft keyboard
 - description 71
 - on touch screen 87
 - using 85
 - using to troubleshoot operator panel display problems 318
 - Soft Power
 - description 143
 - enabling or disabling 102
 - using 143 to 144
 - software
 - license agreement 3
 - software support key, *See* BlueScale Software Support key
 - software, BlueScale
 - backup configurations before updating 394
 - BlueScale Software Support key requirement 95
 - BlueScale Software Support key, renewing 386
 - check release notes for updated information 388
 - configuring a package server 129 to 131
 - current version 79

- download to USB device 393, 427
- expired BlueScale Software Support key 386
- managing packages 408
- package update procedure 388 to 406
- renewing BlueScale Software Support key 386 to 387
- support requirements for updates 469
- supported browsers 72
- supported packages 388
- updating RCM using USB device 400
- upgrade policy 469
- upgrading from a USB device 397, 430
- viewing current version 79, 389
- specifications
 - AC power connectors 479
 - AC power cord 479
 - barcode labels 492 to 496
 - cooling requirements 481
 - data capacity 474
 - environmental, library 482
 - environmental, tape media 490
 - heat dissipation 481
 - LTO media capacity 491
 - LTO tape drives 486 to ??
 - multi-frame space requirements 477
 - power 479 to 480
 - power consumption 481
 - SAS connector 485
 - service access space requirements 478
 - shipping size and weight 478
 - shock and vibration limits, library 484
 - size and weight 477
 - TS11xx technology media capacity 491
 - TS11xx technology tape drives 489
- Spectra Certified Media
 - CarbideClean 466
 - cleaning cartridges 467
 - description 466
 - MLM-enabled 244
 - purchasing 468
- Spectra Logic
 - contacting 7
- Spectra Logic Technical Support portal, *See* portal
- Spectra LS
 - description 39 to ??
 - memory cards 40
 - See also* RCM
- Spectra PC and Spectra LS
 - description ?? to 41
 - See also* LCM
- Spectra SKLM key management
 - assigning to a partition 181
- SSL
 - creating a security certificate 112
 - enabling 102
 - entering security certificate into library 113
 - logging into the library 84
- status
 - attention required, system 78
 - attention, drive health 292
 - average, media health 276
 - error, system 78
 - for drives 153
 - General Status screen 74
 - good, drive health 292
 - good, media health 276
 - information notification 78
 - library messages 146
 - on General Status screen 74
 - on pre-login General Status screen 83
 - poor, drive health 292
 - poor, media health 277
 - System OK 78
 - unknown, media health 277, 292
 - using status bar 78
- status bar
 - BlueScale software version 389
 - description 78
 - refresh display 78
 - remote access icon 80
 - system status icon 78
 - time of last refresh 79
- status icons, descriptions 78
- status LED
 - LTO drives 366
 - power supply module, drive frame 35
 - power supply, robotics 34
- storage density, viewing metrics 151
- storage partitions, architecture 52
- storage partitions, configuring
 - assign chambers and drives 176
 - Auto Drive Clean icon 189
 - creating automatically 170
 - initial settings 169 to 171
 - minimum drive and slot requirements 52
 - name and media type 172
 - new 169 to 186
- storage partitions, moving cartridges
 - create move queue manually 232 to 235
 - processing move queue file 240 to 242
 - using move queue file 237 to 239
 - See* move queue, cartridges
- storage partitions, using
 - exchange magazines 212 to ??
 - export magazines 211 to ??
 - import magazines 202 to ??
 - import magazines, first time 202
 - prepare for imports 205
 - requirements for importing into entry/exit pool 203
 - requirements for importing into storage pool 203
 - software-based drive cleaning 204
 - user privilege to import or export cartridges 201
 - See also* export or exchange media
 - See also* import media
- storage pool
 - configuring 176 to 177
 - description 50
 - empty chambers 203
 - exchange magazines 212 to ??

- export magazines 211 to ??
 - import magazines 202 to ??
 - importing media for first time 203
 - prepare for imports 205
 - requirements for importing 203
 - view inventory 224 to 227
 - storing cartridges, best practices 461
 - storing the library, environmental requirements 483
 - stylus, location 37
 - su, *See* superuser
 - subnet mask
 - library 105
 - setting for library 105, 106
 - superuser
 - default user name and password 91
 - deleting last 93
 - privileges 91
 - support ticket
 - opening 447
 - sending 447
 - Switch User, using to change users or log out 86
 - Syslog messaging
 - configuring server IP address 103
 - enabling/disabling 103
 - message format 148
 - using 148
 - system
 - change global settings 99 to 111
 - configuration defaults 100 to 103
 - system messages
 - date and time stamp 110
 - generated by PreScan and PostScan 250
 - HHM notification 324
 - icons 78
 - icons, MLM media health severity definitions 276
 - System OK icon 78
 - System Setup screen, accessing 75, 93
-
- T**
- TAP
 - correct orientation for a magazine 208
 - description 38
 - tape drives, *See* drives
 - tape media
 - environmental specifications 490
 - MLM-enabled 244
 - See also* cartridges
 - tape rotation
 - example 463 to 465
 - using Rotation Manager 133
 - technical support
 - accessing the Technical Support portal 444 to 446
 - BlueScale software updates 469
 - contacting 7
 - creating a portal account 445
 - service options 315, 362
 - using
 - AutoSupport 308 to 313
 - using Knowledge Base 315, 362
 - See also* portal
 - TeraPack Access Port, *See* TAP
 - TeraPack case or container
 - See* magazines
 - See* TeraPack magazine
 - TeraPack magazine
 - capacity 198
 - cover 461
 - description 46
 - inserting cartridges 200
 - pre-loaded media 467
 - storage density 31
 - See also* cartridges
 - See also* magazines
 - See also* Maintenance TeraPack magazine
 - See also* media
 - throughput, *See* transfer rate
 - time
 - in status bar 78
 - setting 110
 - toolbar options map 77
 - toolbars
 - Configuration options 75
 - General, options 74
 - Maintenance 76
 - Security 76
 - touch screen
 - calibrating 410
 - description 37
 - touch screen interface
 - description 71
 - features 73 to 80
 - logging in 82 to 86
 - logging out 86
 - soft keyboard description 71
 - using 82 to 87
 - using soft keyboard 87
 - traces
 - capturing 330 to 332
 - displaying in a separate screen 332
 - emailing results 331
 - saving to USB device 331
 - transfer rate
 - LTO-6 drive 488
 - LTO-7 drive 487
 - LTO-8 drive 487
 - TS1150 technology drive 489
 - TS1155 technology drive 489
 - transporter
 - description 31
 - power supply modules, description 34
 - troubleshooting, drives
 - host cannot access drive 364
 - host cannot read/write data 363
 - identify problem 362 to 364
 - library error sense codes 315, 362
 - LTO status LED 366
 - LTO WORM media 367
 - LTO-3 through
 - LTO-6 366 to 374
 - permanent errors, LTO-2 through LTO-6 367

- retrieving drive trace files 357 to 362
 - TS11xx technology 374 to 378
 - using DLM drive test 379 to 383
 - troubleshooting, library
 - BlueScale interface issues 316 to 318
 - calibrate touch screen 410
 - capturing traces 330 to 332
 - chambers marked as unusable 322
 - check firmware levels 389 to 391
 - collect trace data before resetting 333
 - encryption 320
 - encryption issues 320 to 321
 - encryption moniker 320
 - encryption server 320
 - general 315
 - general information 314
 - magazine in TAP after power failure 322
 - MLM issues 319
 - power-cycle reset 333
 - recovering media in TAP after power failure 322
 - resetting a RIM or F-QIP 335 to 336
 - resetting the LCM or RCM 334
 - running the Run All Motion Basic Tests 337 to 339
 - Spectra SKLM requirements 320
 - using Knowledge Base 315, 362
 - TS11xx technology
 - cartridge capacities 491
 - drive specifications 489
 - troubleshooting drive 374 to 378
 - typing
 - using external keyboard 88
 - using soft keyboard 87
 - using the web interface 87
 - typographical conventions 21
-
- ## U
- Ultrium, *See* LTO
 - Universal Serial Bus (USB)
 - See* USB device
 - See* USB port
 - unknown status
 - drive health 292
 - media health 277
 - update drive firmware, preparation 419 to 423
 - Upgrade Drive Firmware Utility
 - using 437 to 440
 - upgrades to BlueScale software, policy 469
 - upgrades, library
 - adding capacity 96, 470
 - BlueScale software options 469
 - hardware components 471
 - how to order 472
 - purchasing capacity 96, 470
 - requirements when purchasing 98, 472
 - USB device
 - connecting to operator panel or LCM 158
 - saving traces to 331
 - using for BlueScale upgrade 397, 430
 - using to save drive trace files 359
 - USB port
 - interface support 486
 - using for BlueScale upgrade 393, 427
 - user groups
 - overview 81, 90
 - privileges 90, 91
 - user interface
 - accessing 71 to 73
 - attention required notification 78
 - command processing progress bar 80
 - Configuration toolbar options 75
 - error notification 78
 - feature overview 23 to 27
 - features 73 to 80
 - General toolbar options 74
 - HHM notification 80
 - information notification 78
 - logging in 82 to 86
 - logging out 86
 - Maintenance toolbar options 76
 - map of toolbar options 77
 - moving cartridges within a partition 231 to 242
 - refreshing displayed information 79
 - Security toolbar options 76
 - setting date and time 110
 - soft keyboard 71
 - status bar 78
 - System OK notification 78
 - typing, soft keyboard 87
 - typing, using external keyboard 88
 - typing, web browser 87
 - using 82 to 88
 - web 41
 - XML 41
 - user privileges required to
 - access DLM 289
 - access drives screen 413
 - activate or reclaim Global Spare drive 353
 - add, modify, or delete users 90, 91
 - back up MLM database 282
 - calibrate touch screen 410
 - capture traces 330, 337
 - configure a firmware package server 129, 132
 - configure AutoSupport 300
 - configure controller failover 119
 - configure emulation 122
 - configure MLM 260
 - configure Rotation Manager 134
 - create HHM AutoSupport ticket and view HHM data 324

- create or modify storage and cleaning partitions 160
 - delete MLM database records 285
 - download MLM database 287
 - enable and configure MLM 253
 - enable options or change system configuration settings 94
 - enable/disable Soft Power 102
 - export MLM database 296
 - generate MLM reports 260
 - manage firmware packages 408
 - manually back up the library configuration 137
 - modify barcode reporting 125
 - monitor the library 145
 - move cartridges within a partition 232
 - open or modify support tickets through AutoSupport 308
 - perform a DLM Drive Health test 380
 - reset a drive using BlueScale 351
 - reset RIM using BlueScale 335, 353
 - restore library configuration 340
 - restore MLM and DLM databases 340
 - restore MLM database 348
 - retrieve a drive trace file 358
 - update BlueScale firmware and software 388
 - update drive firmware 420
 - use advanced import/export options 216
 - use Soft Power 143
 - view or download cartridge inventory 224
- users
- adding new 91
 - changing logged in 86
 - configure partition access 184
 - configuring 90 to 93
 - configuring for library security 81, 90
 - deleting 93
 - deleting last superuser 93
 - logging in 82 to 86
 - logging out 86
 - modifying existing 93
 - overview 81, 90
 - types of privileges 91
- utilities
- calibrate touch screen 410
 - current firmware levels 390
 - HHM: View Data 328 to 329
 - overview 24
 - Reset Controller, to reset RIM 335 to 336
 - Restore Library Configuration 346 to 348
 - Restore Library Configuration from Auto Save 342 to 344
 - Retrieve Drive Dump, to retrieve drive dump file 361
 - Save Library Configuration 136 to 138
-
- V**
- verifying configuration backup file 139
 - virtual library, *See* partitions
 - virtualization
 - description 52
 - See also* partitions
 - See also* SLS
 - visibility, robotic control path on RIM ports 184
 - voltage, AC input for library 479
-
- W**
- warnings
 - security certificate 112
 - warranty and service options 315, 362
 - web interface
 - available functions when using 87
 - creating a security certificate 112
 - description 72
 - entering information 87
 - features 73 to 80
 - logging in 82 to 86
 - logging in using SSL 84
 - logging out 86
 - supported browsers 72
 - use toolbar to navigate through screens 72
 - using 82 to 88
 - See also* user interface
 - web server
 - communication port 100
 - in LCM 41
 - reserved port number 100
 - website
 - drive sense code lookup 315, 362
 - host software interoperability tables 484
 - Spectra Logic 7
 - World Wide Name, *See* WWN
 - WORM media
 - description 492
 - SCD codes for media errors 367
 - write errors, reported by MLM 275
 - write-protect switch, setting for cartridges 199
 - WWN
 - assigned to partition 156
 - Fibre Channel drives 65, 155
 - partition 62
 - partitions, when using both controller Fibre Channel ports 62